



## Main

Range of product	Telemecanique Inductive proximity sensors XS
Series name	General purpose
Sensor type	Inductive proximity sensor
Sensor name	XS4
Sensor design	Cylindrical M30
Size	70 mm
Body type	Fixed
Detector flush mounting acceptance	Non flush mountable
Material	Plastic
Type of output signal	Discrete
Wiring technique	2-wire
[Sn] nominal sensing distance	15 mm
Discrete output function	1 NC
Output circuit type	AC/DC
Electrical connection	Male connector 1/2"20 UNF, 3 pins
[Us] rated supply voltage	24...240 V AC/DC 50/60 Hz
Switching capacity in mA	5...200 mA DC 5...300 mA AC
IP degree of protection	IP67 conforming to IEC 60529

## Complementary

Thread type	M30 x 1.5
Detection face	Frontal
Front material	PPS
Enclosure material	PPS
Operating zone	0...12 mm

Differential travel	1...15% of Sr
Status LED	Output state: 1 LED (yellow)
Supply voltage limits	20...264 V AC/DC
Maximum residual current	0.6 mA open state
Switching frequency	<= 1000 Hz DC <= 25 Hz AC
Maximum voltage drop	<5.5 V (closed)
Maximum delay first up	40 ms
Maximum delay response	0.2 ms
Maximum delay recovery	0.4 ms
Marking	CE
Threaded length	52 mm
Height	30 mm
Length	70 mm
Net weight	0.08 kg

## Environment

Product certifications	Ecolab CSA UL CCC
Ambient air temperature for operation	-25...70 °C
Ambient air temperature for storage	-40...85 °C
Vibration resistance	25 gn amplitude = +/- 2 mm (f = 10...55 Hz) conforming to IEC 60068-2-6
Shock resistance	50 gn for 11 ms conforming to IEC 60068-2-27

## Packing Units

Unit Type of Package 1	PCE
Number of Units in Package 1	1
Package 1 Weight	89 g
Package 1 Height	4.1 cm
Package 1 width	6.4 cm
Package 1 Length	9.4 cm
Unit Type of Package 2	BAG
Number of Units in Package 2	1
Package 2 Weight	89 g
Package 2 Height	3 cm
Package 2 width	25 cm
Package 2 Length	20 cm
Unit Type of Package 3	S01
Number of Units in Package 3	22
Package 3 Weight	2.183 kg
Package 3 Height	15 cm
Package 3 width	15 cm
Package 3 Length	40 cm

## Offer Sustainability

Sustainable offer status	Green Premium product
REACH Regulation	<a href="#">REACH Declaration</a>
EU RoHS Directive	Pro-active compliance (Product out of EU RoHS legal scope) <a href="#">EU RoHS Declaration</a>
Mercury free	Yes
RoHS exemption information	<a href="#">Yes</a>

---

Environmental Disclosure	<a href="#">Product Environmental Profile</a>
Circularity Profile	<a href="#">End of Life Information</a>

---

### Contractual warranty

---

Warranty	18 months
----------	-----------

---

Dimensions

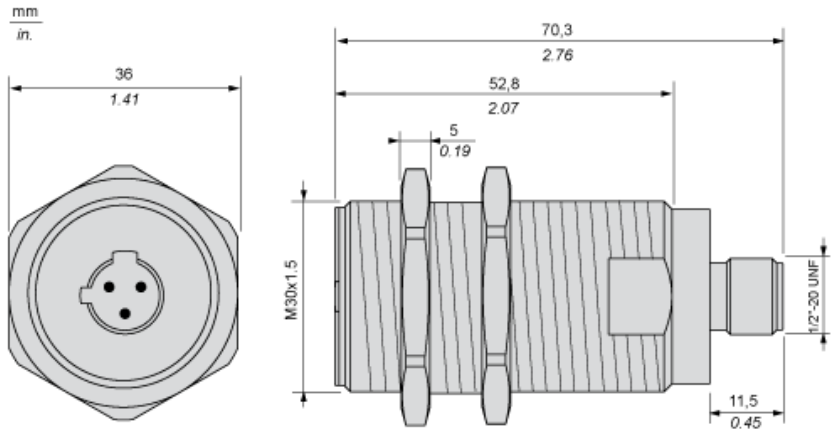

Minimum Mounting Distances

Side by side

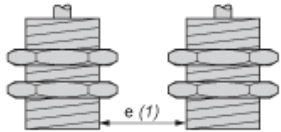

$e (1) \geq 60 \text{ mm}/2.36 \text{ in.}$

Face to face

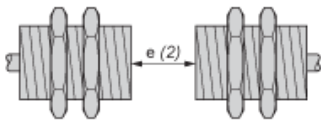

$e (2) \geq 180 \text{ mm}/7.09 \text{ in.}$

Facing a metal object

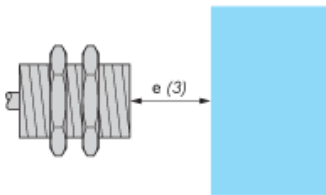

$e (3) \geq 45 \text{ mm}/1.77 \text{ in.}$

Mounted in a metal support

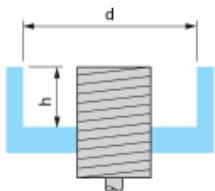

$d \geq 90 \text{ mm}/3.54 \text{ in.}$

$h \geq 30 \text{ mm}/1.18 \text{ in.}$

Wiring Schemes

1/2"-20UNF

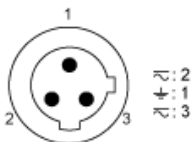

- 1 : Grounding
- 2 : AC
- 3 : AC

NC output

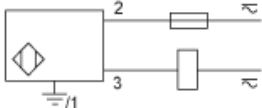

---

Performance Curves

---

Standard Steel Target : 45x45x1 mm

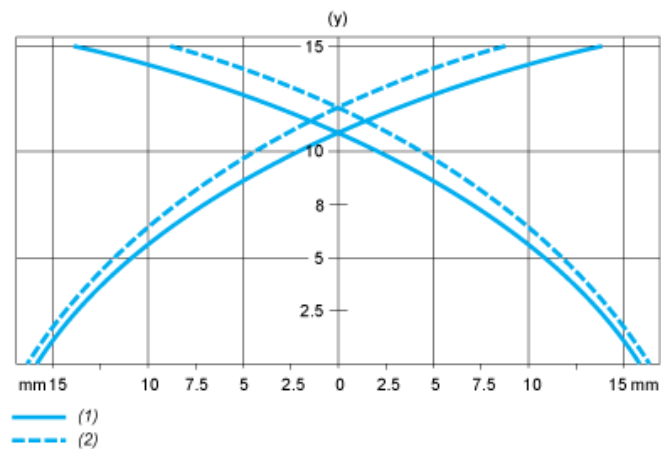

- (1) Pick-up points
- (2) Drop-out points (object approaching from the side)
- (y) Sensing distance in mm