

OPERATOR'S MANUAL



- Introduction 1**
 - Features 1
 - Specifications 2
 - Storage 2
 - Battery 3
 - Switchpad Functions 3

- Quick Start Guide 5**
 - Selecting Grain 5
 - Grain Sample Testing 5

- Settings 7**
 - Languages 7
 - Results 9
 - Average 10
 - Backlighting 10
 - Contrast 11
 - Units 12
 - Power 12

- Normal Operation 15**
 - Measuring Moisture 15
 - Grain Sample Testing 16
 - Auto Ranging 19
 - Average 19
 - Bias 21
 - History 22

- Updating Grain Calibrations 23**

- Accuracy 25**
 - Condensing Samples 25
 - High Moisture Grains 25
 - Improving Grain Test Results 26

- Error Codes 27**

- Diagnostics 31**
 - Information 31

OPERATOR'S MANUAL



OPERATOR'S MANUAL



INTRODUCTION

The mini GAC® models of grain testers are portable units that quickly test grain and automatically calculate moisture content and test weight/bulk density (mini GAC plus only) of the sample. The unit operates using four function keys coupled with a menu-driven operating system.

The mini GAC portable tester offers:

- Moisture readings

The mini GAC **plus** portable tester offers:

- Moisture readings
- Test weight readings

FEATURES

- Plastic loading cup (Loader)
- 9V alkaline battery (included)
- LCD digital display
- Multiple languages
- Backlit display
- Memory for up to 20 product (grain) tests per language
- English/Metric units
- Belt clip
- Carrying case
- USB port for calibration loading
- No screw cap or sample preparation required

Figure 1

mini GAC

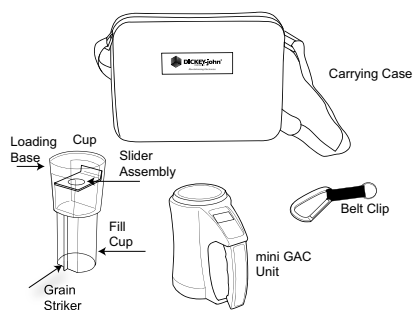

OPERATOR'S MANUAL



SPECIFICATIONS

Operating Temperature Range: 40 - 113 degrees F,
(5 - 45 degrees C)

Validated Grain Temperature Range: 40 - 113 degrees F
(5 - 45 degrees C)

Operating Grain Temperature Range: 32 - 122 degrees F
(0 - 50 degrees C)

Recommended Maximum Temperature Difference (between
analyzer and grain): 36 degrees F (20 degrees C)

Humidity: 5-95%, noncondensing

Weight: 2 lbs 7 oz (1.1 Kg)

Power Source: A 9V alkaline battery is included. A low battery
indicator on display will identify when replacement is necessary.

STORAGE

The Loader should be turned upside down and placed inside the
unit for storage.

Figure 2

Loader/Unit Storage

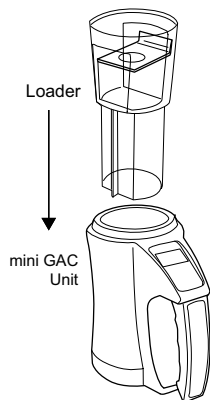

OPERATOR'S MANUAL



Low Battery

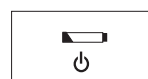

Dead battery

BATTERY

A 9V alkaline battery is installed in the unit. A **low battery voltage** menu will appear when battery life has almost reached capacity. The unit is still capable of making accurate measurements, but the battery should be replaced soon.

A **dead battery warning** displays when the battery has reached its end of life and is no longer capable of making accurate measurements. The unit will no longer perform any functions other than to power off the device. If a dead battery warning displays prior to saving some settings, the information could potentially be lost.

Battery life can be prolonged by reducing the **Power Down** setting of inactivity. The power down setting range is selectable from 10 to 90 seconds. The default setting is 90 seconds.

SWITCHPAD FUNCTIONS



on/off
home

ON/OFF/HOME

The **On/Off/Home** button is pressed momentarily to power the unit On and held for 2 seconds to power the unit Off.

Pressing the **Home** button on any page will discard any changes and return to the Home menu.



Enter button

ENTER

The **Enter** button is pressed to start a measurement from the Home menu. The Enter button is also used to make a menu selection, and if applicable, save the selection and return to the Home menu.



UP AND DOWN ARROW BUTTONS

The **Up and Down Arrow** buttons are used to scroll through the items on the menu.

(Figure 3) illustrates the Switchpad area.

OPERATOR'S MANUAL



Figure 3
Switchpad

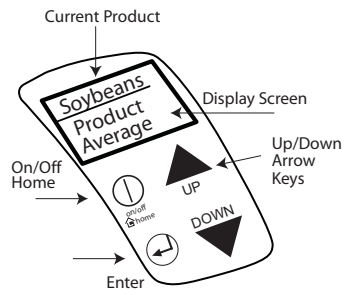

OPERATOR'S MANUAL



QUICK START GUIDE

IMPORTANT: The cell must be empty and the loading cup removed before turning the unit ON and during all testing (progress bar indicates when testing).

SELECTING GRAIN

1. Press the **On/Off/Home** button to power on the unit.
2. To select a grain type, press the **Down Arrow** button to position cursor at the product heading and press **Enter**.
3. Select a product (grain) using the **Up or Down Arrow button** and press **Enter**.
4. The selected grain will appear at the top of the display.

GRAIN SAMPLE TESTING

1. **Ensure Loader is removed from the top of the unit.**
2. With the product name selected at the top of the display, press the **Enter** button.
3. The cell must be empty, upright, and still to perform an empty cell test. When the Empty Cell menu displays, press the **Enter** button.

IMPORTANT: The empty cell reference measurement is used for all product testing until the unit is powered off. It is critical that the cell be clean and completely empty when the unit is on. Keep the measurement cell opening clear of hands or other objects during this period.

4. After the empty cell test completes, the **Fill Cell** menu displays.
5. With the slide closed, scoop or pour grain into the Loader over the minimum fill line as shown in (Figure 13).
6. Place the Loader on top of the unit.
7. When secured, pull Loader slide out to dispense grain into the unit.
8. **Remove the Loader and use the level edge to strike any excess grain from the unit.**
9. Press **Enter** to begin the test.

OPERATOR'S MANUAL



IMPORTANT: A slight tilt when holding and testing grain is acceptable. If tilt is more than 10 degrees, an error warning is possible.

10. When grain test completes, press **Enter** to store the results. Press **Enter** again to see the average of all samples and press the **Up or Down Arrows** to scroll through all previous readings.
11. Press the **Home** button to return to the Home menu.

IMPORTANT: Refer to the **Error Codes and Troubleshooting** section if an error displays after a grain test.

Figure 4

Scoop, Pull Slide, Strike Grain

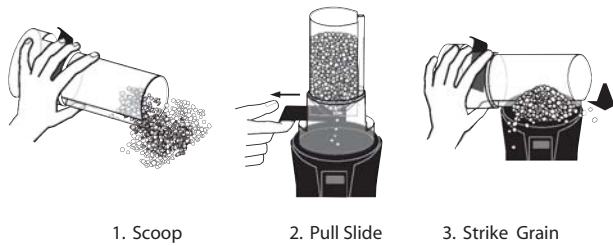

OPERATOR'S MANUAL



SETTINGS

The mini GAC can be customized to user preferences by changing the following control settings from the Setup menu:

- Languages
- Results - test weight and temperature (mini GAC plus)
- Display
- Average buffer size
- Backlighting
- Contrast
- Units of measurement
- Automatic power down

LANGUAGES

Up to 12 languages are supported in each version of the mini GAC with each language conforming to its own set of calibrations. Other languages will be added when available.

Languages	
English US	Dutch
English UK	Polish
English AUS	Danish
French	Russian
French Canadian	Turkish
German	Czech/Slovak
Italian	Romanian
Spanish	Greek
Portuguese	Finish
Hungarian	Bosnian/Croatian/Serbian
Bulgarian	

To change the Language setting:

1. From the Home menu, press the **Down Arrow** button and scroll to **Setup** and press **Enter**.
2. Press **Enter** to select the Language menu.
3. Press the **Up or Down Arrow** button to scroll through languages.

OPERATOR'S MANUAL



4. Press **Enter** to accept the desired language.
5. Any **Averages** and **History** stored will be cleared when the language setting is changed. Press the **Enter** button to acknowledge or the **On/Off/Home** button to escape and retain averages and history.

Figure 5

Modifying Language Settings

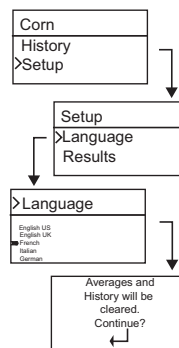

OPERATOR'S MANUAL



RESULTS (MINI GAC PLUS ONLY)

The **Results** menu is only available on the mini GAC plus testers. The Results menu controls the appearance of test weight and product temperature results for each measurement on the Test Results menu. The default is set to **Show** results.

To change the Results setting:

1. From the Home menu, press the **Down Arrow** button and scroll to **Setup** and press **Enter**.
2. Scroll and press **Enter** to select the **Results** menu.
3. Select either **Test Weight** or **Temperature**.
4. Select either **Show** (to display results) or **Hide** (to disable results).
5. Press the **Enter** button to save the changed setting or the **On/Off/Home** button to escape and retain the previous setting.

Figure 6

Modifying Results Setting (mini GAC plus only)

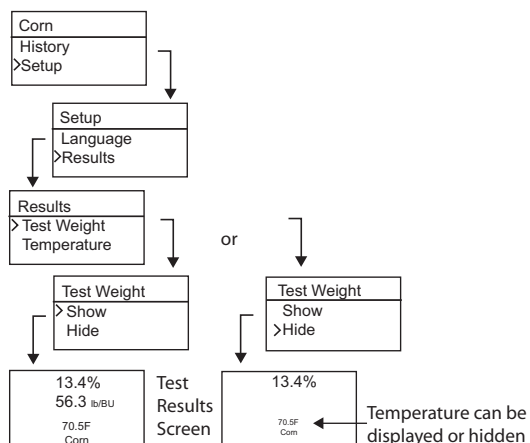

IMPORTANT: The mini GAC model does not have the **Results** menu and automatically displays the product temperature and cannot be disabled. Test Weight is also not available.

OPERATOR'S MANUAL



AVERAGE

Averages for up to 20 products are stored in the unit. Individual results correlate with a specific product, moisture result, product temperature and/or test weight. The number of stored memories that appear on the test results menu can be altered to show a minimum of 2 up to a maximum of 10 memory readings. The factory default setting is 3 stored memories, refer to (Figure 7).

To change the Memory Storage setting:

1. From the Home menu, press the **Down Arrow** button and scroll to **Setup** and press **Enter**.
2. Scroll and press **Enter** to select the **Average** menu.
3. Press the **Up or Down Arrow** button to increase or decrease the number of buffers to appear on the menu.
4. Press the **Enter** button to save the changed setting or the **On/Off/Home** button to escape and retain the previous setting.

Figure 7

Modifying the Average Buffers Setting

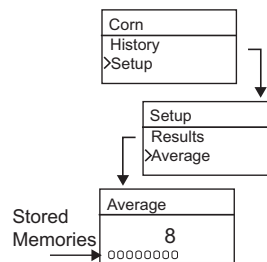

BACKLIGHTING

Backlighting can be turned On or Off. The factory default setting is backlighting Off. Turning on the backlighting can compensate for low lit areas or can make the text appear sharper. Unnecessary use of backlighting will decrease battery life.

To change the Backlight setting:

1. From the Home menu, press the **Down Arrow** button and scroll to **Setup** and press **Enter**.
2. Scroll and press **Enter** to select the **Backlight** menu.
3. Press the **Up or Down Arrow** button to turn backlighting on or off.

OPERATOR'S MANUAL



4. Press the **Enter** button to save the changed setting or the **On/Off/Home** button to escape and retain the previous setting.

Figure 8

Modifying Backlight Setting

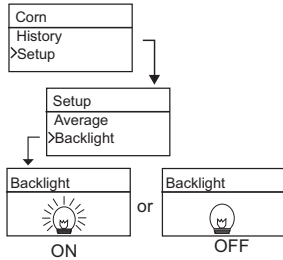

CONTRAST

The display menu contrast can be adjusted on a scale from 10 to 36; 36 being the most intense.

To change the Contrast setting:

1. From the Home menu, press the **Down Arrow** button and scroll to **Setup** and press **Enter**.
2. Scroll and press **Enter** to select the **Contrast** menu.
3. Press the **Up or Down Arrow** button to change the contrast of the display. The display will reflect the changes as the number is altered.
4. Press the **Enter** button to save the changed setting or the **On/Off/Home** button to escape and retain the previous setting.

Figure 9

Modifying Display Contrast

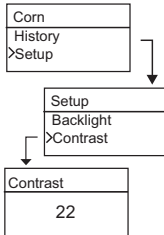

OPERATOR'S MANUAL



UNITS

Units of Measurement can be changed to either English (Lbs/Bu) or Metric (Kg/HL).

To change the Units setting:

1. From the Home menu, press the **Down Arrow** button and scroll to **Setup** and press **Enter**.
2. Scroll and press **Enter** to select the **Units** menu.
3. Press the **Up or Down Arrow** button to select English or Metric.
4. Press the **Enter** button to save the changed setting or the **On/Off/Home** button to escape and retain the previous setting.

Figure 10

Modifying Units Setting

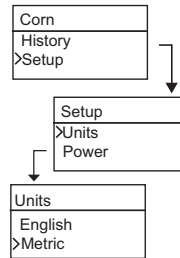

POWER

The **Power** setting offers several power off durations that will shut down the unit after so many seconds of inactivity. The default factory setting is 90 seconds.

Power off durations available:

- 10 seconds
- 15 seconds
- 20 seconds
- 30 seconds
- 45 seconds
- 60 seconds
- 90 seconds
- Infinite (manual shut off)

OPERATOR'S MANUAL



To change the Power setting:

1. From the Home menu, press the **Down Arrow** button and scroll to **Setup** and press **Enter**.
2. Scroll and press **Enter** to select the **Power** menu.
3. Press the **Up or Down Arrow** button to select a power down time.
4. Press the **Enter** button to save the changed setting or the **On/Off/Home** button to escape and retain the previous setting.

Figure 11

Modifying the Power Down Settings

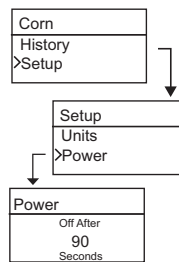

OPERATOR'S MANUAL



OPERATOR'S MANUAL



NORMAL OPERATION

The Home menu will appear immediately after all startup self tests successfully complete. This is the “Home” menu through which all other menus are accessed.

MEASURING MOISTURE

In preparation for testing grain, the following conditions should be observed.

1. The cell **MUST** be empty and clean prior to testing for accurate, consistent measurements.
2. The Loader **MUST** be removed before turning the unit On and during all testing (hour bar indicates when testing), refer to (Figure 14).

IMPORTANT: The loader should only be in or on the unit during storage and when grain is loaded.

The Home menu will display the active grain at the top of the Home screen.

SELECTING GRAIN

To select a new grain:

1. Press the **Down Arrow** button to position the cursor at the Product heading and press **Enter**.
2. Select a product (grain) using the **Up or Down Arrow** button (to check a grain's calibration constant, remain on a selected grain for approximately 3 seconds and the calibration constant menu will display. Pressing the **Down Arrow** button will scroll to the next Constant menu and the Bias menu) or immediately press the **Enter** or **Home** button to save and change the selection.

After grain selection, the new product (grain) will display at the top of the Home menu. The grain list on the grain selection menu will be saved in a “last used” order.

IMPORTANT: Periodic updates of the calibration constants are recommended. Reference the Calibration Grain Values section for additional information.

OPERATOR'S MANUAL



Figure 12
Grain Selection Menus

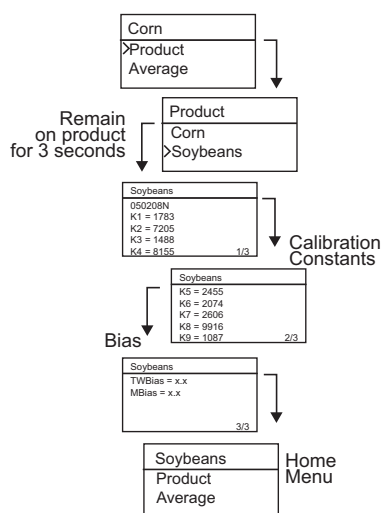

GRAIN SAMPLE TESTING

To begin Grain Test:

1. Ensure Loader is removed from the top of the unit.
2. With the product name selected at the top of the display, press the **Enter** button.
3. The cell must be empty, upright, and still to perform an empty cell test. When the Empty Cell menu displays, press the **Enter** button.

IMPORTANT: The empty cell reference measurement is used for all product testing until the unit is powered off. It is critical that the cell be clean and completely empty when the unit is on. Keep the measurement cell opening clear of hands or other objects during this period.

4. After the empty cell test completes, the **Fill Cell** menu displays.
5. With the slide closed, scoop or pour grain into the Loader over the minimum fill line as shown in (Figure 13).
6. Place the Loader on top of the unit.

OPERATOR'S MANUAL



7. When secured, pull Loader slide out to dispense grain into the unit.
- 8. Remove the Loader and use the level edge to strike any excess grain from the unit.**
9. Press **Enter** to begin the test.

IMPORTANT: A slight tilt when holding and testing grain is acceptable. If tilt is more than 10 degrees, an error warning is possible.

10. When grain test completes, press **Enter** to store the results. Press **Enter** again to see the average of all samples and press the **Up or Down Arrows** to scroll through all previous readings.
11. Press the **Home** button to return to the Home menu.

IMPORTANT: Refer to the **Error Codes and Troubleshooting** section if an error displays after a grain test.

Figure 13

Scoop, Pull Slide, Strike Grain

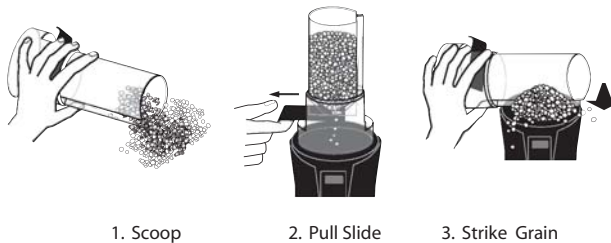

OPERATOR'S MANUAL



Figure 14
Testing Grain

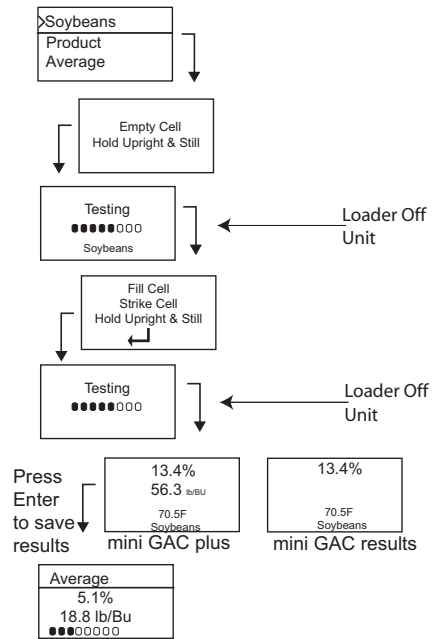

IMPORTANT: Refer to the Accuracy section for improving grain test results.

OPERATOR'S MANUAL



AUTO RANGING

Auto Ranging is an automatic feature that occurs when grain tests out of the calibration limits (high or low) for the current grain selection. If a product tests out of the moisture range of the selected product, the mini GAC will look for a higher or lower grain calibration and give the option to choose the correct calibration. This typically occurs with corn.

A screen will automatically display to re-test the grain at the correct calibration values (Figure 15). The new test will be saved to the correct grain selection eliminating the need to dump the grain and start a new test. All proceeding products will be tested to the last grain selection unless the product tests out of that range.

1. Press **Enter** at the Auto Range display to switch to the high or low grain selection.
2. Press **On/Off/Home** button to reject the analysis.

Figure 15

Auto Ranging

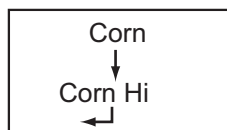

AVERAGE

Grain Test Results

The Average menu allows test results to be added, read, or cleared from the unit. Up to 10 values can be stored for each grain. If all memory indicators are full when adding new test results, the test results in location 1 will be replaced with the new test results. The factory default setting is 3 values (refer to Figure 16).

IMPORTANT: Changing the language will reset the memory and all saved grain tests results will be cleared.

OPERATOR'S MANUAL



To view the Average menu:

1. From the Home menu, press the **Down Arrow** button and scroll to **Average** and press **Enter**.
2. Scroll and select desired function and press **Enter** to display menu.

IMPORTANT: Test Weight does not display on the mini GAC model.

Add To

The **Add To** function manually enters the last test result to memory.

New

Selecting the **New** function will clear all previous test results for the product selected and place the new test result in the first position of the new group of readings.

Read

The **Read** function displays the saved test results for the active grain. Pressing the **Up or Down Arrow** button cycles through the saved test results.

Clear

The **Clear** function removes all test results for the active grain.

Figure 16

Averages Menu

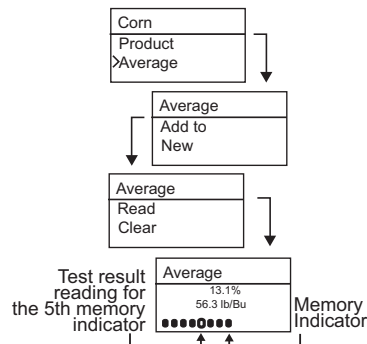

OPERATOR'S MANUAL



BIAS

The mini GAC uses the same grain constants as the DICKEY-john federal standard GAC2100 and is calibrated to USDA certification.

In situations where moisture or test weight differences occur with a local elevator, the Bias function allows entering of a correction factor in moisture and test weight to compensate for those differences.

IMPORTANT: Test Weight does not display on the mini GAC model.

To change the Moisture or Test Weight Bias setting:

1. From the Home menu, press the **Down Arrow** button and scroll to **Bias** and press **Enter**.
2. Press the **Up or Down Arrow** button to select either Moisture or Test Weight.
3. Press the **Up or Down Arrow** to increase/decrease the bias percentage.
4. Press the **Enter** button to save the changed setting or the **On/Off/Home** button to escape and retain the previous setting.

Figure 17

Modifying Moisture or Test Weight Bias

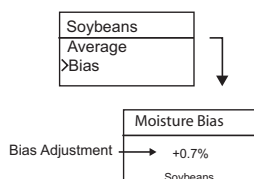

OPERATOR'S MANUAL



HISTORY

The History menu displays the last 10 test grain result readings from the unit regardless of the products selected.

Figure 18

History

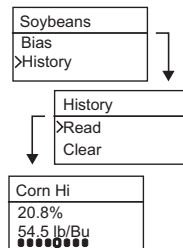

OPERATOR'S MANUAL



GRAIN CALIBRATIONS

Grain calibration values are typically updated on an annual basis. North American grain calibrations can be downloaded from the DICKEY-john website by installing a PC application software that can download calibrations to the mini GAC.

Visit www.dickey-john.com at the mini GAC product page to download U.S. grain calibrations and PC application software.

Grain calibration values vary based on regions. Non-North American calibrations should be obtained from a local distributor.

OPERATOR'S MANUAL



OPERATOR'S MANUAL



ACCURACY

Various factors can result in inaccurate grain readings. The following techniques provide possible solutions to ensure the most accurate readings.

CONDENSING SAMPLES (CORN DRYING)

When testing wet grain, moisture condensation can cling and build up on the cell causing inconsistent and inaccurate readings.

In between every measurement, use a soft cloth to wipe out the cell using extreme care not to damage the thermistor at the bottom of the cell.

Figure 19

Thermistor Position in Cell

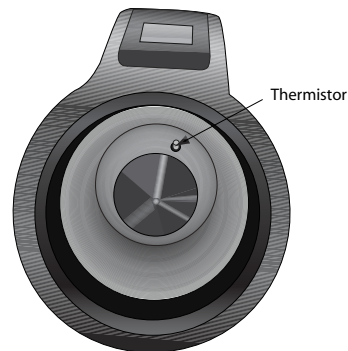

HIGH MOISTURE GRAINS

High moisture grains can get stuck when pouring into the cell.

NOTE: The mini GAC Loader hole size is designed to meet the US Federal Standard Quart Kettle Test Weight method.

To release grain:

1. Jiggle the slider back and forth to loosen the grain.
2. Poke the grain with a small object, such as a pencil to release grain into the cell.

OPERATOR'S MANUAL



3. Directly pour the grain into the cell using the fill cup, not using the loading base/slider. When using this technique, try to pour the grain in dead center.
4. Pour the grain smoothly and complete the pour in approximately 5 seconds.

IMPROVING GRAIN TEST RESULTS

For accurate test results, place the mini GAC on a level surface. Use the loader/striker and take a minimum of 3 separate test readings. Use the average of the results for greatest accuracy. The difference between the grain temperature and analyzer should not exceed 36 degrees F (20 degrees C).

OPERATOR'S MANUAL



ERROR CODES

Error codes display when an abnormal event occurs. An error can be acknowledged by pressing the **Enter** button to return to normal operation.



LOW BATTERY VOLTAGE

Low Battery voltage displays when the battery voltage falls below 6.4V but is above 6.2V. When the battery voltage is low, the unit is still capable of making accurate measurements, but the battery should be replaced soon. Several warnings will display before the dead battery screen appears.

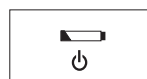

DEAD BATTERY WARNING

Displays when the battery voltage falls below 6.2V. When the battery voltage is lower than 6.2V, the unit is not capable of making accurate measurements and the unit will no longer operate other than to power off.

ERROR 10

Probable Cause

The measured temperature is below minimum. The unit temperature is measured on start up and displays if the temperature is below 32 degrees F (0 degrees C).

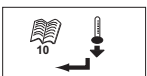

Corrective Action

1. Pressing the **Enter** button causes the unit temperature measurement to repeat and operation will proceed if the cell temperature is above the minimum, otherwise Error 10 displays again.
2. If unit temperature is still below the minimum, wait to test until the temperature is greater than 32 degrees F (0 degrees C).

OPERATOR'S MANUAL



ERROR 12

Probable Cause

The measured temperature is above maximum. The cell temperature is measured on startup and Error 12 displays if the temperature is above +158 degrees F (70 degrees C).

Corrective Action

1. Pressing the **Enter** button causes the cell temperature measurement to repeat and operation will proceed if the cell temperature is below the maximum, otherwise Error 12 displays again.
2. If cell temperature is still above maximum, wait to test until unit temperature is less than 158 degrees F (70 degrees C).



ERROR 20

Probable Cause

Error 20 displays if the measured product moisture is below the lower limit of the production calibration.

Corrective Action

1. Press **Enter** to show measured results.

Pressing the **On/Off/Home** button returns operation to the Home menu.



ERROR 22

Probable Cause

Error 22 displays if the measured product moisture is above the upper limit of the product calibration.

Corrective Action

1. Press **Enter** to show measured results.

Pressing the **On/Off/Home** button returns operation to the Home menu.

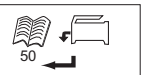

ERROR 50

Probable Cause

Error 50 displays if the weight measurement during the Empty Cell test indicates a mass that exceeds 35 grams.

OPERATOR'S MANUAL



Corrective Action

1. Ensure the Loader cup is removed during the empty cell test.
2. Make sure cell is empty prior to empty cell test.

Pressing the **Enter** button returns operation to the Home menu.

ERROR 56

Probable Cause

Error 56 displays when the measured average tilt angle exceeds 10 degrees after an Empty Cell and/or a Full Cell test phase.

Corrective Action

1. Hold mini GAC level while performing test or
2. Place on level surface to perform test.

Pressing the **Enter** button returns operation to the Home menu.

OPERATOR'S MANUAL



OPERATOR'S MANUAL



DIAGNOSTICS

INFORMATION

The Information menu provides system details that could be helpful to technicians during service calls.

Details included on the Information menu:

- Software version
- Unit name
- Technical Service phone number
- Battery voltage
- Part Number

Figure 20

Information Menu

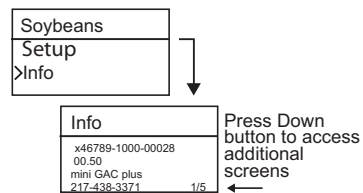

For troubleshooting assistance, please contact DICKEY-john technical support at 1-800-637-3302 or local distributor.

OPERATOR'S MANUAL



Dealers have the responsibility of calling to the attention of their customers the following warranty prior to acceptance of an order from their customer for any DICKEY-john product.

DICKEY-john® WARRANTY

DICKEY-john warrants to the original purchaser for use that, if any part of the product proves to be defective in material or workmanship within one year from date of original installation, and is returned to DICKEY-john within 30 days after such defect is discovered, DICKEY-john will (at our option) either replace or repair said part. This warranty does not apply to damage resulting from misuse, neglect, accident, or improper installation or maintenance. Said part will not be considered defective if it substantially fulfills the performance expectations. THE FOREGOING WARRANTY IS EXCLUSIVE AND IN LIEU OF ALL OTHER WARRANTIES OF MERCHANTABILITY, FITNESS FOR PURPOSE, AND OF ANY OTHER TYPE, WHETHER EXPRESS OR IMPLIED. DICKEY-john neither assumes nor authorizes anyone to assume for it any other obligation or liability in connection with said part and will not be liable for consequential damages. Purchaser accepts these terms and warranty limitations unless the product is returned within fifteen days for full refund of purchase price.

For DICKEY-john Service Department, call 1-800-637-3302 in either the U.S.A. or Canada



Headquarters:

5200 Dickey-john Road, Auburn, IL 62615
TEL: 217-438-3371, FAX: 217-438-6012, WEB: www.dickey-john.com

Europe:

DICKEY-john Europe S.A., 165, boulevard de Valmy, 92700 –
Columbes – France www.dickey-john.eu
TEL: 33 (0) 1 41 19 21 80, FAX: 33 (0) 1 47 86 00 07

Copyright 2007 DICKEY-john Corporation
Specifications subject to change without notice.