

SMARTDRIVE VF1000 · L Series

EN

Frequency Inverters 1.5 to 22kW

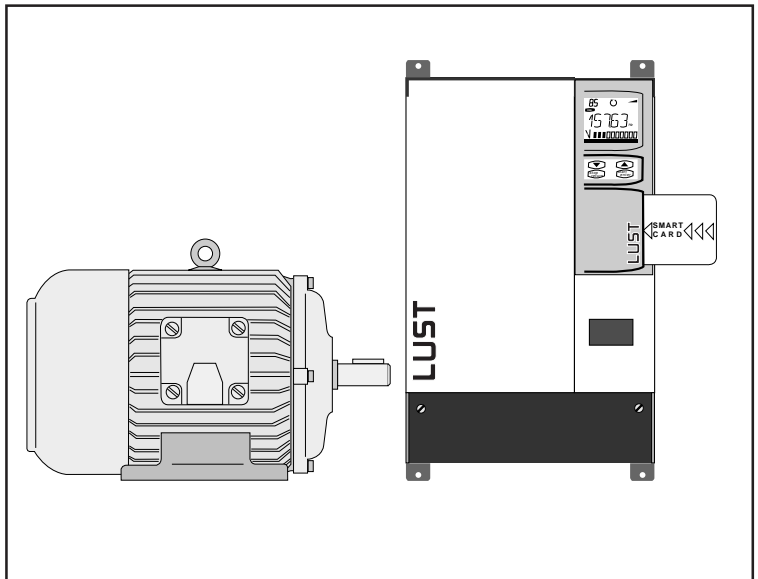

Instruction Manual
for static
Frequency Inverters

1 x 230 V - Version

VF1207L - 1.5 kW

VF1209L - 2.2 kW

3 x 400/460 V - Version

VF1404L - 1.5 kW

VF1406L - 2.2 kW

VF1408L - 3 kW

VF1410L - 4 kW

VF1414L - 5.5 kW

VF1418L - 7.5 kW

VF1432L - 11 kW

VF1432L - 15 kW

VF1445L - 22 kW

Valid from Software Version V 1.5

Id.No.: 0786.21B.1 - 00

Issue: June 1996

Dear Customer!

We should like to thank you for the trust that you have placed in us by purchasing the Lust SMARTDRIVE Frequency Inverter.

Installation and commissioning should be carried out by trained personnel. Please take the time to read the instructions carefully. If you follow all the instructions, you will save yourself much time and many questions at the commissioning stage.

Reading the instructions is essential for another reason too: incorrect use of the equipment can damage both the inverter and also other parts of the installation.

If after reading the instructions you still have questions, do please contact us.

Lust Antriebstechnik GmbH
Gewerbestr. 5-9
D-35633 Lahnau
Germany
Tel: +49 6441 966 - 0
Fax: +49 6441 966 - 137

A Information about the Instruction Manual

The information contained in this manual applies to all frequency inverters SMARTDRIVE VF 1000, Series L. Suffix L stands for "Large" (size of the enclosure).

This instruction manual contains 6 chapters listed under "Signpost to Success".

Chapter A provides information on design versions, safety information and CE acceptance procedure.

Chapters 1, 2 and 3 contain important information on commissioning. Chapters 4, 5 and 6 provide information on controlling the inverter with the use of the KEYPAD, and the device parameters.

A number of different versions with special functions are available to meet varying customer requirements for frequency inverters. Version information which differs from standard is noted in the option descriptions.

For ease of use the following symbols are used to identify warnings and importance advice:



⇒ Caution! Danger of death by electrocution.



⇒ Warning! It is essential that this instruction be followed.



⇒ Warning! Before opening the equipment, disconnect from the mains power supply and wait approximately 2 minutes for the DC link capacitors to discharge.



⇒ Prohibited! Incorrect operation may cause damage to the equipment.



⇒ Useful tip



⇒ Settings can be changed with the KeyPad.

Signposts to success

A	Information about the Instruction Manual	A-2
A.1	Safety instructions	A-4
A.2	Using the inverter for the intended purpose	A-5
A.3	Design and accessories	A-6
A.4	Inverter manufacturer's declaration	A-8
A.5	VF1000 Series L with CE tap	A-12
A.6	Information on installation in accordance with suppression regulations (EMC)	A-16
1	Technical Specifications	1-1
1.1	Design and Layout	1-1
1.2	Data Table	1-2
1.3	Dimensions	1-5
1.4	Installation	1-6
2	Electrical Connections	2-1
2.1	Connections	2-1
2.2	Radio Interference Suppression	2-3
2.3	Power Connections	2-4
2.3.1	Mains Power Supply Connections	2-4
2.3.2	Braking Chopper	2-5
2.3.3	Motor Connection	2-6
2.4	Control Connections	2-7
2.4.1	Specification	2-7
2.4.2	Function of FSINA Reference Value Input	2-8
2.4.3	Control Functions using STR/STL	2-10
2.4.4	Control Functions via S1IND/S2IND	2-11
2.4.5	Signal Outputs	2-13
2.4.6	LUSTBus Connection	2-15
2.4.7	INTERBUS-S Connection	2-16
2.4.8	CAN-Bus Connection	2-18
3	Operating and Fault Diagnosis	3-1
3.1	Operating Display	3-1
3.2	Error Messages	3-1
3.3	Warning Messages	3-2
3.4	Motor/inverter Overload Protection (I * t Monitoring)	3-3

4	Using the KEYPAD KP100	4-1
4.1	Layout	4-1
4.2	General	4-2
4.2.1	Menu Options	4-2
4.2.2	Key Functions	4-2
4.2.3	LCD Display	4-3
4.3	Menu Structure	4-4
4.3.1	Overview	4-4
4.3.2	MOP - Function	4-6
5	Parameter List	5-1
5.1	Operating Level 1	5-1
5.2	Operating Level 2	5-2
5.3	Inverter-Type-Dependent Parameters	5-4
6	Parameter Description	6-1
6.1	Reference Value Input	6-1
6.2	Actual Values	6-5
6.3	Frequencies	6-7
6.4	Ramps	6-8
6.5	Characteristics	6-10
6.6	Special Functions	6-11
6.7	Signal Outputs	6-17
6.8	Program Functions	6-18

A.1 Safety instructions



Running inverters may have live, unprotected, moving or rotating parts and hot surfaces, depending on their types of enclosure. Therefore, inverters are potentially hazardous to life.

To avoid serious injury or major damage to equipment, only suitably qualified personnel familiar with electric drives may work on this equipment. The suitable personnel are those acquainted with installation, assembly, commissioning and operation of inverters and appropriately qualified in their trade. They must read these instructions carefully before installation and commissioning and follow the safety instructions in detail.

(IEC364, CENELEC HD 384 or DIN VDE 0100 specifications and EIC Report 664 or VDE 0110 specification and the appropriate national accident prevention regulations or the VBG4 regulations must be observed in this connection.)

Repairs to the unit must be carried out by the manufacturer or service workshops authorized by him. Injury or damage to property may result if the unit is interfered with or opened by an unauthorized person.

A.2 Using the inverter for the intended purpose

Inverters are designed for use in electrical systems or machinery.

An inverter installed in a machine must not be commissioned (that is started for the first time) until compliance with the stipulations of the EC guideline specification 89.392/EEC (machine design guideline specification) is confirmed; the requirements contained in EN 60204 must be observed.

The low voltage guideline specification 73/23/EEC is applied to inverters in conjunction with the homologated prEN50178/DIN VDE 0160 series standards in conjunction with EN 604391/DIN VDE 0660 Part 500 and EN 60146/DIN CDE 0558. Technical data and information on power connections will be found on the data plate and in written documentation and must be strictly followed.



Inverters must be protected against excessive mechanical stresses. It is particularly important to ensure that no components become distorted and/or that no insulation gaps are disturbed in transit. Inverters contain components sensitive to electrostatic conditions and can be easily damaged by careless handling. Electrical components must not be allowed to suffer mechanical or any other damage.

The current national health and safety regulations (such as VBG 4) must be observed when working on live inverters.



Electrical installation must be carried out in accordance with the relevant specifications (e.g. cable cross-section, fuses, grounding lead connection). Further relevant information will be found in the documentation.

Electronic equipment is not inherently fail-safe. The user therefore accepts responsibility for ensuring that the drive reverts to a safe condition if the equipment fails.

If the inverter is used in a special environment (e.g. in an explosive atmosphere), the standards and specifications applying to the specific application (e.g. EN50014 and EN 50018) must be strictly observed.



A.3 Design and accessories

General information

The standard version of the VF1000L carries this type designation without additions. Variations from this standard version are marked by suffixes added to the basic type code.

Each suffix has a specific meaning; see inverter versions. Special inverters which are not listed are also marked by the appropriate version suffixes which are not shown here.

Ordering of type designation code

Standard A

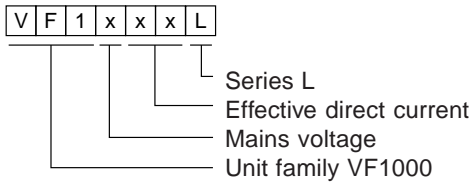

Ordering of type designation code

Standard B

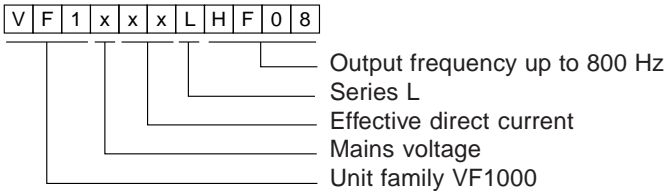

Type key for non-standard versions

Only one terminal is specified for each version; it can only be occupied once. The number and sequence of the code suffix is free, the codes must be separated by a comma.

Example

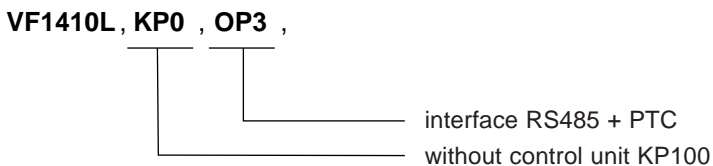

Versions of inverter VF1000L

Out of the versions shown, only one type can be ordered for each location (e.g. external options = 1, internal options = 3).

Selection of versions available:

Location	Description	Type Code
1	Without KEYPAD KP100	KP0
3	Digital frequency reference value setting	OP1
3	Thermistor evaluation (PTC)	OP2
3	Interface RS485 + PTC	OP3
3	OP1 + OP3 + external addressing	OP4
3	3rd control input S3IND	OP5
3	Analog ref. value setting with +/-10V	OP6
3	OP5 + OP6	OP7
3	Frequency reference value for optical cable	OP10
3	INTERBUS-S interface	C1
3	CAN-Bus interface	C2

Accessories for inverter VF1000L

Accessories can be fitted retrospectively by the customer himself because the inverter does not need to be opened to fit them.

	Description	Ordering code
General accessories	SMARTCARD, without data Control unit, incl. chip card reader	ZSC KP100
Mains chokes	for VF1207L/09L for VF1404L/06L for VF1408L, VF1410L for VF1414L for VF1418L for VF1424L for VF1432L for VF1445L	END20 DND6 DND10 DND14 DND18 DND24 DND32 DND45
Sup-pressors	for VF1207L for VF1209L for VF1404L/06L/08L for VF1410L/14L for VF1418L for VF1424L/32L for VF1445L	FN350-12-29 FN350-20-29 FN351-8-29 FN351-16-29 FN351-25-33 FN351-36-33 FN351-50-33

A.4 Inverter manufacturer's declaration

D - 35633 Lahnau (Germany)

Tel.: 06441 / 966-0

Product Description: Frequency Inverter

Type: VF1404L; VF1406L; VF1408L
VF1410L; VF1414L; VF1418L

The product described is intended exclusively to be installed in another installation in the sense of the Machinery Directive.
Commissioning is prohibited until such time as conformity of the end product with Directive 89/392/EEC is established.

The standards relevant to Directive 89/338/EEC (EMC) which have been applied to the product described are listed in the annex.
In order to comply with EMC legislation the installation instructions and safety documentation must be observed.

Manufacturer: Company
Lust Antriebstechnik GmbH

Place, Date: Lahnau, 29.11.95

Legally binding signature: 
K.H. Lust Managing Director

The annex forms part of this declaration.
This declaration does not imply any assured characteristics.
The installation directions and safety instructions in the product documentation must be observed.

MDEMC_L1.DOC 29.11.95

Harmonized European Standards to EMC:

Title	Reference Numbe
Generic Standard: Interference emission Part 1: Domestic	EN 50081-1
Generic Standard: Interference immunity Part 2: Industrial	EN 50082-2

National Standards:

Reference Number	Date of Issue	Reference Numbe
.....
.....
.....
.....
.....

IEC - Standards :

Reference Number	Date of Issue	Reference Numbe
.....
.....
.....
.....
.....

Address: Gewerbestraße 3-5
D - 35633 Lahnau (Germany)
Tel.: 06441 / 966-0

Product Description: Frequency Inverter
Type: VF1424L; VF1432L; VF1445L

The product described is intended exclusively to be installed in another installation in the sense of the Machinery Directive. Commissioning is prohibited until such time as conformity of the end product described is established.

The standards relevant to Directive 89/338/EEC (EMC) which have to be observed for the product described are listed in the annex. In order to comply with EMC legislation the installation instructions and safety documentation must be observed.

Manufacturer: Company
Lust Antriebstechnik GmbH

Place, Date: Lahnau, 29.11.95

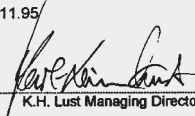
Legally binding signature: 
K.H. Lust Managing Director

The annex forms part of this declaration.
This declaration does not imply any assured characteristics.
The installation directions and safety instructions in the product documentation must be observed.

MDEMC_L2.DOC 29.11.95

Harmonized European Standards to EMC:

Title	Reference Number
Generic Standard: Interference emission Part 1: Industrial	EN 50081-2
Generic Standard: Interference immunity Part 2: Industrial	EN 50082-2

National Standards:

Reference Number	Date of Issue	Reference Number
.....
.....
.....
.....
.....

IEC - Standards :

Reference Number	Date of Issue	Reference Number
.....
.....
.....
.....
.....

A.5 VF1000 Series L with CE tap

Copie of the CE test report for the inverters VF1404L ... VF1414L

Object

Hersteller
Manufacturer

Fa. Lust Antriebstechnik
GmbH
Gewerbestr. 5-9
D-35631 Lahnau

Typ
Item

VF 1404V, VF 1406V
VF 1408V, VF 1410
VF 1414

Auftraggeber
Customer

Fa. Lust
Antriebstechnik GmbH

Auftragsnummer
Order No.

1 HID 3525

Anzahl der Seiten des
Prüfberichts
Report volume

133

Datum der Anlieferung
Date of delivery

24.08.1994

Datum der Prüfung
Date of test

24.08-02.09.1994

Dieser Prüfbericht darf nur vollständig und unverändert weitergegeben werden. Ausz
Prüfzentrum für Umweltsimulation und Typprüfungen (QST). Prüfberichte ohne Unters
Gültigkeit. Die Prüfergebnisse beziehen sich ausschließlich auf den oben genannte
This test report may only be reproduced in full length. Extracts publishing r
laboratory. Test result without signature and seal are not valid. The test results

Stempel



Leiter der Prüfstelle

G. Hill

(G. Hill)

CARL SCHENCK AG · Landwehrstraße 55

Die in der nachfolgenden Tabelle aufgeführten Konformitätstests gemäß dem EMV-Gesetz, Betriebsmittel die für eine Verwendung im t sowie im rauen Industriebereich vorgesehen. Die Bewertung der Störfestigkeitsprüfungen Bewertungskriterien der prEN 50082-2/01.93

Tabelle Prüfergebnisse:

Titel	EG-Richtl. Europäische Norm
Niederspannungsrichtlinie (SEB=Sicherheit elektrischer Betriebsmittel)	73/23/EWG
EMV-Richtlinie bzw. EMVG Fachgrundnorm Störfestigkeit Teil 2: Industriebereich	89/336/EWG prEN 50 082-2
EMV-Richtlinie bzw. EMVG Fachgrundnorm Störaussendung Teil 1: Wohngebiete	89/336/EWG EN 50 081-1

Allgemeines zu den Prüfungen:

Der Frequenzumwandler 1404V/06V/08V/10/14 i reiche (Wohngebiet und Industriebereich) ein nach der jeweils schärferen Anforderung c Störfestigkeit ist dies die prEN 50 082-2 (I für die Störaussendung die EN 50 081-1 (Woh

Ausgabe	Name	Datum
31.10.1994	QST/Hielscher	734-24.T

Copie of the CE test report for the inverters VF1418L ... VF1445L

Object

Hersteller
Manufacturer

Fa. Lust Antriebstechnik
GmbH
Gewerbestr. 5-9
D-35631 Lahnau

Typ
Item

VF 1418, VF 1424
VF 1432, VF 1445

Auftraggeber
Customer

Fa. Lust
Antriebstechnik GmbH

Auftragsnummer
Order No.

1 HID 3525

Anzahl der Seiten des
Prüfberichts
Report volume

152

Datum der Anlieferung
Date of delivery

24.08.1994

Datum der Prüfung
Date of test

24.08-02.09.1994

Dieser Prüfbericht darf nur vollständig und unverändert weitergegeben werden. Auszi
Prüfzentrums für Umweltsimulation und Typprüfungen (QST). Prüfberichte ohne Unters
Gültigkeit. Die Prüfergebnisse beziehen sich ausschließlich auf den oben genannten
This test report may only be reproduced in full length. Extracts publishing in
laboratory. Test result without signature and seal are not valid. The test results :

Stempel



Leiter der Prüfstelle

B. Pötschke

(K. Pötschke)

(8)

CARL SCHENCK AG · Landwehrstraße 55

konformitätsgeprüft gemäß dem EMV-Gesetz
 Betriebsmittel die für eine Verwendung im
 sowie im rauen Industriebereich vorgesehen.
 Die Bewertung der Störfestigkeitsprüfungen:
 Bewertungskriterien der prEN 50082-2/01.93

Tabelle Prüfergebnisse:

Titel	EG-Richtf. Europäische Norm
Niederspannungsrichtlinie (SEB - Sicherheit elektrischer Betriebsmittel)	73/23/EWG
EMV-Richtlinie bzw. EMVG Fachgrundnorm Störfestigkeit Teil 2: Industriebereich	89/336/EWG prEN 50 082-2
EMV-Richtlinie bzw. EMVG Fachgrundnorm Störaussendung Teil 1: Wohngebiete	89/336/EWG EN 50 081-1

Allgemeines zu den Prüfungen:

¹⁾Der Frequenzumrichter VF 1418 kann
 (Wohngebiet und Industriebereich) eing.
 Frequenzumrichter VF 1424, VF 1432 und
 die Anforderungen der EMA im Wohngebiet
 nur im Industriebereich einzusetzen.
 jeweils schärferen Anforderung geprüft
 stigkeit ist dies die prEN 50 082-2 (I
 für die Störaussendung die EN 50 081-1

Ausgabe	Name	Datum
11.11.1994	QST/Hielscher	736-24.1

A.6 Information on installation in accordance with suppression regulations (EMC)

VF1000L series frequency inverters fulfil the low voltage guideline specifications and can be adapted to comply with stringent specifications allowing them to be used within dwelling areas (except VF1424L up to 45L). Their technical acceptance/approval tests were carried out under laboratory conditions in the approved Schenk testing workshop and the results cannot be guaranteed to apply to site conditions in a machine or plant.

The following illustration shows installation details providing optimum results.

EMC will be achieved by providing the following measures:

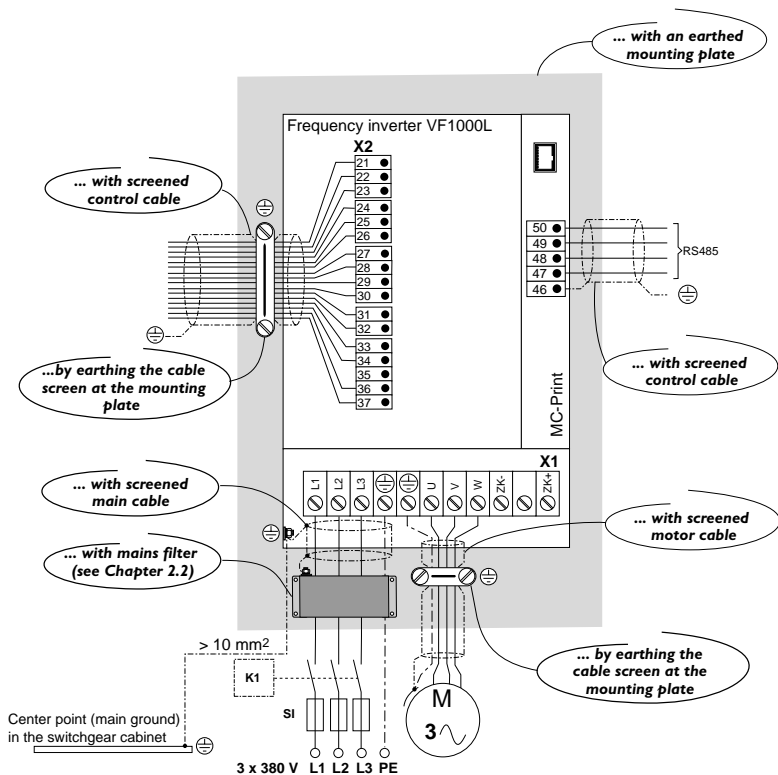

Important:

See Chapter 2.1 and 2.2 for further information



1 Technical Specifications

1.1 Design and Layout

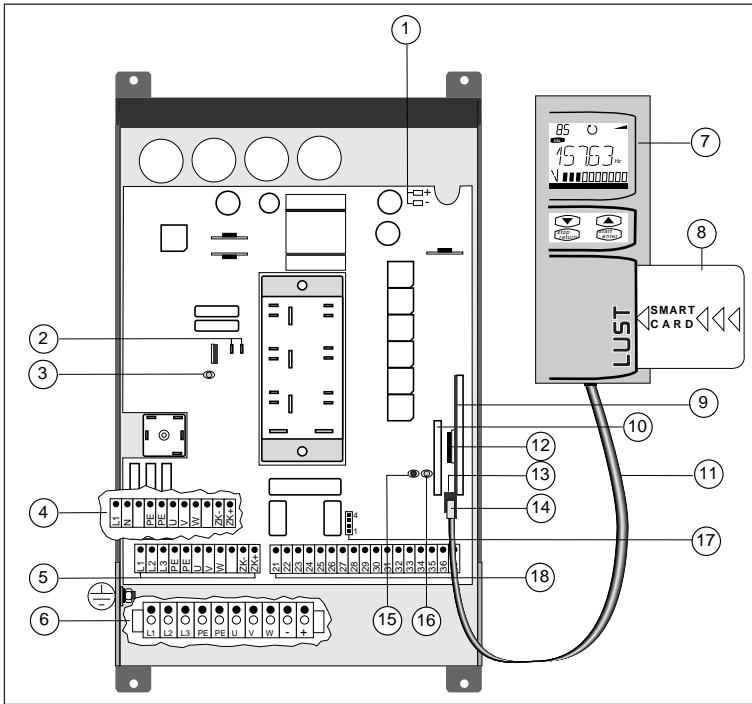

Key

- | | |
|--|--|
| 1 DC fan connection | 10 Socket for optional card |
| 2 Connection for additional breking resistor (external) | 11 KEYPAD connector cable |
| 3 LED (yellow) indicates“breking chopper active | 12 Software version label |
| 4 Terminal strip X1 for power connections VF1207L, VF1209L | 13 Terminal strip X42 for interface RS485 |
| 5 Terminal strip X1 for power connections VF1404L ...VF1414L | 14 Socket X41 for KEYPAD |
| 6 Terminal strip X0 for power connections VF1406L ...VF1415L | 15 LED H2 (green) operating indicator |
| 7 KEYPAD control unit | 16 LED H1 (red) error indicator |
| 8 SMARTCARD chip card | 17 Jumper strip X11, see reference value setting |
| 9 Socket for optional card | 18 Terminal strip X2 control connections |

1.2 Data Table

	Code	Unit	VF1207L	VF1209L	VF1404L	VF1406L	VF1408L
Output motor side							
Recom. rating with 4 pole standard motor	P	kW	1,5	2,2	1,5	2,2	3
Unit power	S	kVA	2,4	3,7	2,4	3,8	4,9
Phase current (100% I _N)	I	A	16,2	19,6	23,5	25,6	27,2
Continuous load	-	%	110				
Overload factor (60 sec.)	-	%	150				
Overload current	I _{MAX}	A	9,3	14,4	5,3	8,4	10,8
Voltage	U	V	3 x 0...230		3 x 0...400/460		
Rotating field frequency	f	Hz	0...400				
Frequency resolution	f	%	0,1 of FMAX (0,05 Hz min.)				
Load type	-	-	ohmic/ inductive				
Short circuit proof	-	-	at terminals				
Leakage to earth	-	-	at every power on				
Input mains side							
Mains voltage	U	V	1 x 230V +15/-20%		3 x 460 +10/-26%		
Mains frequency	f	Hz	50/60 +/- 10%				
Power factor	A	mm ²	2,5				
Recom. input fuse ³	I	AT	1 x 16	1 x 16	3 x 16	3 x 16	3 x 16
Mains voltage inbalance	ΔU	%	-		3 max.		
General							
Operation	-	-	4 quadrants				
Peak break power	P _{BRSP}	kW	1,6 max.		6 max.		
Power loss	P _V	W	130	140	100	100	120
Efficiency (P _N)	h	%	95	95	95	95	96
Ambient conditions							
Cooling air temperature	T	°C	0 ... 40				
Power reduction / ambient temperature	-	-	2,5 %/°C in the range 40°C...50°C				
Max. installation altitude a.s.l.	-	m	1000 m (with 5 % loss up to max. 2000 m)				
Relative humidity	-	%	15 ... 85 non-condensing				
Vibration (IEC 68-2-6)	-	-	2 g				
Weight/dimensions							
Dimensions (HxWxD)	-	mm	210 x 350 x 180				
Weight (excl. packing)	-	kg	approx. 6,9 kg				
Protection	-	-	IP20, VBG4, NEMA 1				
Type of installation	-	-	vertical wall mounting				

¹ With 230V mains supply.

² With 400V mains supply (with 460V mains supply, reduce current by -15%).

³ Note also the data of the local mains if mains fuse protection is provided.

	Code	Unit	VF1410L	VF1414L	VF1418L	VF1424L	VF1432L	VF1445L
Output motor side								
Recom. rating with 4 pole standard motor	P	kW	4	5,5	7,5	11	15	22
Unit power	S	kVA	² 6,1	² 8,6	² 11,4	² 15,9	² 20,7	² 30,1
Phase current (100% I _N)	I	A	² 8,9	² 12,5	² 16,5	² 23	² 30	² 43
Continuous load	-	%	110					
Overload factor (60 sec.)	-	%	150					
Overload current	I _{MAX}	A	13,5	18,8	25	34,5	45	52
Voltage	U	V	3 x 0...400/460					
Rotating field frequency	f	Hz	0...400					
Frequency resolution	f	%	0,1 of FMAX (0,05 Hz min.)					
Load type	-	-	ohmic/ inductive					
Short circuit proof	-	-	at terminals					
Leakage to earth	-	-	at every power on					
Input mains side								
Mains voltage	U	V	3 x 460 +10/-26%					
Mains frequency	f	Hz	50/60 +/- 10%					
Power factor	A	mm ²	2,5			10		
Recom. input fuse ³	I	AT	3 x 16	3 x 20	3 x 25	3 x 35	3 x 50	3 x 63
Mains voltage imbalance	ΔU	%	3 max.					
General								
Operation	-	-	4 quadrants					
Peak break power	P _{Brsp}	kW	6 max.					
Power loss	P _V	W	160	180	225	330	400	500
Efficiency (P _N)	h	%	96	97	>97	>97	>97	>97
Ambient conditions								
Cooling air temperature	T	°C	0 ... 40					
Power reduction / ambient temperature	-	-	2,5 %/°C in the range 40°C...50°C					
Max. installation altitude	-	m	1000 m (with 5 % loss up to max. 2000 m)					
Relative humidity	-	%	15 ... 85 non-condensing					
Vibration (IEC 68-2-6)	-	-	2 g					
Weight/dimensions								
Dimensions (HxWxD)	-	mm	210 x 350 x 180			210 x 350 x 272		
Weight (excl. packing)	-	kg	approx. .6,9 kg			10,1 kg	10,7 kg	
Protection	-	-	IP20, VBG4, NEMA 1					
Type of installation	-	-	vertical wall mounting					

FMAX = 800 Hz 74PWM = 2	Code	Unit	VF1408L HF08	VF1410L HF08	VF1414L HF08	VF1418L HF08	VF1424L HF08
Output, motor end							
Unit power	S	kVA	4,9	6,1	8,6	11,4	15,9
Phase current ¹⁾ (100%)	I _N	A	7,2	8,9	12,5	16,5	23
Phase current at 460 V			6,2	7,8	10,8	14,5	20
Overload current (60 sec.)	1,5xI _N	A	10,8	13,5	18,8	25	34,5
Overload current at 460 V			9,3	11,7	16,2	21,8	30
Rotating field frequency	f	Hz	0 ... 800				
FMAX = 1600 Hz 74PWM = 3	Code	Unit	VF1408L HF08	VF1410L HF08	VF1414L HF08	VF1418L HF08	VF1424L HF08
Output, motor end							
Unit power	S	kVA	3,8	4,9	6,1	8,6	11,4
Phase current ¹⁾ (100%)	I _N	A	5,6	7,2	8,9	12,5	16,5
Phase current at 460 V			4,8	6,2	7,8	10,8	14,4
Overload current (60 sec.)	1,5xI _N	A	8,4	10,8	13,5	18,8	25
Overload current at 460 V			7,2	9,3	11,7	16,2	21,6
Rotating field frequency	f	Hz	0 ... 1600				
Miscellaneous							
Power loss (inverter)	P _V	W	140	180	210	290	400
Mechanical data							
Weight	M	kg	approx. 6,9		10,1	10,7	
Dimensions	A	mm	210x350x180		210x350x272		

Standard units type HF08 can be set to an output frequency up to FMAX 1600 Hz. Note also the end stage cycle frequency (74PWM). If the cycle frequency is to be set higher, it will be necessary to reduce the output power (see table).

1.3 Dimensions

Equipment group VF1418L ... VF1445L

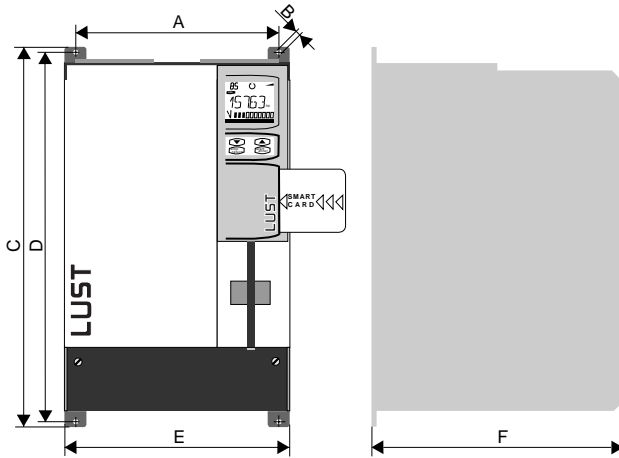

Equipment group VF1207L ... VF1414L

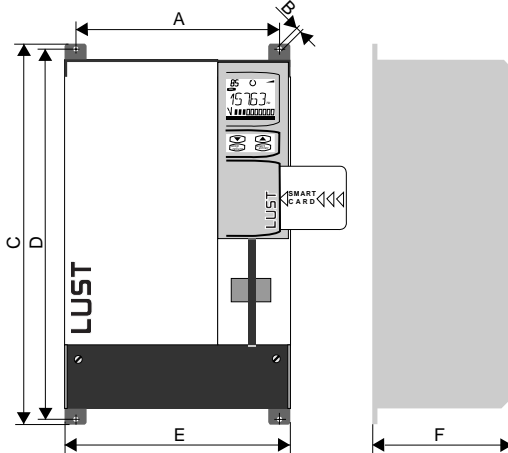

Dimensions

Equipment	A	B	C	D	E	F
VF1207L...VF1414L	175	5,8 \emptyset	350	340	210	180
VF1418L...VF1445L	175	5,8 \emptyset	350	340	210	272

All dimensions in mm

1.4 Installation

General:

The location for installation must be free from conducting or corrosive materials and also free from humidity. Frequency inverters are normally housed in cabinets with external air throughflow. They are attached to a mounting board with four M5 screws.

It is essential that the minimum distances above and below the unit are observed to avoid heat buildup. The air openings on the top surface must not be covered or closed under any circumstances.

Units may be mounted directly adjacent to each other horizontally, with no limit on number.



Warning:

Take care to ensure that no foreign bodies, such as metal swarf or screws, drop into the equipment, as it may be damaged beyond repair.

Installation clearances:

The size of the control cabinet depends partly on the power loss of the inverter (see performance table). To avoid heat buildup in the cabinet it is essential that appropriate minimum clearances are observed. Correct installation will ensure a long and safe service life.

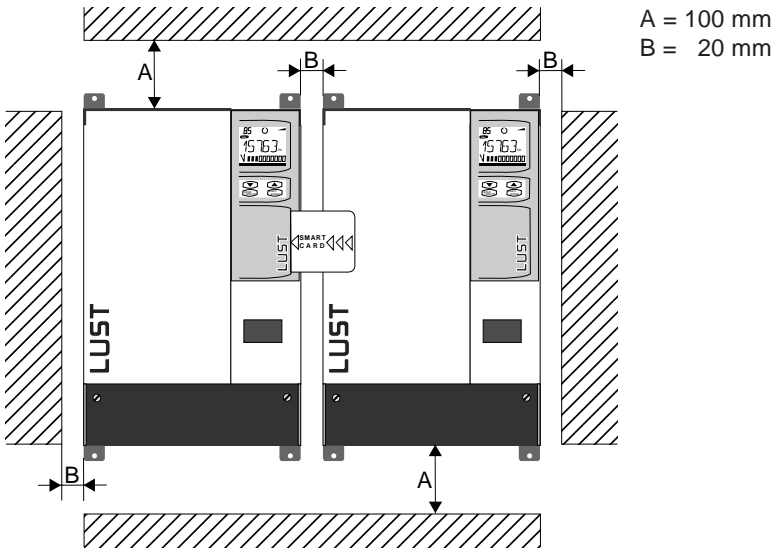

2 Electrical Connections

2.1 Connections

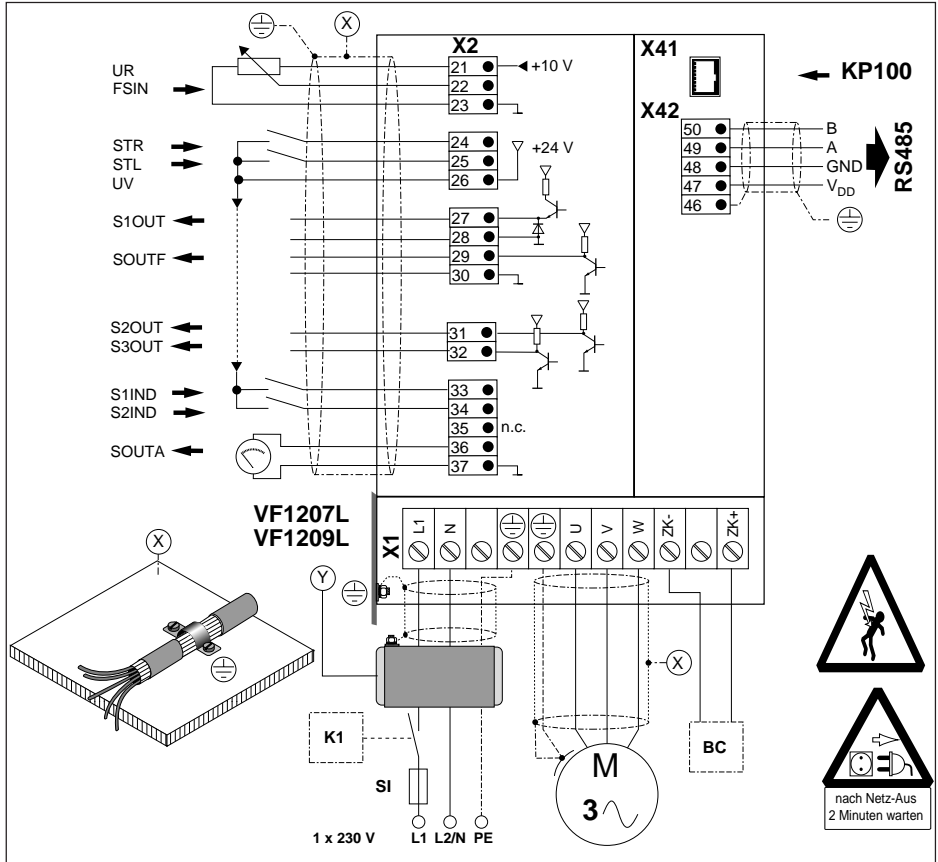

Terminal connections

X2 Code	Explanation	X2 Code	Explanation
21 UR	10 V ref. volt. for ref. value potentiometer	29 FOUTF	digital frequency output
22 FSIN	frequency reference value input	31 S2OUT	prog. output LOW active
23,28,30	Ground reference point, control connection	32 S3OUT	prog. output LOW active
24 STR	start clockwise input	33 S1IND	prog. input digital
25 STL	start counterclockwise input	34 S2IND	prog. input digital
26 UV	supply voltage 24 V DC	35 n.c.	not allocated
27 S1OUT	prog. output HIGH active	36 SOUTA	prog. output analog

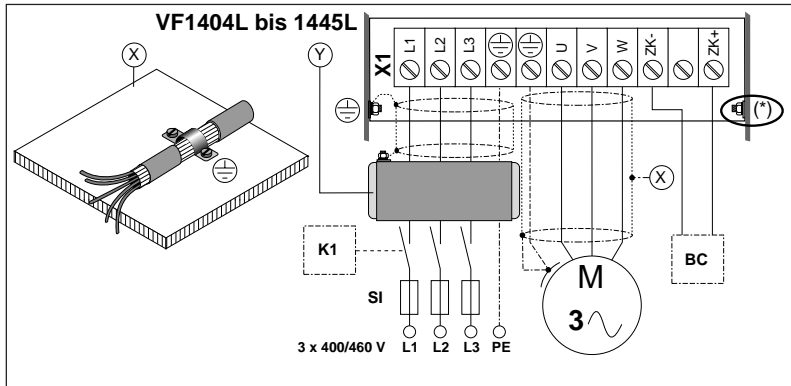

* In the case of units VF1418L ... 1445L the earthing pin \ominus is located in the r.h. panel.



Note:

The KeyPAD control unit plugs into the 8-pin KP100 socket (see also layout).

The serial interface RS485 connects through the terminal strip X2/46...50. The terminal strip X1 is mounted directly on the mother board. It is used in VF1404L...VF1414L and VF1207L/ 09L.

The X0 terminal strip is a terminal block which is mounted on the heat sink. It is used in VF1418L ...VF1445L.

Warning:

The following effective voltages from the mains must not be exceeded for all units described in this Instruction Manual:

VF1207L/1209L	L1	->	L2/N	230VAC
	L1	->	\ominus	270VAC
	L2/N	->	\ominus	270VAC
VF1404L bis	L1	->	L2 ->	460VAC
VF1445L	L1/L2/L3	->	\ominus	270VAC

2.2 Radio Interference Suppression

All Series L SMARTCARD frequency inverters fulfil the requirements in respect of resistance to electromagnetic interference in industrial areas as per EC Guideline Specifications/European Standard 89/336/EEC, prEN 50 062-1 (see also CE Test Certificate in Chapter A).

The certified EMC test (resistance to EMC interference) for inverters was carried out in laboratory conditions as per prEN 50082-2/01.93.

It is essential to observe the following instructions with regard to compliance with the EMC law relating to inverters installed in machinery:



- ⇒ Motor cable, mains cable and control cables must be screened and routed separately.
- ⇒ The inverter unit must be bolted to a well earthed mounting plate. A shakeproof washer (Z) must be placed under the head of each of the fixing bolts to ensure reliable contact at the mounting plate.
- ⇒ The mains cable screen must be laced to the earthing bolt at the inverter end over the shortest possible piece of wire (length <2.5 cm, see layout of connections).
- ⇒ Attach the motor and control cable screens on the surface of the conductive mounting plate (remove paint, as necessary) as close to the inverter terminals as possible. Use a conductive cable for this purpose, as shown in the drawing (X).
- ⇒ The interface connection screen, can be carried to the X42/46 terminal. The connecting wire must be as short as possible here as well (length: <2.5 cm).
- ⇒ The motor terminal box must be HF-radiation-proof. It must therefore be manufactured from metal or metallized plastic.
- ⇒ Cable bushing for the motor cable at the terminal box must be of the conductive threaded union type with laced screening.

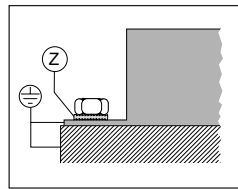

A mains filter must be installed as in the drawing (Y), to prevent line-related asymmetrical interference voltages.

FN 350-12-29	for VF1207L	FN 351-25-33	for VF1418L
FN 350-20-29	for VF1209L	FN 351-36-33	for VF1424/32L
FN 351-8 -29	for VF1404/06/08L	FN 351-50-33	for VF1445L
FN 351-16-29	for VF1410L/14L		

2.3 Power Connections

2.3.1 Mains Power Supply Connections

General:

Inverters must be connected to the mains power supply in accordance with the VDE regulations such that they can be isolated from the mains at any time with appropriate means of isolation such as a master switch.



Warning:

Never connect inverters to the mains, start or acknowledge an error while a connected, permanently excited synchronous motor is still running.



Note:

When mains power is first supplied to the inverter it first charges the internal intermediate circuit. That means that the inverter is only ready to operate after a certain switch-on delay. Mains switch-on can therefore only be repeated at reasonably long intervals (**60 sec.**). Pulsing the mains contactor is not permissible.



Warning:

Because of the high leakage current (> 3.5 mA) in general the use of FI protective switches alone is not permitted. A protective ground is therefore mandatory.

Mains fuses must be designed to suit the current load of the connecting cable to DIN 57100 (see recommendations in the Power Table).

VF1207L/9L connection

The mains power connection (1 x 230 V) is via terminals X1/ L1, L2/N, \ominus . For technical specifications see Data Table.



Warning!

Never connect 400/460 V to terminals X1/L1 and X1/N. The excessive voltage would destroy the equipment.

VF1404L... VF1414L connection

The mains power connection (3 x 400/460V) is via terminals X1/ L1, L2, L3, \ominus . For technical specifications see Data Table.

VF1418L ... VF1445L connection

The mains power connection (3 x 400/460V) is via terminals X0/ L1, L2, L3, \ominus . For technical specifications see Data Table.

2.3.2 Braking Chopper

General:

If the rotor speed is higher than the corresponding stator speed, the motor returns energy to the inverter. In this mode the motor is braked by the inverter. The internal braking chopper converts the regenerative braking energy into heat in a load resistor.

All SMARTDRIVE inverters in the 2.2 kW - 22 kW range are fitted with an internal braking chopper. For technical specifications see power table.

Accessories:

To ensure interference-free braking operation even in dynamic applications it is sometimes necessary for an additional external braking resistor to be fitted, depending on the braking energy level to be dissipated.

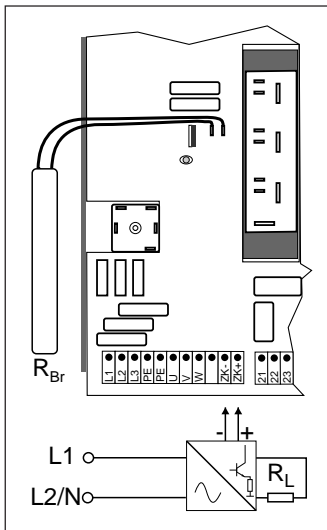

Warning:

The braking resistor must not be of a lower value than $R_{Br} = 90 \Omega$. The braking resistor becomes very hot and all assemblies in its vicinity must be installed at a suitable distance.

For connection see diagram.

It also the possibility of connecting an external braking chopper For special applications eg. BC2300 or BC3000. The length of cable between the inverter and the braking chopper (intermediate DC circuit) must not exceed 2 m.



2.3.3 Motor Connection



General

Standard three-phase motors in the range up to 4 kW are produced in accordance with IEC34 for various mains supplies in Delta (3*230 V) and in Star (3*400 V) formats.

Standard three-phase motors in the range above 4 kW are produced in accordance with IEC34, for various mains supplies in Delta (3*400 V) and in Star (3*660 V) formats

Information on connecting special three-phase motors which do not comply with the IEC34 standard must be obtained from the motor manufacturer.



To comply with electromagnetic suppression regulations, the motor terminal box must be HF-radiation-proof. Therefore, it must be manufactured either from metal or metallized plastic.

Cable bushing for the motor cable at the terminal box must be of the conductive threaded union type with laced screening.

VF1207L/9L connection

The motor is connected at terminals X1/ \oplus , U, V, W.
The motor connection must be Delta (3*230 V).

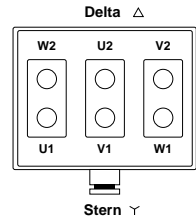

VF1404L ... VF1410L connection

The motor is connected at terminals X1/ \oplus , U, V, W.
The motor connection must be Star (3*400 V).

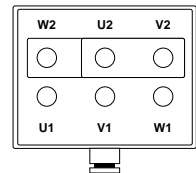

VF1414L connection

The motor is connected at terminals X1/ \oplus , U, V, W.
The motor connection must be Delta (3*400 V).

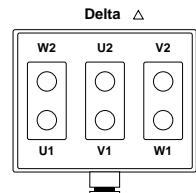

VF1418L...1445L connection

The motor is connected at terminals X0/ \oplus , U, V, W.
The motor connection must be Delta (3*400 V)..

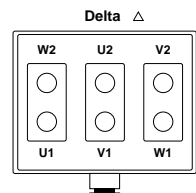

2.4 Control Connections

2.4.1 Specification

Connection	Specification
Reference output UR	10 V \pm 2%, not short circuit proof load up to 2 mA
Power supply output UV	24 V \pm 10%, short circuit proof load up to 200 mA
Frequence reference value input FSIN (analog)	cascading serveral inverters possible using voltage ref. value, resolution 10 BIT, deviation \pm 1,5%, software filter up to 50 ms
Frequency reference value input FSIN (digital)	Schmitt trigger input, LOW < 4 V, HIGH > 5 V (max.10 V), 0...1 kHz, 0... 10 kHz, pulse width min. 10 μ s, deviation \pm 8%, \pm 0,8%, software filter up to 50 ms
Digital control inputs STR, STL, S1IND, S2IND	Low < 3 V, High > 8 V (max. 30 V), current consumption (at 24 V) = 10 mA max., SPS compatible, +24 V logic to ground, hardware filter 3,3 ms, software filter 1x polling cycle
Digital frequency input SOUTF	LOW pulse, LOW level approx. 1V, pulse pause ration 1:1, 6 times output frequency, at rest HIGH = 24 V
Analog input SOUTA	output voltage 10 V, 50% overrange, load (up to 10 V) = 8 mA load (10...15 V) = 5 mA not short circuit proof, resolution 10 BIT
Digital control output S1OUT, S2OUT, S3OUT	S1OUT = driver output, function programmable, short circuit proof, load max. 80 mA, HIGH active S2OUT/S3OUT = open collector output, not short circuit proof, load = 50 mA max., LOW active, intern. pulled with 10 k Ω above 24 V, LOW level < 4,5V

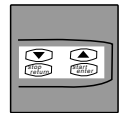

2.4.2 Function of FSINA Reference Value Input

Setting analog frequency reference value FSINA

The three-phase frequency is set using terminal X2/22. The input is matched to the specific type of drive at jumper strip X11. There are three possibilities:

1. Connection of a potentiometer (4,7... 10 k Ω)

X11 matching:

Position A

04-FSSEL = 0 factory setting

04-FSSEL = 2 with cable break safeguard

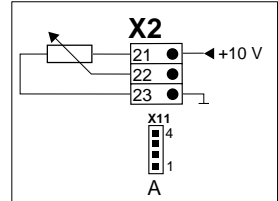

2. External voltage reference value 0(2)...10 V DC

X11 matching:

Position A: 0... 10 V

Position D: 0... 2 V

Position E: 2... 10 V

04-FSSEL = 0 factory setting

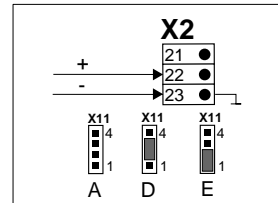

3. External current ref. value 0(4)...20 mA

X11 matching:

Position B: 0... 20 mA

Position C: 4... 20 mA

04-FSSEL = 0 factory setting

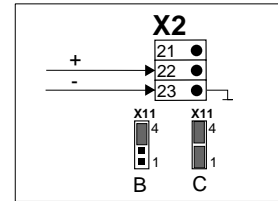

Position of jumper strip X11

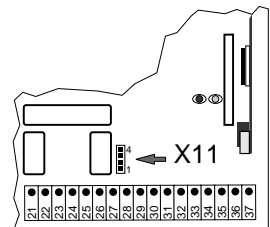

Note:

For a given direction of rotation the inverter can also be started from the frequency reference value input.

FS > 0,5 Hz → START

FS < 0,25 Hz → STOP



In addition to FSINA input matching using jumper strip X11 the equipment software provides matching facilities using the KEYPADs or the interface. Parameter 04-FSSEL (frequency reference value selector) determines the origin of the frequency reference value (see table). See also parameter description.



04-FSSEL	Function
0	analog input active, matching via X11
1	FSIN as pulse input direct active, ramp and filter functions switched off*
2	analog input with cable break safeguarding active
3	FSIN as frequency input 0 - 1 kHz active
4	FSIN as frequency input 0 - 10 kHz active
5	FSIN as PWM input 20 - 100% active
6	FSIN as PWM input 0 - 100% active
7	FSIN not active, reference value via KP100 (CTRL-menu)
8	Reference value set via interface
9 - 16	For setting the reference value, see Chapter 6, Page 6-4
17 - 22	correction of analog reference value via S1IND/S2IND (motor potentiometer function) active
23	inverted PWM input: 100% => FMIN, 20% => FMAX

*Hardware option required, please contact us for further details

Setting the digital frequency reference value FSINA(F)

1. Setting external freq. ref. value

0...1kHz

Scaling: FMIN → FMAX

0 ... 1 kHz

04-FSSEL = 3

Amplitude: 10 V max.

Pulse width: 10 μs min.

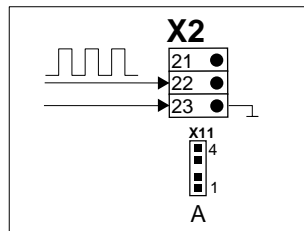

2. Setting external freq. ref. value

0 ... 10 kHz

Scaling: FMIN → FMAX

0 ... 10 kHz

04-FSSEL = 4

Amplitude: 10 V max.

Pulse width: 10 μs min.

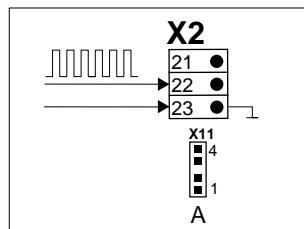

2.4.3 Control Functions using STR/STL



Mains switching with STL/STR

For safety reasons the inverter must not be switched on to the mains supply using the preset control function STL or STR. The start function only recognises the inverter when it has been activated **after** power on or self test.

The choice of direction of rotation is made by inputs STR or STL using two switching contacts as shown on the connection plan. Alternatively the choice of direction of rotation may also be made using two external voltage signals in accordance with the control connection details.

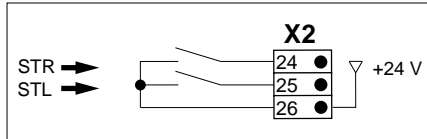

START

The inverter starts when both a control signal STL or STR and a reference value for the three-phase frequency of at least 0.5 Hz = 0.1 V are present at FSIN.

STOP

The inverter stops when the control signals STL or STR have been discontinued. The motor which is connected coasts on uncontrolled without any braking.

BRAKE/STOP

The inverter brakes the motor to a STOP when two control signals are present at STL and STR. A fresh start occurs when one of the two control signals is set to zero.

REVERSING

The direction of rotation reverses when the control signal is changed from one control input (eg. STL) to the other control input (eg. STR).

The overlap interval must be at least **8 ms**.

Truth table

STL	STR	Explanation
0	0	STOP, motor coasts
1	0	START, counterclockwise with RACC/RDEC
0	1	START, clockwise with RACC/RDEC
1	1	STOP
0	1	Reverse direction of rotation
1	0	

2.4.4 Control Functions via S1IND/S2IND

Choice of fixed frequencies FF2, FF3, FF4

In addition to the FSINA input the frequency design of value can also be preset using control inputs S1IND/S2IND as a fixed frequency. There is a choice of three fixed frequencies which are activated in accordance with the Truth Table.

The truth table relates to factory setting Parameter **31-KSEL = 0** (Data set selector).

Truth Table

S1IND	S2IND	Explanation	Range	Factory Setting
0	0	FSINA-Input Active*	0 to 999 Hz	FMAX = 50 Hz
1	0	FF2-Fixed Freq. Active	0 to 999 Hz	FF2 = 3 Hz
0	1	FF3-Fixed Freq. Active	0 to 999 Hz	FF3 = 15 Hz
1	1	FF4-Fixed Freq. Active	0 to 999 Hz	FF4 = 30 Hz



*Note setting of 04-FSSEL

Sequence Diagram

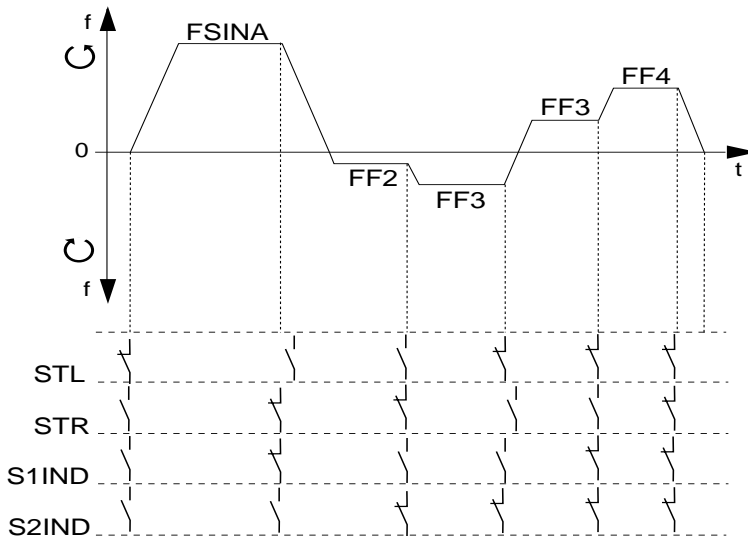

The number of fixed frequencies may be extended by FF5, FF6 and FF7. These may be selected by using the optional control input S3IND (OP5). The required option card is available to order.



Dataset Switching

The inverter has two data sets which can be switched using the control input SIIND/S2IND. Each data set has a total of eight parameters which may be set individually (see Parameter Description).

The Truth Table relates to Parameter **31-KSEL = 2** (Data Set Selector)

Truth Table



S1IND	S2IND	Explanation	Data Set
0	0	FSINA-input active	1 active
1	0	FF2-1 fixed freq. active	1 active
0	1	FSINA-input active	2 active
1	1	FF2-2 fixed freq. active	2 active

Ramp Switching

The data set switching facility means that the inverter also has 2 ramp pairs. The function of ramp switching is shown by the following sequence diagram (where 31-KSEL=2). For further information see Parameter Description

Sequence Diagram

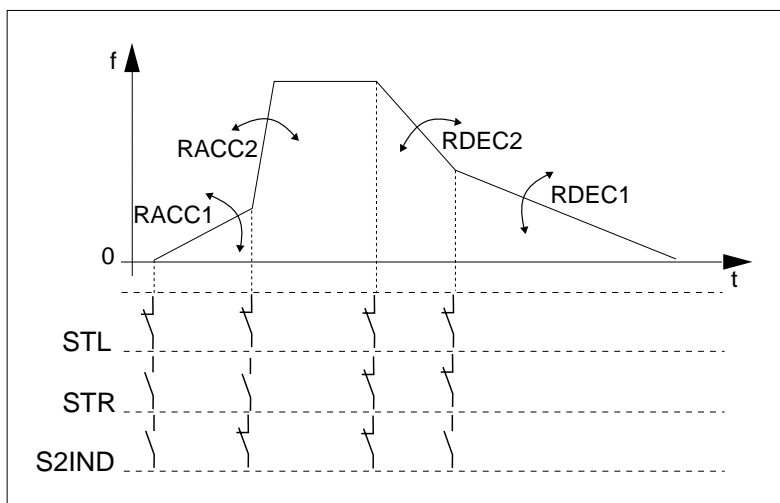

2.4.5 Signal Outputs

Ready Signal S1OUT (driver output HIGH active)

The output becomes inactive (relays drops off) in the case of mains or cable failure or inverter breakdown. The relay pulls in again when the fault is rectified and the mains supply is reset.

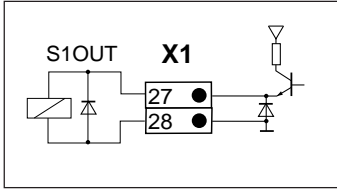

Frequency Limit Value S2OUT (Open Collector Output LOW active)

The indicator output is active (relay pulls in) when the rotating field frequency exceeds the programmed value of the fixed frequency 25-FF5 (WE=3 Hz) ($F > FF5$).

Frequency Reference Value reaches S3OUT

(Open Collector Output LOW Active)

The Output becomes active when the rotating field frequency reaches the prescribed frequency reference value FS ($F = FS \pm 0.5\text{Hz}$).

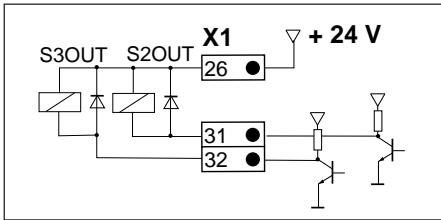

Programming:

All three outputs can be set using the KEYPAD or the interface to one of 10 different functions. The function description refers to the following factory settings

Parameter 62-S1OUT = 1

Parameter 63-S2OUT = 7

Parameter 64-S3OUT = 7



For further information see Parameter Description.

Analog Output SOUTA

The output works in the basic setting as an analog frequency output. It provides a DC voltage which is proportional to the output frequency of the inverter.

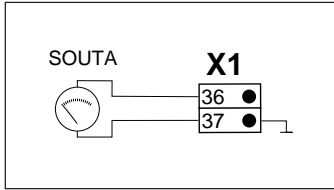

SOUTA	Explanation
0 V	F = 0 Hz
10 V	Inverter Start, F= FMAX
>10 V	Inverter Start, F= MAXF

Digital Frequency Output SOUTF

The output SOUTF supplies 24 V pulses. For each 1 Hz rotating field frequency 6 low pulses are fed to the frequency output.

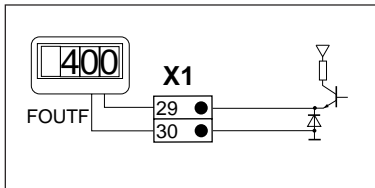

FSIN	SOUTF
< 5 Hz	30 Hz constant
5 - 260 Hz	30-1560 Hz linear
> 260 Hz	1560 Hz constant

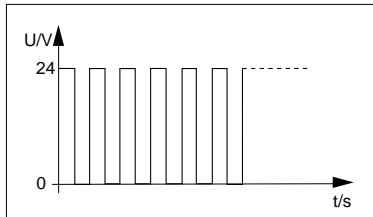

Programming

The SOUTA and SOUTF outputs may be programmed for additional functions using the KEYPAD or the interface. Parameter 61-SOUTA can be set using either output. In addition Parameter 69-KOUTA can be used for scaling the analog output SOUTA.

Factory Setting: 61-SOUTA = 9
 69-KOUTA = 100%

For further information see Parameter Description.

2.4.6 LUSTBus Connection

General

Standard inverters VF1000 Series L have a floating interface connection RS485. Inverters can be controlled through this interface in accordance with the LUSTBus data transmission protocol.

Terminal connections:

An external 24V DC supply (V_{DD}) is required to operate the interface.

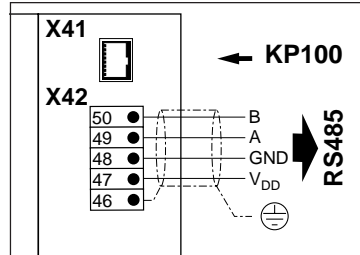

Technical Data:

	Code	RS485
Voltage supply, ext.	V_{DD}	24 VDC $\pm 10\%$
Current consumption	I	Transmitting 100 mA, Receiving 20 mA
Isolation	-	Galvanic function separation
Driver output	-	31 participants, distance < 1000 m
Transmission rate	-	variable 9600, 4800 or 2400 Baud
Isolation	-	as per VDE 0884, protection low voltage

2.4.7 INTERBUS-S Connection (C1)

General

The **C1 version** of the VF1000 inverter Series L has an INTERBUS-S coupling (IBS) with external 24V feed and a local bus interface. The inverter can be controlled through this interface in accordance with the INTERBUS-S data transmission protocol.

Layout:

An external 24V DC supply is required to operate the interface.
Terminal 54 = +24 VDC input
Terminal 53 = ground

- A** = IBS output, 15-pin
Sub D socket strip X51
- E** = IBS input, 15-pin
Sub D pin strip X52
- C** = IBS option print

Screening is laced through the plug housing.

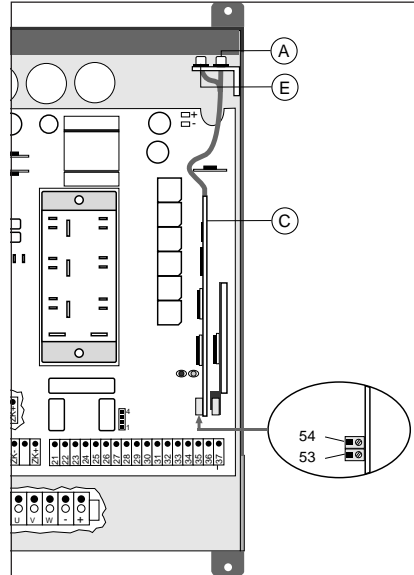

Connections:

D-SUB 15 pin, socket IBS output

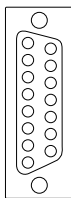

X51

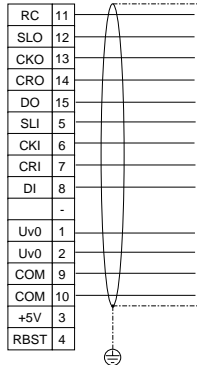

D-SUB 15 pin, plug IBS input

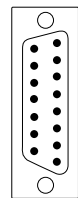
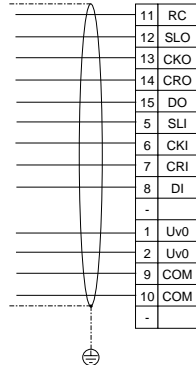

X52

Technical Data

	Code	VF1000 L, INTERBUS-S
Power supply, external	V_{DD}	24 VDC \pm 10%
Current consumption	I	120 mA max.
Interface	-	Local bus
Module Ident. No.	-	195
Data	-	Data words through process data channel (control word and Data - speed reference value) as per DRIVECOM specification
	-	PCP Data

2.4.8 CAN-Bus Connection (C2)

General:

The **C2 version** of the inverter VF1000 Series L can have a CAN-Bus coupling (CAN). The bus interface is isolated.

The bus is connected by two 9-pin Sub-D plug-in connectors as per CiA Draft Standard 102.V2.0.

This inverter can be operated by a CAL protocol in a network.

Layout:

An external 24V DC supply is required to operate the interface. Connection by means of a D-Sub plug.

A = CAN output,
9-pin Sub-D socket strip X61

E = CAN input,
9-pin Sub-D pin strip X62

C = CAN-Bus option print

Screening is laced through the plug housing.

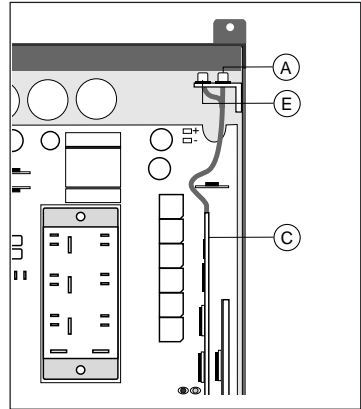

Connections:

D-SUB 9 pin, socket CAN output

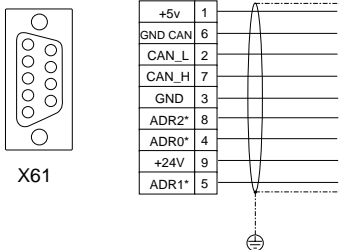

D-SUB 9 pin, plug CAN input

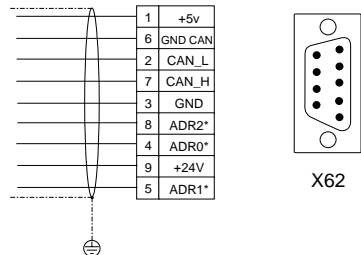

* Address preset, alternatively through DIP switches on options board (do not wire up if not required).

Allocating device addresses:

- a) using a parameter
- b) using DIP-switches on the CAN-Bus option print (see drawing)
- c) using a coded plug (Addresses 0 ... 7)

DIP5	DIP4	DIP3 ADR2	DIP2 ADR1	DIP1 ADR0	Address
-	-				
0	0	0	0	0	0
0	0	0	0	1	1
0	0	0	1	0	2
:	:	:	:	:	:
0	1	0	0	0	8
:	:	:	:	:	:
1	1	1	0	1	29

Note: DIP6 ...8 are without any significance.

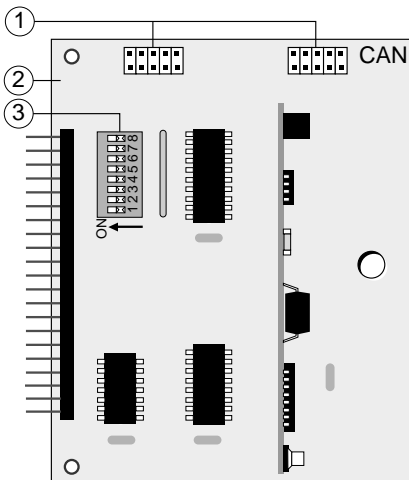

Nr.	Function
1	CAN-output-input
2	CAN-Bus option print
3	DIP-switch for device addresses

Technical Data

	Code	VF1000 L, CAN-Bus to ISO 11898	
Number of participants		30, maximum	
Power supply, external	V_{DD}	24 VDC $\pm 10\%$	
Stromaufnahme	I	100 mA max.	
Current consumption	-	up to 1 M bauds	
Transmission and processing speeds		Time on the bus	Time in the inverter
Control command and subsequent status scan			
- for 1 inverter		0,3 ms	8 ms
- for 30 inverters		9 ms	8 ms
Setting parameters			
- for 1 inverter		0,15 ms	approx. 30ms
- for 30 inverters		4,5 ms	approx. 30 ms

3 Operation and Fault Diagnostics

3.1 Operation Display

H1	H2	Meaning
○	●	Power off, no function
☀	●	Power is switched on, self-test after approx. 0.5 s., inverter ready
○	☀	inverter is started
☀	☀	Overload protection, I*t-monitoring active
○	☀	Switch-off on error, see H1 flashing for cause Chapter 3.2







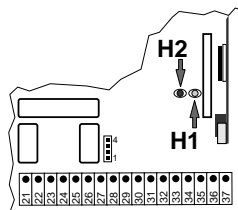

Location of LEDs:

H1 = yellow

H2 = green



3.2 Error Messages

H1 flashes	Error	Condition / Cause	Solution / Comment
	E-CPU	Error in CPU	Switch off mains power supply and switch on again (Reset)
	E-OFF	Power switched off or undervoltage	flashes until U DC link < 150V (VF12xxL) < 300V (VF14xxL)
	E-OC	Over current switch off, short-circuit	Check drive/motor cable
	E-OV	Over voltage, motor regenerative mode	Check power/drive
	E-OLM	Motor overloaded, I*t switch-off	Check drive / motor / ventilation
	E-OLI	Inverter overloaded I*t switch-off	Check drive/ventilation
	E-OTM	Motor temperature too high	Only possible if thermistor protection option fitted
	E-OTI	Inverter temperature too high	Inverter overloaded, check installation conditions
	E-EEP	Error in EE-PROM switch on again	Switch off mains supply and switch on again

Hold start/enter key down for at least 3 seconds to reset.

3.3 Warning Messages (no reaction from the unit to errors)

VF1000 control error

ATT1	Changing parameters in online operation (with the motor running) is not allowed.
ATT2	Controlling the motor through the KEYPAD in online operation is not allowed.
ATT3	Access to LUST SMARTCARD in online operation is not allowed.
ATT4	The system is in error status. Control through the KEYPAD is not allowed.
ATT5	Motor data for a selected function, e.g. I * R compensation, must be complete.
ERROR	Invalid pass word

Reset error by holding down the start/enter key.

Fehler bei SMARTCARD- Betrieb

ERR91	SMARTCARD is write-protected.
ERR92	Error in the plausibility check.
ERR93	SMARTCARD not readable, wrong inverter/servo regulator type.
ERR94	SMARTCARD not readable, parameters not compatible.
ERR96	Connection to SMARTCARD interrupted.
ERR97	SMARTCARD data invalid (CS test)
ERR98	Insufficient memory space on SMARTCARD (only MC6000)

Reset error by holding down the start/enter key.

Support:

If you should happen to experience difficulties in installing the frequency inverter, we shall be pleased to assist you as necessary. You can contact our specialists at the following address:

Lust Antriebstechnik GmbH
Gewerbestraße 5-9
D-35633 Lahnau / Germany

Telephone: ++49 6441/966111
Fax No.: ++49 6441/966137

3.4 Motor/Inverter Overload Protection (I*t Monitoring)

I * t monitoring provides electronic motor protection and inverter protection against high thermal loads. The triggering characteristic is shown in the diagram. The details refer to an output frequency of 50 Hz.

It should be noted that during continuous operation with frequencies < 40 Hz the motor requires forced cooling.

General rule:

Within any 10 minute period, with a continuous current of $I = 1.5 * I_N$ (150% overload), an overload of 1 minute is permissible.



Exception: Maximum overload VF1445L = 120%

Diagram:

Line A = VF1445L, Line B = all other inverter types

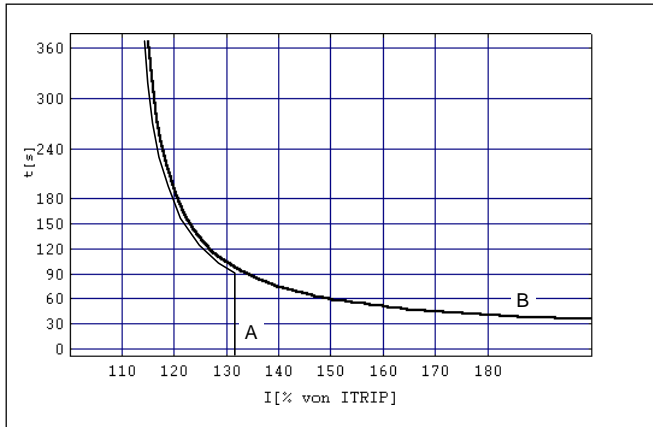

Programming:

The parameter 59-ITRIP is used for setting the I*t tripping current. This means that currents < I_N (rated device current) can be set. Consequently, motors of lower power than the rated device current can be protected effectively from overload. Factory setting:

$$59\text{-ITRIP} = I_N \text{ (rated device current)}$$



4 Using the KP100 KeyPAD

4.1 Layout

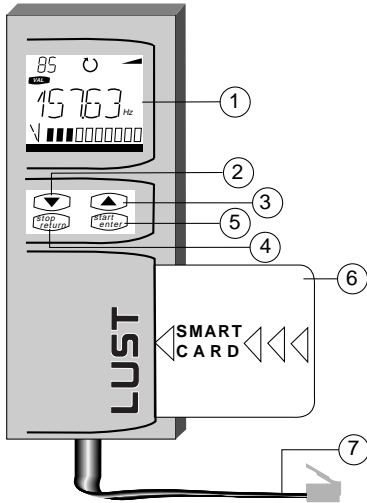

Item	Code	Function
1	LCD-Display	140 segments, backlit green/red
2	Down arrow key	Scroll back within the menu structure
3	Up arrow key	Scroll forwards within the menu structure
4	Stop/Return key	Stop (menu CTRL) Exit or leave selected menu
5	Start/Enter key	Start (menu CTRL) Confirm or Select menu
6	SMARTCARD	Chipcard data store, storage of device settings
7	Connecting cable	Maximum length 0.30m

Dimensions and Weight

	Code	Unit	KP100
Dimensions	WxHxT	mm	62x158x21
Weight		g	100
Protection			VBG4, IP20
Ambient Temperature		°C	0 ... 40

4.2 General

4.2.1 Menu Options

After power on the device carries out a selftest (display backlit red).

The **VF1000** then goes straight to the current value of the output frequency (display backlit green).

The menu option VAL is active. By tapping the Stop/Return key twice the display will change to menu and opens up the selection of other menu options.

VAL	= Display Actual Values
PARA	= Change Parameter Setting
CTRL	= Control Motor using KEYPAD
CARD	= Load device settings/store with SMARTCARD

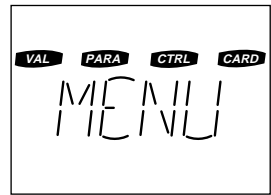

4.2.2 Key Functions

The arrow keys are used for selecting menu options and specific parameters and enable changes to be made to them.

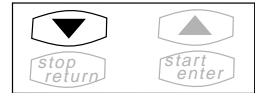

Tap them once and move to the next menu option or parameter or the smallest increment in a parameter value.

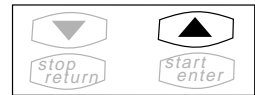

If a key is held down it will scroll automatically and stop when the key is released. The Stop/Return key is used for leaving the menu options for exit from parameter changes (old value is retained).

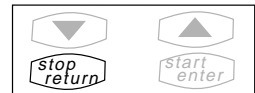

The start/enter key is used for calling up menu options or parameters and storing changes.

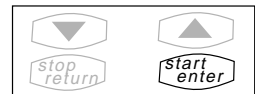

4.2.3 LCD Display

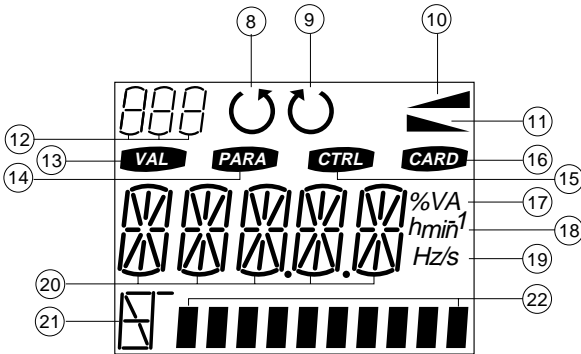

Item	Description	Function
8	Counterclockwise	Monitoring display for output Counterclockwise active
9	Clockwise	Monitoring Display for output rotating field, Clockwise active
10	Acceleration Ramp	Monitoring Display, active during acceleration
11	Braking Ramp	Monitoring Display, active during braking
12	3-digit Display	7 Segment Display for actual values, parameter numbers
13	VAL Menu	Display actual values e.g. frequency voltage, current
14	PARA-Menu	Change Parameter Setting
15	CTRL-Menu	Control Motor by KEYPAD
16	CARD-Menu	Load device setting/store with SMARTCARD
17	Physical Unit to Item 20	Shows % V, A, VA with automatic allocation
18	Physical Unit to Item 20	Shows h, min ⁻¹ (rpm) with automatic allocation
19	Physical Unit to Item 20	Shows Hz, s, Hz/s with automatic allocation
20	5-digit display	15-segment display for parameter names and values
21	Barchart	Shows formula characters and physical unit to item 22
22	10 position Barchart display	Shows parameter values, frequency, voltage, apparent or effective currents

4.3 Menu Structure

4.3.1 Overview

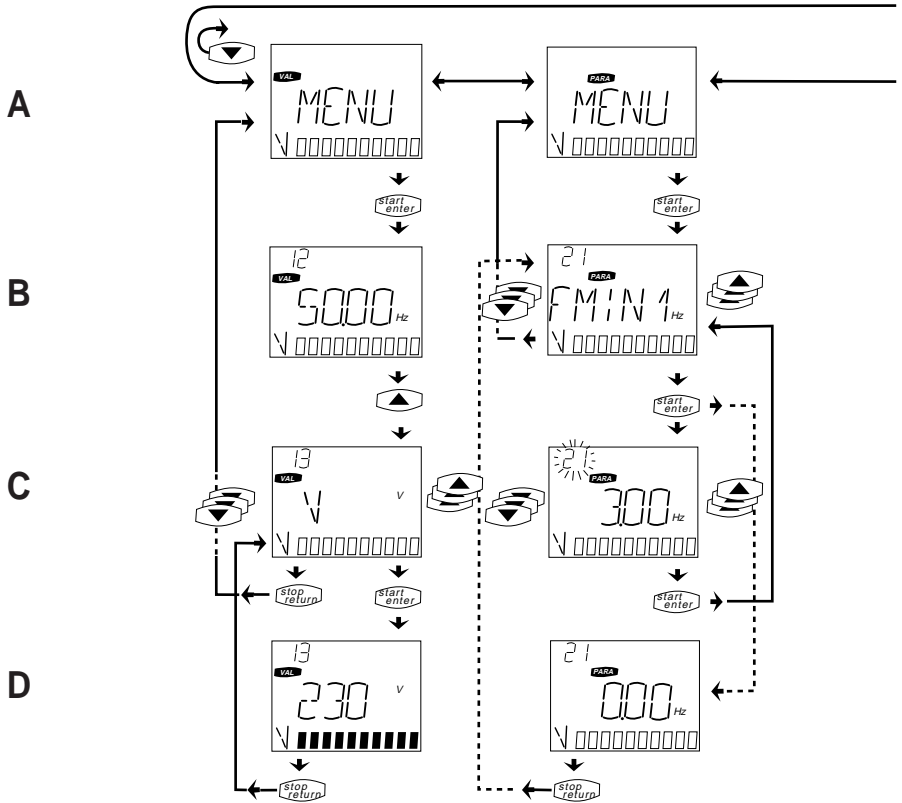

A	Menu VAL (actual value) selected	Menu PARA selected
B	Display actual value, with arrow key change to	Select parameter e.g. FMIN1
C	Next actual value parameter	Change Parameter setting in off-line mode (Inverter stop)
D	Detect new actual value	Read Parameter setting in off-line mode (Inverter start)

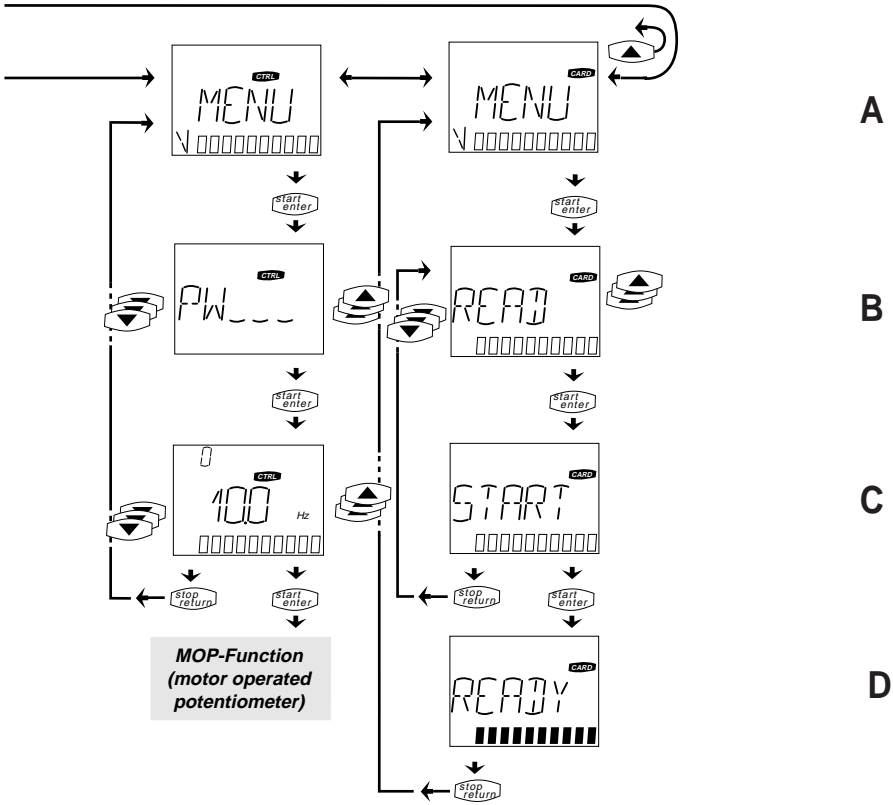

A Menu CTRL (Control Motor via KEYPAD) selected	Load/store menu device setting using the SMARTCARD (SC)
B Enter password Factory Setting = 573	READ = Load device setting from SC WRITE = Save device setting to SC LOCK = write protect SC UNLCK = remove write protect
C Enter Frequency Reference Value (KEYPAD) e.g. (10 Hz)	Start selected function with start/enter key
D Activation of Motor Potentiometer function (see next page)	Function completed error free

4.3.2 MOP - Function

After password confirmation the control terminal is blocked. The pre-set frequency reference value (KEYPAD) may be for example 10 Hz. Start inverter by tapping the start/enter key.

Actual value (small display) and direction of rotation clockwise are also indicated.

Increase speed reference value with arrow key to e.g. 50 Hz.

Inverter follows with acceleration ramp increase.

Reduce speed reference value using arrow keys.

Inverter follows with braking ramp for deceleration. At < 0.0 Hz the inverter changes the direction of the rotating field.

Increase speed reference value (counterclockwise) to e.g. 10Hz.

Prefix (--) also shows counterclockwise direction

Press stop/return key and release. Inverter brakes the motor to a stop.

The motor potentiometer function is reactivated with the start/enter key

From overview
CTRL-Menü

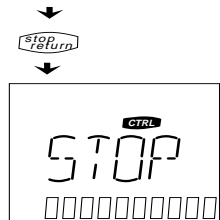
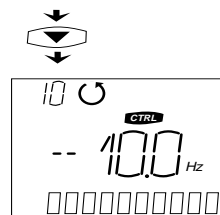
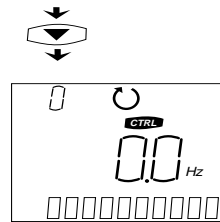
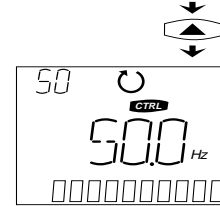
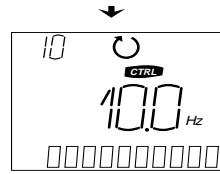

to overview
CTRL-Menü

5 Parameter List

5.1 Operating Level 1

Display parameters

Code	Name	Unit	Display range	Page	Factory setting	Client setting
<i>Actual values</i>						
10-G	Scaled frequency	-	0 to 65535	6-5		
12-F	Output frequency	Hz	0,0 to 999,0	6-5		
13-U	Output voltage	V	0 to 460	6-5		
14-IS	Apparent current	A	0,0 to 52,0	6-5		
15-IW	Effective current	A	0,0 to 52,0	6-5		
16-PW	Effective power	W	0 to 22000	6-5		
17-UZK	DC link voltage	VDC	0 to 900	6-5		
18-TIME	Switch on time after reset	h	0,0 to 960,0	6-6		
19-TOP	Operating hours	h	0 to 60000	6-6		
<i>Device Data</i>						
91-TYPE	Inverter type	-	15 types possible	6-18		
92-REV	Software version	-	-	6-18	See inside cover	
95-ERR1	Last error	-	0-0,0 to 9-1,5 11-0,0 to 11 -1,5	6-18		

Commissioning parameters

Code	Name	Unit	Setting range	Page	Factory setting	Client setting
1-MODE	Operating mode	-	0 to 3	6-1	1	
<i>Frequencies</i>						
20-FF2-1	Fixed frequency 2	Hz	0,0 to 999,0	6-6	3	
21-FMIN1	Minimum frequency	Hz	0,0 to 999,0	6-6	0	
22-FMAX1	Maximum frequency	Hz	4,0 to 999,0	6-6	50	
23-FF3	Fixed frequency 3	Hz	0,0 to 999,0	6-6	15	
24-FF4	Fixed frequency 4	Hz	0,0 to 999,0	6-6	30	
25-FF5	Comparison frequency for S2OUT	Hz	0,0 to 999,0	6-6	3	
<i>Ramps</i>						
32-RACC1	Acceleration ramp 1	Hz/s	0,1 to 999,0	6-7	20	
33-RDEC1	Delay ramp 1	Hz/s	0,1 to 999,0	6-7	20	
36-RSTOP	STOP delay ramp	Hz/s	0,0 to 999,0	6-8	0	
<i>Characteristics</i>						
41-V/FC	U/F selector	-	1 and 4	6-8	1	
42-VB1	Start voltage (Boost 1)	%	0,0 to 25,0	6-9	*	
43-FN1	Rated frequency	Hz	15,0 to 960,0	6-9	50	
44-VN1	Rated voltage	V	220,0 to 460,0	6-9	*	

* depends on inverter type

5.2 Operating Level 2

Code	Name	Unit	Setting range	Page	Factory setting	Client setting
<i>Reverence value input</i>						
4-FSSEL	Frequency reference value selector	-	0 to 23	6-1	0	
<i>Actual values</i>						
9-BARG	Bar chart	-	6 actual values	6-4	13-U	
<i>Frequencies</i>						
20-FF2-1	1st fixed frequency 2	Hz	0.0 to 999.0	6-6	3	
21-FMIN1	Minimum frequency	Hz	0.0 to 999.0	6-6	0	
22-FMAX1	Maximum frequency	Hz	4.0 to 999.0	6-6	50	
23-FF3	Fixed frequency 3	Hz	0.0 to 999.0	6-6	15	
24-FF4	Fixed frequency 4	Hz	0.0 to 999.0	6-6	30	
25-FF5	Comparison freq. S2OUT	Hz	0.0 to 999.0	6-6	3	
26-FF6	Control frequency	Hz	0.0 to 999.0	6-6	0	
27-FF2-2	2nd fixed frequency 2	Hz	0.0 to 999.0	6-6	5	
28-FMIN2	Minimum frequency 2	Hz	0.0 to 999.0	6-6	0	
29-FMAX2	Maximum frequency 2	Hz	4.0 to 999.0	6-6	50	
30-FF7	Fixed frequency FF7	Hz	0.0 to 999.0	6-6	50	
<i>Ramps</i>						
31-KSEL	Data set selector	-	0 to 3	6-7	0	
32-RACC1	Acceleration ramp 1	Hz/s	0.1 to 999.0	6-7	*	
33-RDEC1	Delay ramp 1	Hz/s	0.1 to 999.0	6-7	*	
34-RACC2	Acceleration ramp 2	Hz/s	0.1 to 999.0	6-8	*	
35-RDEC2	Delay ramp 2	Hz/s	0.1 to 999.0	6-8	*	
36-RSTOP	STOP delay ramp	Hz/s	0.0 to 999.0	6-8	*	
<i>Characteristics</i>						
38-THTDC	Switch-off delay	s	0.0 to 120.0	6-8	0	
39-VHTDC	DC hold voltage	%	1 to 25	6-8	4	
41-V/FC	U/F selector	-	1 and 4	6-8	1	
42-VB1	Start voltage (Boost 1)	%	0.0 to 25.0	6-9	*	
43-FN1	Rated frequency 1	Hz	15 to 960	6-9	50	
44-VN1	Rated voltage 1	V	220.0 to 460.0	6-9	*	
45-VB2	Start voltage (Boost 2)	%	0.0 to 25.0	6-9	*	
46-FN2	Rated frequency 2	Hz	15 to 960	6-9	50	

* depends on inverter type

Note:

To set all editable parameters to factory setting, set the 71-PROG parameter to 1 and acknowledge the parameter change by pressing the start/enter key ("wait" message).

Code	Name	Unit	Setting range	Page	Factory setting	Client setting
<i>Special functions</i>						
48-IXR	I*R compensation	-	0 to 3	6-10	0	
49-SC	Slip compensation	-	0 to 2	6-11	0	
50-IN	Motor rated current	A	3.0 to 45.0	6-11	*	
51-COS	Power factor x100	%	0 to 100	6-11	82	
52-NN	Motor rated speed	RPM	0 to 24000	6-11	*	
53-KIXR	Correction factor for I*R compensation	-	0.0 to 30.0	6-12	*	
54-KSC	Correction factor for slip compensation	%	0.0 to 20.0	6-12	*	
55-ISEL	Current controller selector	-	0 to 5	6-12	0	
56-ILIM	Current limit	A	5 to 52	6-13	*	
57-FILIM	Minimum decrease frequency	Hz	0.0 to 999.0	6-13	15	
58-RILIM	Delay ramp for current control	Hz/s	0.1 to 999.0	6-13	50	
59-TRIP	I*t monitoring	A	3.5 to 43,0	6-14	*	
<i>Signal outputs</i>						
61-SOUTA	Frequency/analog output	-	0 to 14	6-15	1	
62-S1OUT	Output 1 digital	-	0 to 10	6-15	1	
63-S2OUT	Output 2 digital	-	0 to 10	6-15	7	
64-S3OUT	Output 3 digital	-	0 to 10	6-15	7	
67-FST	Filter time constant	-	0 to 4	6-16	2	
69-KOUTA	SOUTA scaling	%	0 to 200	6-16	100	
<i>Program functions</i>						
71-PROG	Special programs	-	0 to 2	6-16	0	
72-START	Start options	-	0 to 7	6-17	0	
74-PWM	Switching frequency	-	0 to 2	6-18	*	
86-KG	Scaling factor for 10-G	-	0 to 1000	6-18	0	
87-DISP	Continuously stored actual value display	-	all display parameters	6-18	12-F	
88-PSW1	Password 1 <PARA>	-	0.0 to 999.0	6-18	0	
89-PSW2	Password 2 <CTRL>	-	0.0 to 999.0	6-18	573	
94-MAXF	Absolute max. freq.	Hz	0.0 to 999.0	6-19	0	

* depends on inverter type

5.3 Inverter-Type-Dependent Parameters

Code	Code	Unit	Factory setting	Page	Inverter type
42-VB1		%	4	6-9	VF1207L, VF1209L, VF1404L, VF1406L, VF1408L, VF1410L, VF1414L
42-VB1		%	3	6-9	VF1418L, VF1424L
42-VB1		%	2	6-9	VF1432L, VF1445L
45-VB2		%	4	6-9	VF1207L, VF1209L, VF1404L, VF1406L, VF1408L, VF1410L, VF1414L
45-VB2		%	3	6-9	VF1418L, VF1424L
45-VB2		%	2	6-9	VF1432L, VF1445L
44-VN1		V	220	6-9	VF1207L, VF1209L
44-VN1		V	380	6-9	VF1404L bis VF1445L
47-VN2		V	220	6-9	VF1207L, VF1209L
47-VN2		V	380	6-9	VF1404L bis VF1445L
50-IN	59-TRIP	A	6,8	6-11	VF1207L
50-IN	59-TRIP	A	9,5	6-11	VF1209L
50-IN	59-TRIP	A	3,9	6-11	VF1404L
50-IN	59-TRIP	A	5,6	6-11	VF1406L
50-IN	59-TRIP	A	6,8	6-11	VF1408L
50-IN	59-TRIP	A	8,9	6-11	VF1410L
50-IN	59-TRIP	A	12,5	6-11	VF1414L
50-IN	59-TRIP	A	16,5	6-11	VF1418L
50-IN	59-TRIP	A	23	6-11	VF1424L
50-IN	59-TRIP	A	30	6-11	VF1432L
50-IN	59-TRIP	A	43,5	6-11	VF1445L
52-NN		UPM	1480	6-11	VF1207L, VF1209L, VF1445L
52-NN		UPM	1420	6-11	VF1404L, VF1406L, VF1408L
52-NN		UPM	1430	6-11	VF1410L
52-NN		UPM	1440	6-11	VF1414L
52-NN		UPM	1450	6-11	VF1418L
52-NN		UPM	1460	6-11	VF1424L, VF1432L

Note:

To set all editable parameters to factory setting, set the 71-PROG parameter to 1 and acknowledge the parameter change by pressing the start/enter key ("wait" message).

Code	Code	Unit	Factory setting	Page	Inverter type
53-KIXR		-	5	6-12	VF1207L, VF1209L, VF1404L, VF1406L, VF1408L
53-KIXR		-	3,5	6-12	VF1410L
53-KIXR		-	2,5	6-12	VF1414L
53-KIXR		-	1,8	6-12	VF1418L
53-KIXR		-	1,1	6-12	VF1424L
53-KIXR		-	0,6	6-12	VF1432L
53-KIXR		-	0,4	6-12	VF1445L
54-KSC		%	5	6-12	VF1207L, VF1209L
54-KSC		%	6,5	6-12	VF1404L, VF1406L, VF1408L
54-KSC		%	5,7	6-12	VF1410L
54-KSC		%	4,8	6-12	VF1414L, VF1418L
54-KSC		%	3,2	6-12	VF1424L
54-KSC		%	1,6	6-12	VF1432L, VF1445L
56-ILIM		A	9,3	6-13	VF1207L
56-ILIM		A	14,25	6-13	VF1209L
56-ILIM		A	5,3	6-13	VF1404L
56-ILIM		A	8,4	6-13	VF1406L
56-ILIM		A	10,2	6-13	VF1408L
56-ILIM		A	13,5	6-13	VF1410L
56-ILIM		A	18,75	6-13	VF1414L
56-ILIM		A	24,75	6-13	VF1418L
56-ILIM		A	34,5	6-13	VF1424L
56-ILIM		A	45	6-13	VF1432L
56-ILIM		A	54,75	6-13	VF1445L

6 Parameter Description

01-MODE Operating Mode [decimal]

MODE determines the control options of the inverter and the operating level for the KP100 KEYPAD.

The parameters are divided into three operating levels. Level 1 contains the most important parameters for installation. Level 2 in addition to changing level 1 also contains parameters for access to other parameters and special functions and control functions, for example data set switching or programming the control outputs.

Level 3 is reserved for interface parameters (SIO-Operation) and special parameters. Please contact us for further details.

01-MODE = 1 -> Operator Level 1 Installation level
01-MODE = 2 -> Operator Level 2 Special and control functions
01-MODE = 3,0 -> Operator Level 3 SIO - Operation via interface

6.1 Reference Value Input

04-FSSEL Frequency reference value selector

Provides the choice between various types of reference value (analog, frequency or PWM signal) and their means of input (KEYPAD, SIO...).

04-FSSEL	Function
0	Analog input active, matching via X11
1	FSIN as pulse input direct active, ramp and filter functions switched off *
2	Analog input with cable break safeguarding active
3	FSIN as frequency input 0 to 1 kHz active
4	FSIN as frequency input 0 to 10 kHz active
5	FSIN as PWM input 20 to 100% active
6	FSIN as PWM input 0 to 100% active
7	FSIN not active, reference value via KP100 (CTRL-menu)
8	Reference value set via interface
9 - 16	For setting the reference value, see Chapter 6, Page 6-4
17 - 22	Correction of analog reference value via S1IND/S2IND (motor potentiometer function) active
23	Inverted analog input: 10V => FMIN, 0V => FMAX

04-FSSEL = 0

Input FSIN is active as an analog input. Adjustment to 0(2)...10V or 0(4)...20 mA via jumper strip X11.

Block Diagram Reference Value Input

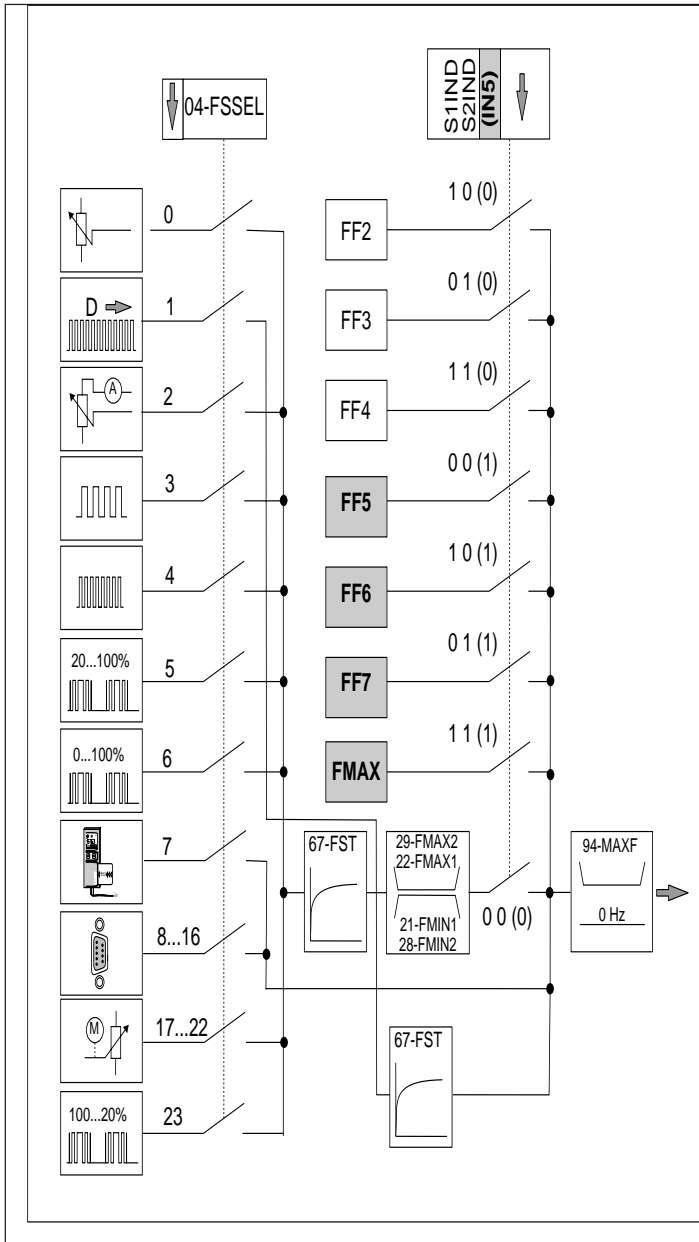

*only version OP5

04-FSSEL = 1

FSIN input operates as direct frequency input. The frequency signal fed in switches the output rotating field without delay. That means that the starting and braking ramps and also the frequency range (FMIN/FMAX) are determined externally.

Warning: This function switches off all the limits which protect the device. Feeding in an incorrect signal can overload the drive or damage it.



04-FSSEL = 2

Input FSIN is active as an analog input with cable break safeguarding specially for potentiometer use. In the case of cable break the inverter brakes the motor to STOP.

04-FSSEL = 3

Input FSIN operates as frequency input.
FMIN = 0 Hz FMAX = 1kHz

04-FSSEL = 4

Input FSIN operates as frequency input
FMIN = 0 Hz FMAX = 10kHz

04-FSSEL = 5

Input FSIN operates as pulse input for pulse width modulated signal.
FMIN = 20% PWM FMAX = 100% PWM (see diagram)

04-FSSEL = 6

Input FSIN operates as pulse input for pulse width modulated signal
FMIN = 0% PWM FMAX = 100% PWM (see diagram)

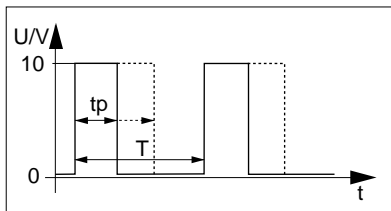

$$F = (F_{MAX} * k) + F_{MIN}$$

$$k = \frac{tp}{T}$$

- FMAX -> k = 1
- FMIN -> k = 0 (04-FSSEL = 6)
- FMIN -> k = 0,2 (04-FSSEL = 5)

04-FSSEL = 7

Input FSIN is not active. When the motor potentiometer function is started using the CTRL menu of the KEYPAD, 04-FSSEL = 7 is automatically set and on leaving it again is reset to 04-FSSEL = 0.

04-FSSEL = 8

Input FSIN and KEYPAD input are not active. The reference can only be set externally via the interface.

04-FSSEL = 9

The reference value is set to the value from 20-FF2-1 or 27-FF2-2 (note data record changeover 31-KSEL). Input FSIN is not active.

04-FSSEL = 10

The reference value is set to the value from 23-FF3. Input FSIN is not active.

04-FSSEL = 11

The reference value is set to the value from 24-FF4. Input FSIN is not active.

04-FSSEL = 12

The reference value is set to the value from 25-FF5. Input FSIN is not active.

04-FSSEL = 13

The reference value is set to the value from 26-FF6. Input FSIN is not active.

04-FSSEL = 14

The reference value is set to the value from 21-FMIN1 or 29-FMIN2 (note data record changeover 31-KSEL). Input FSIN is not active.

04-FSSEL = 15

The reference value is set to the value from 22-FMAX1 or 29-FMAX2 (note data record changeover 31-KSEL). Input FSIN is not active.

04-FSSEL = 16

The reference value is set to the value from 30-F7. Input FSIN is not active.

04-FSSEL = 17

Input FSIN active (basis reference value). The design reference value can be increased continuously using S1IND and reduced continuously using S2IND (reference value offset with motor potentiometer function).

04-FSSEL = 18

This has the same function as 04-FSSEL = 17 but with the following addition: If S1IND and S2IND are both activated simultaneously the reference value is reset to the basic reference value (reference value offset = 0).

04-FSSEL = 19

This has the same function as 04-FSSEL = 18 with the following additions: With the reference value offset and power off this offset is stored until it is changed or reset using S1IND or S2IND.

04-FSSEL = 20

This has the same function as 04-FSSEL = 18 and 19.

04-FSSEL = 21

This has the same function as 04-FSSEL = 18 with the following addition:
When the inverter stops the reference value is reset to the base reference value (reference value offset = 0).

04-FSSEL = 22

This has the same function as 04-FSSEL = 18 and 21.

04-FSSEL = 23

The input FSIN operates as an inverted analog input
10V = FMIN 0V = FMAX

6.2 Actual Values

09-BARG Barchart Display [Decimal]

The following parameters can be displayed in the barchart display.

09-BARG	Function	Code
STAT	Display as bit pattern	see Fig. 1
12-F	Output frequency as analog bar	< F >
13-V	Output voltage as analog bar	< V > Factory setting
14-IS	Apparant current as analog bar	< I >
15-IW	Effective current as analog bar	< I >
SIN	Display as bit pattern	see Fig. 2

Fig. 1

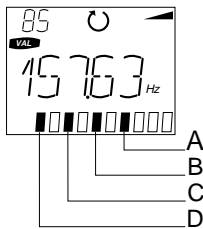

- A -> Reference value achieved
- B -> 12-F > 23-FF5
- C -> Current limit value achieved
 $I_s > 110\% I_N$
- D -> Regenerative current

Fig. 2

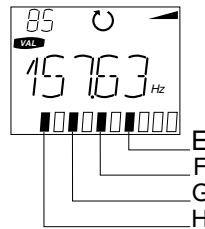

- E -> S1IND active
- F -> S2IND active
- G -> S1OUT active
- H -> S2OUT active

10-G Scaled Frequency

Shows the current output frequency 12-F multiplied by the factor from parameter 86-KG. No decimal places or physical units are displayed.

$$(10-G) = (12-F) * (86-KG)$$

12-F Output Frequency [Hz]

Displays the current output frequency. After a switch off on error the actual value present immediately before switch off is stored (hold function).

13-V Output Voltage [V]

Displays the current output voltage. The output voltage is held constant independent of the DC voltage if there is a control reserve present (DC compensation). After a switch off on error the actual value present immediately before switch off is stored (hold function).

14-IS Phase Current [A]

Displays the current phase apparent current. After a switch off on error the actual value present immediately before switch off is stored (hold function).

15-IW Effective Current [A]

Displays the current phase effective current. After a switch off on error the actual value present immediately before switch off is stored (hold function).

16-PW Effective Current

Displays the effective power produced by the inverter.

$$(16 - PW) = \sqrt{3} * (15 - IW) * (13 - V)$$

17-VZK Intermediate Circuit Voltage [VDC]

Displays the current intermediate circuit voltage (DC). After a switch off on error the actual value present immediately before switch off is stored (hold function).

18-TIME Time on since reset [0.1 H]

Displays time on since the last time the mains supply was switched on.

19-TOP Operating Hours [h]

Displays the total operating hours. The maximum value of the operating hour counter is 60000. When it reaches this value it remains unchanged.

6.3 Frequencies

20-FF2-1 Fixed Frequency FF2-1 [Hz]

Parameter of first data set.

Selectable as reference value using S1IND = 1 and S2IND = 0

21-FMIN1 Minimum frequency for analog ref. value setting [Hz]

Parameter of first data set. Setting reference value FSIN=0(2) V or 0(4) mA corresponds to an output frequency of FMIN.

22-FMAX1 Maximum frequency for setting analog ref. value [Hz]

Parameter of first data set. Setting reference value FSIN=10V or 20 mA corresponds to an output frequency of FMAX. In Version OP5 it can be selected via S1IND = 0, S2IND = 1 and S3IND = 1 (additional input on options card).

23-FF3 Fixed Frequency FF3 [Hz]

Selectable as reference value using S1IND = 0 and S2IND = 1

24-FF4 Fixed Frequency FF4 [Hz]

Selectable as reference value using S1IND = 1 and S2IND = 1

25-FF5 Fixed frequency FF5 [Hz]

Frequency threshold for programmable output S1OUT and S2OUT and S3OUT (see also 62-S1OUT, 63-S2OUT, 64-S3OUT)

26-FF6 Fixed Frequency FF6 [Hz]

Frequency threshold for data set switching where 31-KSEL = 1. In Version OP5 it can be selected via S1IND = 0, S2IND = 1 and S3IND = 1 (additional input on options card).

27-FF2-2 Fixed Frequency FF2-2 [Hz]

Parameter of second data set. Selectable as reference value using S1IND = 1 and S2IND = 0

28-FMIN2 Minimum frequency for setting analog ref. value (Hz)

Parameter of second data set (see also 21-FMIN1)

29-FMAX2 Maximum frequency for setting analog ref. value (Hz)

Parameter of second data set (see also 21-FMAX1)

30-FF7 Fixed frequency FF7 [Hz]

Can be selected as a reference value via 04-FSSEL = 16. In Version OP5 it can be selected via S1IND = 0, S2IND = 1 and S3IND = 1 (additional input on options card).

6.4 Ramps

31-KSEL Data Set Selector

The data set selector determines the control value for data set switching. Possible control values for data set switching are:

31-KSEL	Function	Application example
0	Data set switching inactive, always data set 1	Standard, factory set
1	Switching to second data set when 12-F > 26-FF6	Heavy load start
2	Switching of data set using S1IND and S2IND	Alternate use of 2 motors on one inverter
3	Switching to second data set for counterclockwise operation (STL active)	Drive with load depending on direction of rotating

Two data sets are available with the following parameters.

Parameter	Data set 1	Data set 2
Minimum frequency	21-FMIN1	28-FMIN2
Minimum frequency	22-FMAX1	29-FMAX2
Fixed frequency 2	20-FF2-1	27-FF2-2
Acceleration ramp	32-RACC1	34-RACC2
Braking ramp	33-RDEC1	35-RDEC2
Voltage rise	42-VB1	45-VB2
Rated voltage	44-VN1	47-VN2
Rated voltage	43-FN1	46-FN2

32-RACC1 Acceleration Ramp [Hz/s]

Parameter of first data set

33-RDEC1 Deceleration Ramp [Hz/s]

Parameter of first data set

32-RACC2 Acceleration Ramp [Hz/s]

Parameter of second data set

33-RDEC2 Deceleration Ramp [Hz/s]

Parameter of second data set

Ramp setting without data record changeover (31-KSEL=0)

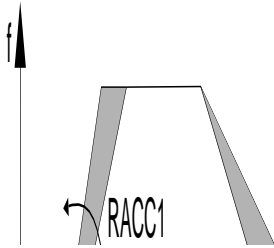

Ramp setting with data record changeover (31KSEL = 1.2 or 3)

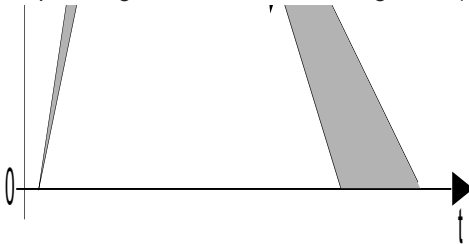

36-RSTOP Stop Ramp [Hz/s]

When the stop ramp (36-RSTOP > 0) is activated the inverter executes a deceleration ramp of gradient 36-RSTOP after setting the control inputs STR and STL to 0. A subsequent DC current hold is possible using 38-THTDC > 0. If 36-RSTOP = 0 the motor coasts on when STL and STR are set to 0.

6.5 Characteristics

38-THTDC DC Current Hold Switch Off Delay [s]

DC current hold is active after the value has dropped below the switch off current ($F < 0,5\text{Hz}$). Braking can be from 33-RDEC1 or 36-RSTOP. The hold time can be set to a value up to 120 seconds. Continuous hold is not possible.

39-VHTDC DC Current Hold Voltage Level [%]

The output voltage for DC current hold can be set using parameter 39-VHTDC as a % of the rated voltage of the device.

41-V/FC Characteristic Selector [Decimal]

41-V/FC = 1 -> linear voltage frequency characteristics
4 -> quadratic voltage frequency characteristics

See also the diagrams on the right.

42-VB1 Voltage Rise [%]

Parameter of first data set. Voltage at frequency at 0 Hz. Rise in torque in start up range.

See also diagrams below.

43-FN1 Rated Frequency [Hz]

Parameter of first data set. Frequency at which the inverter achieves the rated output voltage (setting of 44VN1).

See also diagrams below.

44-VN1 Rated Voltage [V]

Parameter of first data set. Initial setting of voltage which the inverter should have attained when it reaches 43-FN1.

See also diagrams below.

45-VB2 Voltage Rise [%]

Parameter of second data set. See 42-VB1.

See also diagrams below.

46-FN2 Rated Frequency [Hz]

Parameter of second data set. See 43-FN1.

See also diagrams below.

47-VN2 Rated Voltage [V]

Parameter of second data set. See 44-VN1.

See also diagrams below.

41-V/FC = 1

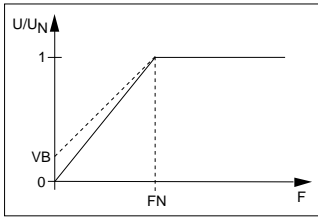

41-V/FC = 4

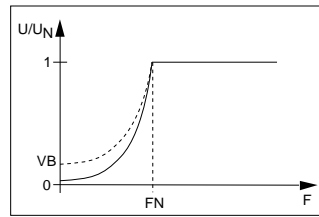

6.6 Special Functions

48-IXR I * R Compensation On/Off [Decimal]

- 48-IXR = 0 -> I*R Compensation inactive
- 1 -> I*R Compensation with first and second data set active
- 2 -> I*R Compensation with only first data set active
- 3 -> I*R Compensation with only second data set active

Condition for activation of I*R compensation: enter motor data (on type plate) **50-IN**, **51-COS** and **52-NN** for the load characteristics.

The aim of I*R compensation is to produce constant torque and reduce heating of the motor windings. This is achieved when the load characteristics as determined by the characteristic parameters are displaced by an amount ΔU which depends on the effective current. See Figure A.

$$\Delta U = (IW - IN * \text{COS}) * KIXR$$

- IW = 15-IW (effective current)
- IN = 50-IN (motor rated current)
- COS = 51-COS ($\cos\phi$ motor)
- KIXR = 53-KIXR (correction factor)

I*R Compensation begins from frequency $V_B \cdot F_N$. It increases in a linear fashion: from 0% of frequency $V_B \cdot F_N$ through to 100% at frequency $2 \cdot V_B \cdot F_N$. Beyond that it is 100%. See Figure B.

Figure A

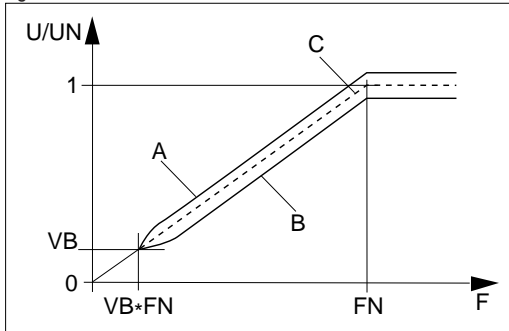

- A -> $IW >$ rated current (rated load)
- B -> $IW = 0$ (free speed)
- C -> non-compensated line

Figure B

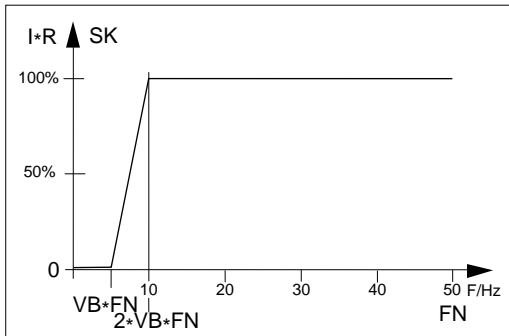

- Proportion of $I * R$ compensation ($I * R$)
- Proportion of slip compensation (SK)

49-SC Slip Compensation On/Off [Decimal]

- 49-SC = 0 -> Slip compensation inactive
1 -> Slip compensation active with first and second data set
2 -> Slip compensation only active with first data set only

Condition of activation of the Slip compensation:

Enter Motor data (type plate) **50-IN**, **51-COS** and **52-NN**.

Slip compensation is intended to maintain the speed constant irrespective of the load. In the basic setting range 0-FN a frequency ΔF which is proportionate to the effective current (15-IW) is added to the actual frequency (12-F).

In the field weakening range this ΔF is further corrected by the factor F/FN. The frequency increase calculated in this way is not displayed in the parameter 12-F.

Slip compensation starts at $VB * FN$. It increases in linear fashion from 0% at frequency $VB * FN$ to 100% at frequency $2 * VB * FN$. Beyond that it is 100%. See p. 50 Fig. B.

The increase in frequency is only limited by parameter 94-MAXF. Frequency correction is produced by the formula:

$$\Delta F = \frac{KSC * IW}{I_{NU}} * FN$$

In the basic setting range

IW = 15-IW (effective current)

I_{NU} = Inverter rated current

FN = 43-FN1 (rated frequency)

KSC = 54-KSC (correction factor)

F = 12-F (actual frequency)

In the field weakening range

$$\Delta F = \frac{KSC * IW}{I_{NU}} * \frac{F}{FN} * FN$$

50-IN Motor Rated Current [A]

Motor rated current from motor type plate.

Used in I * R compensation and slip compensation

51-COS Rated-cos ϕ [%]

Cosj from motor type plate (enter as %).

Used in I * R compensation and slip compensation.

52-NN Rated Speed (RPM)

Rated speed from motor type plate.

Used in I * R compensation and slip compensation.

53-KIXR I * R Compensation, Correction Factor [Decimal]

The KIXR correction factor corresponds to the resistance measured between the two motor lines. The correction factor can either be entered, or measured from the inverter.

Measurement starts when 48-IXR = 1 and 53-KIXR = 0

The inverter then produces a maximum 1/16th of the device rated voltage for approximately two seconds or allows a current of maximum 50-IN (entered rated current of motor) to flow. The measured value is automatically stored under 53-KIXR.



Warning:

During this measurement the motor shaft may turn slowly.

54-KSC Slip Compensation, Correction Factor [%]

The correction factor 54-KSC is scaled like the motor rated slip to the device rated current.

$$KSC = \left(\frac{n_{SYN} - n_N}{n_{SYN}} \cdot \frac{I_{UN}}{I_N \cdot \text{COS}} \right) \cdot 100 [\%]$$

n_{SYN} = Synchronous speed
 n_N = 52-NN (motor rated speed)
 I_{UN} = Inverter rated current
 I_N = 50-IN (motor rated current)
COS = 51-COS (cos ϕ)

The correction factor can either be entered or calculated from the inverter. Calculation starts when 49-SC = 1 and 54-KSC = 0.

The synchronous speed for the calculation is determined from the rated frequency 43-FN1. The calculated value is automatically stored under 54-KSC.

55-ISEL Current Regulation Selector [Decimal]

The current regulation selector determines the type of current limit value regulation. The control value is the phase apparent current 14-IS.

55-ISEL	Function
0	Current limit value control inactive
1	Acceleration/braking ramp current control, return to ramp function at $I > 125$ ILIM
2	Acceleration/braking ramp current control, ramp stop at $I > 125\%$ ILIM
3	Current injection*
4	As 1 but with current injection*
5	As 2 but with current injection*

*Further details upon request.

Current controlled acceleration (55-ISEL = 1)

After the inverter starts, the motor is accelerated with 32-RACC1. Acceleration reduces on reaching the current limit 75% of 56-ILIM. If the phase current 14-IS continues increasing and exceeds 100% of 56-ILIM, the motor is not accelerated any further. If the current limit 125% of 56-ILIM is exceeded the rotating field frequency set with FSIN is reduced to the minimum reduction frequency 57-FILIM using ramp 58-RILIM. As the phase current reduces below 100% of 56-ILIM, the inverter accelerates the motor again using ramp 32-RACC1 and the same applies in the case of braking (See diagram).

Current controlled acceleration (55-ISEL = 2)

Function as above but with the following difference:
After exceeding the current limit 125% of 56 ILIM the ramp 32-RACC1 does not accelerate any further. There is no reduction in frequency.

Current controlled acceleration (55-ISEL = 3/4/5)

Further information is available on request.

Diagram to show current controlled acceleration.

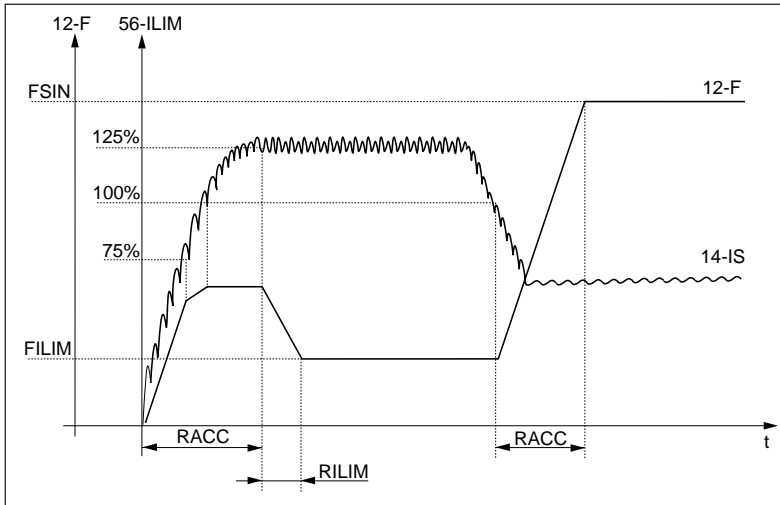

56-ILIM Current limit value [A]

See 55-ISEL and diagram

57-FILIM Minimum reduction frequency for current control [Hz]

See 55-ISEL and diagram.

58-RILIM Ramp for current control [Hz/s]

See 55-ISEL and diagram.

59-ITRIP I * t Monitoring (Motor) Trigger Current [A]

Parameter 59-ITRIP sets the I * t trigger current. When this current is exceeded, switch off occurs after a pre-set triggering time (see diagram) with error message E_OLM.

Motor Protection

The setting of the I * t triggering current must correspond with the rated current of the motor. This ensures that lower power motors than the rated equipment are also adequately protected against overload.

Quite apart from parameter 59-ITRIP the inverter has an I * t monitoring (device) which corresponds to setting to 59-ITRIP = device rated current and switching off with error message E_OLI.

Factory setting:

59-ITRIP = I_N (device rated current)

Diagram:

Line A = VF1445L, Line B = all other inverter types.

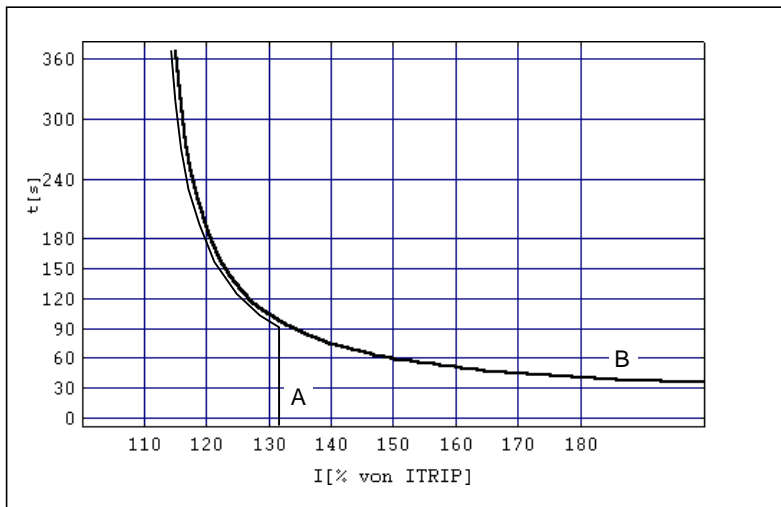

6.7 Signal Outputs

61-SOUTA Analog/Frequency Output

61-SOUTA	Function
0/2/7/ 8/10/11	No function, output SOUTA, SOUTF = 0
1 WE	SOUTA = 0...10V => FMIN...FMAX proportional output frequency, FOUTF = 0
3	SOUTF = 6 x the output frequency, SOUTA = 0
4	SOUTA = 0...10 V => apparent current scaled to 100% device rated current, SOUTF= 0
5	SOUTA = 0...10 V => effective current scaled to 100% device rated current, SOUTF= 0
6	SOUTA = 0...10 V =>effective power scaled to 100% device rated power, SOUTF = 0
9	SOUTA as 61-SOUTA= 1, SOUTF as 61-SOUTA= 3
12	SOUTA as 61-SOUTA= 4, SOUTF as 61-SOUTA= 3
13	SOUTA as 61-SOUTA= 5, SOUTF as 61-SOUTA= 3
14	SOUTA as 61-SOUTA= 6, SOUTF as 61-SOUTA= 3

62-S1OUT Programmable control output S1OUT [Decimal]

63-S2OUT Programmable control output S2OUT [Decimal]

64-S3OUT Programmable control output S3OUT [Decimal]

6_-S_OUT	Function (62-S1OUT,63-S2OUT,64-S3OUT)
0,9	No function, output S_OUT = 0
1	Active as soon as the inverter is connected to the main power supply an there are no errors
2	Active as long as the motor is excited
3	Active as long as counterclockwise > 0 or DC-hold active
4	Active as long as clockwise >0 or DC-hold active
5	Active as long as rotating field frequency 12-F = 0
6	Active as soon as the reference value is achieved
7	Active when rotating field frequency 12-F > 25-FF5
8	Active when apparent current 14-IS > 110% 59-TRIP current limit reached
10	Active after switch off on error

Factory setting: 62-S1OUT ->1, 63-S2OUT -> 7, 64-S3OUT -> 7

6.8 Program Functions

67-FST Filter Time Constants [Decimal]

This determines the filter time constants for analog reference value input FSIN (see also 04-FSSEL). Time characteristics as PT-element (low pass).

67-FST	Function
0	0 ms
1	8,2 ms
2	24,6 ms, factory setting
3	57,4 ms
4	123 ms

69-KOUTA Factor for Analog Output 61-SOUTA [Decimal]

This parameter is used for scaling the analog output SOUTA.

The voltage of an analog signal output is multiplied by the factor 69-KOUTA and limited to 10V in accordance with programming of 61-SOUTA.

On output of a PWM signal the pulse duty factor output is multiplied by the factor 69-KOUDA and limited to 100% in accordance with the 61-SOUTA programming.

71-PROG Special Programs [Decimal]

71-PROG is used for activating special programs. Special programs currently available:

71-PROG	Function
0	No special program active
1	Reset to factory setting (after entering 71-PROG=0)
2	Changed allocation of control terminals STR = 0 -> clockwise, STL = 1 -> START STR = 1 -> counterclockwise, STL = 0 -> STOP

72-START Start Options [Decimal]

72-START	Funktion
0	No start option active, factory setting
1	Auto start after power on with STL or STR bridged
2	Synchronisation to running motor
3	Auto start and synchronisation
4	Direction block: counterclockwise blocked
5	Direction block and auto start
6	Direction block and synchronisation
7	Auto start, synchronisation and direction block

Auto start 72-START = 1

If one of the start contacts STL or STR is bridged and the reference value input FSIN > 0,5 Hz, the inverter starts automatically when the main supply is restored.

Synchronisation 72-START = 2

After activating the start contact, the inverter first searches for the current motor speed. It starts by searching for maximum frequency 22-FMAX1 which means that the inverter is running faster than synchronisation speed. This causes a positive effective current to flow. The rotating field frequency is reduced until the effective current becomes negative so that the inverter is running at below synchronised speed. In this way the inverter synchronises to the motor speed found with the appropriate rotating field frequency. Synchronisation functions in both directions.

Direction Block 72-START = 4

This start option blocks counterclockwise rotation of the inverter absolutely. In this case counterclockwise can be activated neither using control input STL nor from the CTRL-menu.

74-PWM Switching frequency [decimal]

The parameter 74-PWM determines the switching frequency of the final stages. The inverter output current must be reduced if the switching frequencies > factory setting.

74-PWM	Switching freq.	Phase current 100%	Equipment
2*	7,8 kHz	6,2 A	VF1207L
3	15,6 kHz	6,2 A	
2*	7,8 kHz	9,5 A	VF1209L
3	15,6 kHz	8,5 A	
2*	7,8 kHz	3,8 A	VF1404L
3	15,6 kHz	3,8 A	
2*	7,8 kHz	5,6 A	VF1406L
3	15,6 kHz	5,6 A	
2*	7,8 kHz	7,2 A	VF1408L
3	15,6 kHz	7,2 A	
2*	7,8 kHz	8,9 A	VF1410L
3	15,6 kHz	7,2 A	
2*	7,8 kHz	12,5 A	VF1414L
3	15,6 kHz	7,2 A	
2*	7,8 kHz	16,5 A	VF1418L
3	15,6 kHz	11,3 A	
1*	3,9 kHz	23,0 A	VF1424L
2	7,8 kHz	23,0 A	
3	15,6 kHz	15,6 A	
1*	3,9 kHz	30,0 A	VF1432L
2	7,8 kHz	25,4 A	
3	15,6 kHz	15,4 A	
0*	1,9 kHz	43,5 A	VF1445L
1	3,9 kHz	33,5 A	

Continuous 10% phase current is permitted.

* Factory setting

86-KG Scaling Factor for 10-G

The factor determines the value of the display parameter 10-G in accordance with the formula:

$$(10-G) = (12-F) * (86-KG)$$

87-DISP Continuous Display [Decimal]

87-DISP determines the parameter for continuous display. All parameters on the VAL menu are possible.

88-PSW1 Password 1 [Decimal]

Determines the password for parametering <PARA> menu

89-PSW2 Password 2 [Decimal]

89-PSW2 determines the password for control from the KEYPAD CTRL menu.

91-TYPE Inverter Type [Decimal]

91-TYPE returns the type of the final stage which has been recognised. All the MIN and MAX values and factory settings of the voltage and current values which are given as absolute values depend upon this parameter. e.g. VF1209L - 44-VN1 = 220 V Factory Setting
 VF1406L - 44-VN1 = 380 V Factory Setting

92-REV Software Version [Decimal]

This returns the software version in use (see page 2).

94-MAXF Absolute Maximum Frequency [Hz]

This is the maximum frequency which the inverter can produce. The parameter is used for setting frequency reference values, current limit value regulation, slip compensation and synchronisation to a running motor. If this parameter is set to 0 the limit is switched off.

95-ERR1 Error 1 [Decimal 0.1s]

Stores the latest error message number - error - time (after each reset, max. 1.5 hours). Possible error messages:

Number	Meaning
1-1.5	Error in processor
2-1.5	Undervoltage (no entry in 95-ERR1 ÷ 98-ERR4)
3-1.5	Overcurrent, short circuit or short circuit to ground after power on
4-1.5	Overvoltage
5-1.5	I * t motor
6-1.5	I * t inverter
7-1.5	Overtemperature motor
8-1.5	Overtemperature inverter
9-1.5	Error in EEPROM

Acknowledge errors by pressing the start/enter key and holding it down for at least 3 seconds.

