



Switch Amplifier KHA6-SH-Ex1

- 1-channel isolated barrier
- 115/230 V AC supply
- Input for approved dry contacts or SN/S1N sensors
- Relay contact output
- Fault indication output
- Line fault detection (LFD)
- Up to SIL 3 acc. to IEC/EN 61508
- Up to PL d acc. to EN/ISO 13849

CE SIL3 PL d

Function

This isolated barrier is used for intrinsic safety applications. The device transfers digital signals (SN/S1N proximity sensors or approved dry contacts) from a hazardous area to a safe area. The input controls 1 relay contact output with 3 NO contacts (1 output is in series to the both output relays for the safety function), 1 relay contact output with 1 NO contact, and 1 passive transistor output (fault indication output). Unlike an SN/S1N series proximity sensor, a mechanical contact requires a 10 kΩ resistor to be placed across the contact in addition to a 1.5 kΩ resistor in series. Lead breakage (LB) and short circuit (SC) conditions of the control circuit are continuously monitored. During a fault condition, the fault indication output energizes and outputs I and II de-energize. For safety applications up to SIL 3, output I must be used. For safety applications up to SIL 2, output I and output II can be used.

Application

The input (terminals 10, 12) may generally be operated only with **potentially** free (passive) switches. Single channel operations up to SIL 3 **must** occur via terminals 13 and 14. The center tap of the contacts (terminals 19, 20) can **also** be used if an operation is to occur a redundant branch. If the device is used for safety operations the information in the test documents should be observed. The **fault message** output III delivers an 1-signal when the control circuit experiences lead breakage (LB) or a short circuit (LK). The device (housing type E) has integrated terminals.

Connection

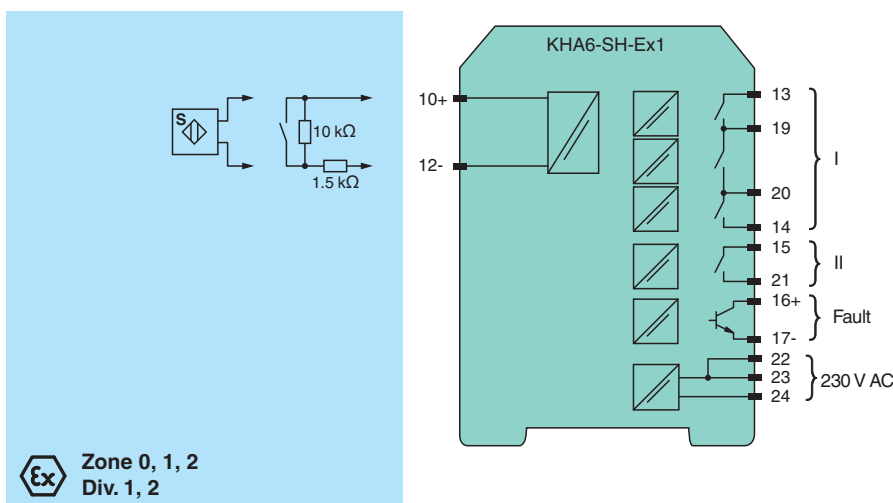

Technical Data

General specifications

Signal type Digital Input

Functional safety related parameters

Release date: 2023-06-01 Date of issue: 2023-06-01 Filename: 046904_eng.pdf

Refer to "General Notes Relating to Pepperl+Fuchs Product Information".

Pepperl+Fuchs Group
www.pepperl-fuchs.com

USA: +1 330 486 0002
pa-info@us.pepperl-fuchs.com

Germany: +49 621 776 2222
pa-info@de.pepperl-fuchs.com

Singapore: +65 6779 9091
pa-info@sg.pepperl-fuchs.com

 PEPPERL+FUCHS

Technical Data

| | | |
|--|-------|---|
| Safety Integrity Level (SIL) | | SIL 3 |
| Performance level (PL) | | PL d |
| Supply | | |
| Connection | | terminals 22, 23, 24 |
| Rated voltage | U_r | 85 ... 253 V AC , 45 ... 65 Hz |
| Rated current | I_r | 30 mA \pm 5 mA |
| Power dissipation | | 2.2 W |
| Power consumption | | max. 2.3 W |
| Input | | |
| Connection side | | field side |
| Connection | | terminals 10+, 12- |
| Open circuit voltage/short-circuit current | | approx. 8.4 V DC / approx. 11.7 mA |
| Lead resistance | | $\leq 50 \Omega$, in hazardous area cable capacitances and inductivities are to be taken into account |
| Switching point | | |
| Relay de-energized | | $I < 2.1 \text{ mA}$ and $I > 5.9 \text{ mA}$ |
| Relay energized | | $2.8 \text{ mA} < I < 5.3 \text{ mA}$ |
| Response delay | | $\leq 1 \text{ ms}$ |
| Output | | |
| Connection side | | control side |
| Connection | | output I: terminals 13, 14 ; output II: terminals 15, 21 ; output III: terminals 16+, 17- |
| Output I | | relay , signal |
| Contact loading | | 253 V AC/1 A/cos $\phi \geq 0.7$; 24 V DC/1 A resistive load |
| Mechanical life | | 50 x 10 ⁶ switching cycles |
| Output II | | relay , signal |
| Contact loading | | 253 V AC/1 A/cos $\phi \geq 0.7$; 24 V DC/1 A resistive load |
| Mechanical life | | 50 x 10 ⁶ switching cycles |
| Output III | | electronic output, passive , fault signal |
| Rated voltage | | 10 ... 30 V DC |
| Signal level | | 1-signal: (L+) -2.5 V (7 mA, short-circuit proof) / 0-signal: blocked output (Leakage current $\leq 10 \mu\text{A}$) |
| Transfer characteristics | | |
| Switching frequency | | 5 Hz |
| Indicators/settings | | |
| Display elements | | LEDs |
| Labeling | | space for labeling at the front |
| Directive conformity | | |
| Electromagnetic compatibility | | |
| Directive 2014/30/EU | | EN 61326-1:2013 (industrial locations) |
| Machinery Directive | | |
| Directive 2006/42/EC | | EN/ISO 13849-1:2015 |
| Conformity | | |
| Electromagnetic compatibility | | NE 21:2011 |
| Degree of protection | | IEC 60529:2001 |
| Safety | | IEC/EN 61508:2010 |
| Ambient conditions | | |
| Ambient temperature | | -20 ... 60 °C (-4 ... 140 °F) |
| Mechanical specifications | | |
| Degree of protection | | IP20 |
| Connection | | screw terminals |
| Mass | | approx. 280 g |
| Dimensions | | 40 x 93 x 115 mm (1.6 x 3.7 x 4.5 inch) (W x H x D) , housing type E |
| Mounting | | on 35 mm DIN mounting rail acc. to EN 60715:2001 |
| Data for application in connection with hazardous areas | | |

Release date: 2023-06-01 Date of issue: 2023-06-01 Filename: 046904_eng.pdf

Refer to "General Notes Relating to Pepperl+Fuchs Product Information".

Pepperl+Fuchs Group
www.pepperl-fuchs.com

USA: +1 330 486 0002
pa-info@us.pepperl-fuchs.com

Germany: +49 621 776 2222
pa-info@de.pepperl-fuchs.com

Singapore: +65 6779 9091
pa-info@sg.pepperl-fuchs.com

 PEPPERL+FUCHS

Technical Data

| | | | |
|---------------------------------|---|--|--|
| EU-type examination certificate | PTB 00 ATEX 2043 | | |
| Marking | | Ⓜ II (1)G [Ex ia Ga] IIC Ⓜ II (1)D [Ex ia Da] IIIC Ⓜ I (M1) [Ex ia Ma] I | |
| Input | Ex ia | | |
| Voltage | U _o | 9.56 V | |
| Current | I _o | 16.8 mA | |
| Power | P _o | 41 mW (linear characteristic) | |
| Supply | | | |
| Maximum safe voltage | U _m | 253 V AC/DC (Attention! The rated voltage can be lower.) | |
| Output | | | |
| Contact loading | 253 V AC/1 A/cos φ ≥ 0.7; 24 V DC/1 A resistive load | | |
| Maximum safe voltage | U _m | output I/output II: 253 V AC/DC (Attention! U _m is no rated voltage.) | |
| Galvanic isolation | | | |
| Input/Output | safe electrical isolation acc. to IEC/EN 60079-11, voltage peak value 375 V | | |
| Input/power supply | safe electrical isolation acc. to IEC/EN 60079-11, voltage peak value 375 V | | |
| Directive conformity | | | |
| Directive 2014/34/EU | EN IEC 60079-0:2018+AC:2020 , EN 60079-11:2012 | | |
| General information | | | |
| Supplementary information | Observe the certificates, declarations of conformity, instruction manuals, and manuals where applicable. For information see www.pepperl-fuchs.com . | | |

Assembly

Front view

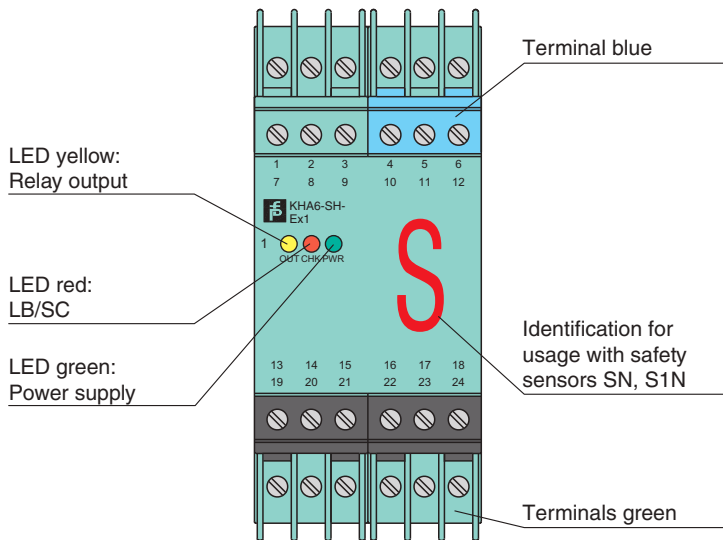



Release date: 2023-06-01 Date of issue: 2023-06-01 Filename: 046904_eng.pdf

Matching System Components

| | | |
|---|------------------|--|
|  | K-DUCT-BU | Profile rail, wiring comb field side, blue |
|---|------------------|--|

Refer to "General Notes Relating to Pepperl+Fuchs Product Information".

Accessories

| | | |
|---|------------------|--|
|  | KF-ST-5GN | Terminal block for KF modules, 3-pin screw terminal, green |
|  | KF-ST-5BU | Terminal block for KF modules, 3-pin screw terminal, blue |
|  | KF-CP | Red coding pins, packaging unit: 20 x 6 |

Characteristic Curve

Maximal switching power of the output

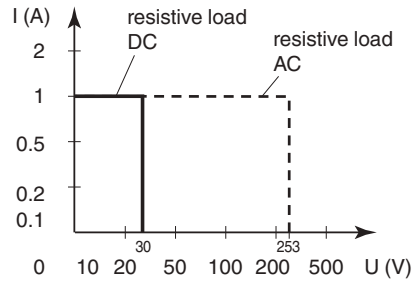

Release date: 2023-06-01 Date of issue: 2023-06-01 Filename: 046904_eng.pdf

Refer to "General Notes Relating to Pepperl+Fuchs Product Information".

Pepperl+Fuchs Group
www.pepperl-fuchs.com

USA: +1 330 486 0002
pa-info@us.pepperl-fuchs.com

Germany: +49 621 776 2222
pa-info@de.pepperl-fuchs.com

Singapore: +65 6779 9091
pa-info@sg.pepperl-fuchs.com