

RKC8T-5/TEL

Actuator and Sensor Cable, PVC – Connection Cable

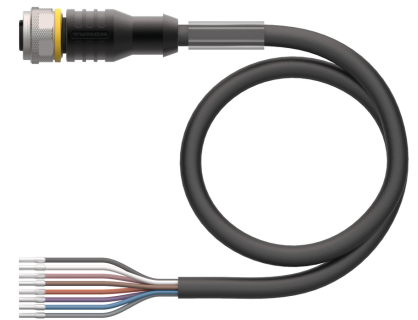
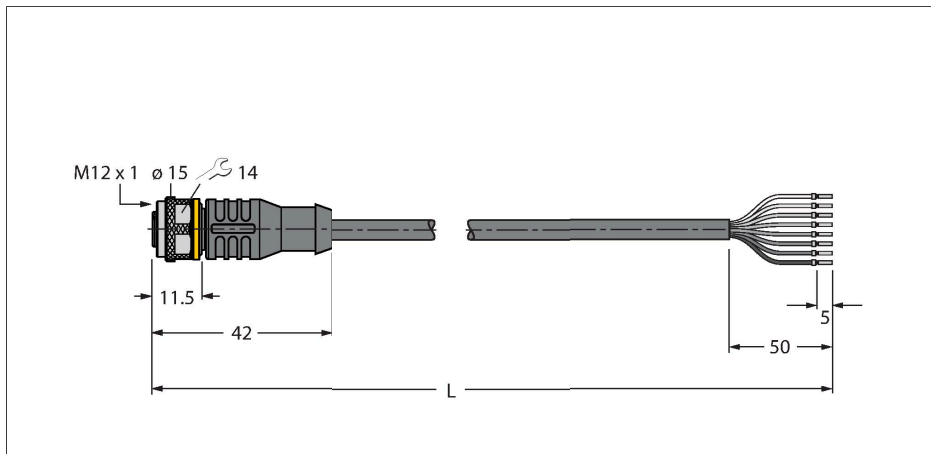

Technical data

Type	RKC8T-5/TEL
ID no.	6625131
Remark to product	Stranded wire colors and figure may differ.
Connector A	Female, M12 × 1, Straight, A-coded
Number of Pins	8
Contacts	Brass, CuZn, Gold-plated
Contact carriers	Plastic, TPU, Black
Connector body	Plastic, TPU, Black
Coupling nut/screw	Brass, CuZn, Nickel-plated
Seal	Plastic, FPM/FKM
Mechanical lifespan	> 100 Mating cycles
Pollution degree	3
Type of protection	IP67, IP69K, Only in screwed condition
Cable	
Cable diameter	Ø 5.7 mm ± 0.20
Cable length	5 m
Cable jacket	PVC, Black
Core insulation	PVC
Core cross-section	8 x 0.25 mm ²
Arrangement of strands	32 x 0.1 mm
Core colors	BN, WH, BU, BK, GY, PK, VT, OG
Electrical properties at +20 °C	
Rated voltage	30 V
Test voltage	2000 V
Current	2 A
Insulation resistance	> 30.5 MΩ/km
forward resistance	max. 79 Ω/km

Features



- Female M12, straight, 8-pin
- Jacket material: PVC
- Jacket color: black
- Resistant to chemicals and oils
- Flame-retardant
- Resistant to acids and alkaline solutions
- Resistant to microbes and hydrolysis
- LABS free
- Approval: cULus
- RoHS-compliant
- Protection class: IP67, IP69K
- Cable length: 5.0 m

Cable Cross-Section

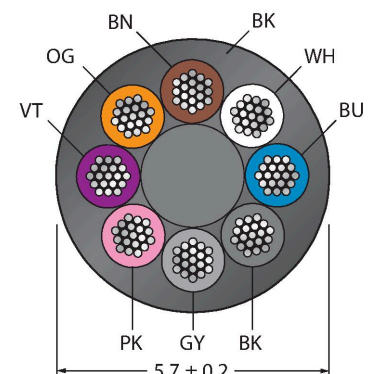

Contact assignment

Technical data

Mechanical and chemical properties

Bending radius (stationary installation)	≥ 5 x Ø
Bending radius (flexible use)	≥ 10 x Ø
Ambient temperature range (stationary)	-40 °C...+105 °C
Ambient temperature range (In motion)	0 °C...+80 °C

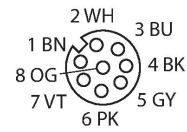

Circuit Diagram

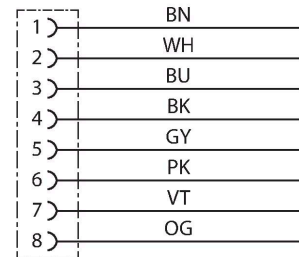

Stranded Wire Colors

Pin	DIN 47100 (old)	DIN EN 60947-5-2 (new)
1	WH	BN
2	BN	WH
3	GN	BU
4	YE	BK
5	GY	GY
6	PK	PK
7	BU	VT
8	RD	OG

Accessories

BS8181-0

6901004

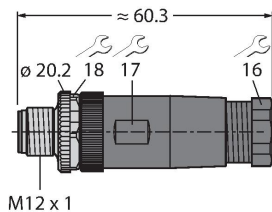

Field-wireable male connector, M12 × 1, straight, 8-pin, screw terminal connection, cable feedthrough 6.0 to 8.0 mm, core cross-section/terminal capacity 0.14 to 0.50 mm², plastic housing, metal retaining screw

BS8281-0

6930862

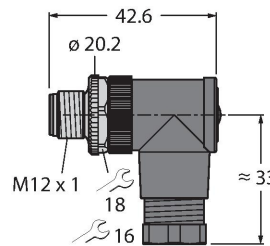

Field-wireable male connector, M12 × 1, angled, 8-pin, screw terminal connection, cable feedthrough 6.0 to 8.0 mm, core cross-section/terminal capacity 0.14 to 0.50 mm², plastic housing, metal retaining screw

CMBS8181-0

6930792

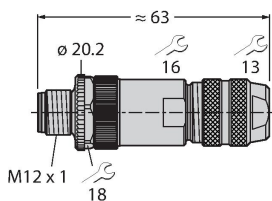

Field-wireable male connector, M12 × 1, straight, 8-pin, screw terminal connection, cable feedthrough 6.0 to 8.0 mm, core cross-section/terminal capacity 0.14 to 0.50 mm², metal housing, metal nut, shieldable, also for Ethernet

TORQUE-WRENCH-SET-AS

6936170



Torque wrench set; handles with adjustable torque 0.4-1.0 Nm, torque wrench for M8 (SW9), fork wrench for M12 (SW 14)

BLANK-LABEL-FOR-CORDSETS-TEL-TXL

6936206

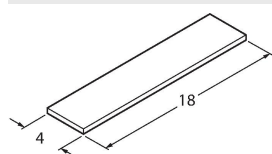

Label for TEL and TXL cables, length: 18 mm, height: 4 mm, material: polycarbonate (PC), color: white, halogen-free and flame-retardant