

Contents

TECHNICAL DESCRIPTION

1 Application	3
2 Technical data (acc. to VDI/VDE 2191)	3
3 Mode of operation	7
3.1 General principle of operation	7
3.2 Application circuits	8
3.3 Measuring circuit options	9
3.4 Internal reference junction compensation and plug-in lead balancing resistor	9
4 Construction	10
4.1 19" plug-in card	10
4.2 IP 20 surface-mounting case	11
4.3 IP 54 field enclosure	11

OPERATING INSTRUCTIONS

5 Mounting and connecting instructions	12
5.1 Mounting the instrument	12
5.2 Installing the measuring signal, output signal and power supply lines ...	13
6 Commissioning	13
6.1 Switching on the instrument.	13
7 Alarm signalling unit, sensor break signal contact	13
7.1 Setting the alarm value with relay or transistor output	13
8 Measuring circuit options	14
8.1 Measuring circuit break monitor	14
8.2 Strain gauge option, measuring circuit 395	14
9 Lead balancing	14
9.1 Lead balancing for two-wire circuit	15
9.2 Lead balancing for temperature difference measurement (measuring circuit 378)	15
9.3 Lead balancing for resistance teletransmitters.	15
10 Measuring range modification	15
10.1 General information	15
11 Test jacks	
12 Explosion-proof version	18
13 Trouble shooting	18
14 Maintenance	18
15 Packing instructions	18
16 Dimensional drawings (dimensions in mm)	19

Note

This apparatus has been designed and tested in accordance with DIN VDE 0411 Part 1 "Safety Requirements for Electronic Measuring Apparatus", and has been supplied in a safe condition. The information and warnings given below must be followed by the user to ensure safe operation and to retain the apparatus in a safe condition.

- Before any other connection is made, the protective ground terminal shall be connected to a protective conductor.
- Before switching on the apparatus make sure it is set to the voltage of the power supply.
- Any interruption of the protective conductor inside or outside the apparatus or disconnection of the protective ground terminal is likely to make the apparatus dangerous. Intentional interruption is prohibited
- When the apparatus is connected to its supply, terminals may be live, and the opening of covers or removal of parts (including those to which access can be gained by hand) is likely to expose live parts.
- The apparatus shall be disconnected from all voltage sources before it is opened for any adjustment, replacement, maintenance or repair.
- Any adjustment, maintenance and repair of the opened apparatus under voltage shall be avoided as far as possible and, if inevitable, shall be carried out by a person who is aware of the hazard involved.
- Capacitors inside the apparatus may still be charged even if the apparatus has been disconnected from all voltage sources.
- Make sure that only fuses with the required rated current and of the specified type are used for replacement. The use of rewired fuses and short-circuiting the fuse-holder is prohibited.
- Whenever it is likely that the protection has been impaired, the apparatus shall be made inoperative and be secured against any unintended operation.

According to the regulation DIN VDE 0411 an interruption in all poles of the power supply lines has to be provided. This interruption can also be provided for a group of instruments if the installation has the required voltage and current carrying capacity.

Subject to technical changes.

Reprint, reproduction or translation of this Manual or parts thereof are not permitted without our prior consent.

TECHNICAL DESCRIPTION

1 Application

Transmitters TEU 315 and TEU 325 are used for temperature measurement with thermocouples or resistance thermometers and for detecting measured variables that can be ascribed to a current, voltage or resistance change. The output signal delivered by the transmitters is a load-independent direct current or direct voltage, optionally with linearization of the primary detector characteristic. The transmitters are matched to the different types of measurement and spans by means of plug-in, interchangeable range units.

2 Technical data (acc. to VDI/VDE 2191)

Input

Separate technical data for the types

	TEU 315 TEU 315-Ex.A-C	TEU 325 TEU 325-Ex.A-C
Span from mV	1 mV	20 mV
Ω	(Pt 100) 3.2 Ω linear with resistance or temperature Pt 100 IEC	(Pt 100) 10 Ω
Ω	(Teletransmitter) 10 Ω	(Teletransmitter) 30 Ω
mA	5 μA	100 μA

Spans See limit settings

Measuring circuit 351, 352, 353

Permitted source or line resistance

up to 1 kΩ/mV without balancing With thermocouple break monitoring max. 700 Ω	up to 5 Ω/mV
---	--------------

Input resistance

1 MΩ/mV	2 kΩ/mV
Measuring circuit 395 Supply voltage 4 V ± 0.12% max. 11 mA	
Strain gauge nominal resistance 350 Ω or more	

Other measuring circuits see "Common technical data"

Common technical data

Permitted source or line resistance

Measuring circuit 371, 372	In two-wire circuit lead balancing necessary, in four-wire circuit no balancing (max. line resistance 100 Ω per wire)
Measuring circuit 373, 374	Up to 10 Ω per wire without balancing (equal resistance of lead wires required)
Measuring circuit 378	Balancing of line resistance necessary
Measuring circuit 381	> 1000 x input resistance

Measuring circuit 391	Lead balancing necessary
Measuring circuit 355	Up to 5 Ω/V without balancing
Measuring circuit 365	Up to 500 Ω without balancing
Measuring circuit 395	Up to 30 Ω per wire without balancing (equal resistance of lead wires balancing)

Input resistance

For current measurement	Up to 0.34 mA = 1087 Ω
Measuring circuit 381	0.34 ... 4.0 mA = 87.6 Ω 4.0 ... 100 mA = 5.6 Ω

For current measurement in summation or differentiation circuit

$$\text{Measuring circuit 382 Input resistance} = \frac{700 \text{ mV}}{I_{1,2}}$$

For voltage measurement with voltage divider

Measuring circuit 355	> 4 kΩ/V
Measuring circuit 365	100 kΩ

Overload limit with intrinsically safe measuring circuit note type test certificate

Voltage -3.5 ... +7 V for measuring circuits 351, 352, 353, 140% for measuring circuit 355 250 V (rms) for measuring circuit 365

Resistance, voltage Open or short-circuited input permitted

Current 1 : 10 for < 5 mA, 1 : 4 for ≤ 50 mA
1 : 2 ≥ 50 mA

Range units

Interchangeable range units with adjustable span (optionally with built-in linearization); rebalancing required after exchange; this does not apply to TEU 315, TEU 315-Ex if the range units are labelled "with basic adjustment". In transmitters with input test jacks with test/measure selector switch (Suppl. No. 450) an interchange is only possible within the following measuring circuits:

351	355	371 - 2 wire	371 - 4 wire	381
352	365	372 - 2 wire	372 - 4 wire	
353		373		
		374		
		391		

Half tolerance (Suppl. No. 430) is cancelled by the interchange.

Adjustment limits

(Note smallest span for TEU 325!)

	Output signal	
	0 ... 5/10/20 mA, ± 10 mA	4 ... 20 mA
	20 ... 0 mA, 0 ... 10 V	20 ... 4 mA
Meas. circuit 351, 353		
Span	1 ... 165 mV	1 ... 135 mV
Start of range	-75 ... 150 mV	-45 ... 150 mV
Measuring circuit 355		
Span	0.15 ... +150 V	0.15 ... 150 V
with test jacks	0.15 ... +60 V	0.15 ... 60 V
		Span ≥ 2
		Zero point
		with TEU 3.5-Ex max. 7.5 V
Start of range	-100 ... +100 V	-80 ... +100 V

Output signal

0...5/10/20 mA, ± 10 mA	4...20 mA
20...0 mA, 0...10 V	20...4 mA

Measuring circuit 365

Span	5...125 V (eff.)	5...125 V (eff.)
with test jacks	0.15...+60 V	0.15...60 V
	with TEU 3.5-Ex max. 5.5 V (eff.)	

Start of range	≤ 0.8 x final value	≤ 0.8 x final value
----------------	---------------------	---------------------

Measuring circuit 371, 372^{1) 2)}

Span	3...250 Ω	3...250 Ω
Start of range	30...320 Ω	80...320 Ω

Measuring circuit 373, 374^{1) 2)}

Span	10...250 Ω	10...250 Ω
Start of range	20...315 Ω	78...315 Ω

Measuring circuit 378

Span	3...250 Ω	3...250 Ω
Start of range	R _{T1} = R _{T2}	R _{T1} = R _{T2}

Measuring circuit 381

Span 1	≥ 5 μA ... < 0.34 mA	≥ 5 μA ... < 0.34 mA
Start of range 1	-0.18 ... +0.18 mA	-0.05 ... +0.18 mA
Span 2	≥ 0.34 mA ... < 4 mA	≥ 0.34 mA ... < 4 mA
Start of range 2	-2.2 mA ... +2.2 mA	-0.6 mA ... +2.2 mA
Span 3	≥ 4 mA ... ≤ 100 mA	≥ 4 mA ... ≤ 100 mA
Start of range 3	-35 mA ... +35 mA	-10 mA ... +35 mA

Measuring circuit 391

Span	10...2000 Ω	10...2000 Ω
Start of range	0...1000 Ω	0...1000 Ω

Measuring circuit 382 Δ I ≥ 200 μA

Measuring circuit 395

Span	1...229 mV	0.82...184 mV
Start of range	-75...+150 mV	-45...+150 mV

Measuring circuit options

Thermocouple break monitor

Permitted measuring circuit capacitance	0...200 nF	0...200 nF
---	------------	------------

Note type test certificate for Ex-version!

Permitted measuring circuit resistance	0...700 Ω	0...600 Ω
--	-----------	-----------

Output signal direct or reverse action

Break signal contact or alarm signalling unit

	Relay with change-over contact	normally open contact	Transistor (Optocoupler)
Max. switching power	3 W	10 W, L/R ≤ 50 ms	
Max. switching current	150 mA	10 VA, cos φ ≥ 0.7	100 mA
Min. switching voltage	≤ 28 V-	≤ 220 V≈	18...30 V-

¹⁾ Use resistance-linear measuring circuit with spans < 10 Ω, as non-linearity < 0.15 %

²⁾ The measuring range is permanently set for measuring circuits 371.1, 372.1, 373.1, 374.1

Switching action either min. or max. (transferable). NO contact operation (transferable to NC contact operation). Switching point selectable with potentiometer.

Range of adjustment 0...100 % (potentiometer limit stop at max. 110 %). Switching hysteresis 0.5 %.

Relay output or transistor output	Measured signal		Signal circuit as
	below alarm value	above alarm value	
In NC circuit	1	0	Closed circuit, current max. = open circuit current min.
In NO circuit	0	1	Closed circuit, current min. = open circuit current max.

1 = Contact closed (relay energized) or transistor switch conducting
0 = contact open (relay not energized) or transistor switch blocking

Output

Signal-range	with electrical isolation		without electrical isolation		
	without test jacks	with test jacks	without test jacks	with test jacks	Output EEx ib without test jacks
0...20 mA 4...20 mA	0...750 Ω or 0...600 Ω u. 0...50 Ω	0...700 Ω or 0...550 Ω u. 0...50 Ω	0...500 Ω or 0...350 Ω u. 0...50 Ω	0...450 Ω or 0...300 Ω u. 0...50 Ω	0...300 Ω or 0...150 Ω u. 0...50 Ω
-10...0... +10 mA	0...750 Ω or 0...450 Ω u. 0...100 Ω	0...650 Ω or 0...350 Ω u. 0...100 Ω	-	-	-
0...5 mA	0...3 kΩ or 0...2.4 kΩ u. 200 Ω	0...2.8 kΩ or 0...2.2 kΩ u. 200 Ω	-	-	-
0...10 mA	0...1.5 kΩ or 0...1.2 kΩ u. 0...100 Ω	0...1.4 kΩ or 0...1.1 kΩ u. 0...100 Ω	-	-	-
0...10 V	> 2 kΩ	> 2 kΩ	-	-	-

Open output permitted

Ripple content of output variable < 0.5 % (peak-to-peak) without input interference voltage with span > 5 mV, > 3.2 Ω, > 5 μA
< 1% with span < 5 mV

Ripple content in measuring circuit 365 with filter 1 with filter 2
f = 5 Hz : 0.5 % f = 20 Hz : 0.5 %
10 Hz : 0.2 % 30 Hz : 0.2 %
≥ 35 Hz : 0.1 % ≥ 50 Hz : 0.1 %

Limitation of output current Approx. 27 mA
(approx. 32 mA in TEU 3.5-Ex.C)
min. 2 mA for output 4...20 mA
(Suppl. No.480)

Power supply

(See rating plate for rated voltages)

Alternating voltage	-15 %...+10 %
Frequency	48...62 Hz
Direct voltage	± 25 % With 24 V DC 18...33 V With 24 V AC/DC 19.2...33 V
Residual ripple	≤ 20 % within the tolerance range

Power consumption			Fuses		
Power supply	Alarm signalling		Power supply fuse 1	Only for TEU 3.5-Ex	
	With	without		fuse 4	fuse 3
24 V~	3.0 W	2.7 W	M 0.315 C	T 100 mA	M 32 C*)
24 V-	2.8 W	2.5 W	M 0.315 C	T 100 mA	M 32 C*)
48 V-	2.7 W	2.4 W	M 0.16 C	-	-
60 V-	2.7 W	2.4 W	M 0.16 C	-	-
110 V-	2.6 W	2.3 W	M 0.08 C	-	-
220 V-	2.8 W	2.5 W	M 0.05 C	-	-
110 V~	2.8 W	2.5 W	M 0.08 C*)	T 100 mA	M 32 C*)
127 V~	2.7 W	2.4 W	M 0.08 C*)	T 100 mA	M 32 C*)
220 V~	3.1 W	2.8 W	M 0.05 C*)	T 100 mA	M 32 C*)
230 V~	3.3 W	3.0 W	M 0.05 C*)	-	-

Transmitters with measuring circuit 395 (strain gauge measurement) have 0.3 W greater power consumption.

Required connection performance of power supply source

$P_{\text{effectice}} = 1.5 \times \text{value of power consumption, current drain not sinusoidal}$

*) For Ex-version: only fuses with fuse-elements provided with a winding are tolerated.

Environmental capabilities

Construction	19" plug-in card	Surface mounting case IP 20	Field enclosure IP 54
Application class to DIN 40 040	J5F	JVF	HVD
Ambient temperature	-10 ... +70 °C ¹⁾	-10 ... +55 °C	-25 ... +55 °C
Transportation and storage temperature		-30 ... +80 °C	
Relative humidity, annual average	≤ 75 %	≤ 75 %	≤ 80 %
Condensation	None	None	Tolerated

Mechanical capabilities

Tests to DIN IEC 68, Part 2-6, Part 2-27

In operation

Shock 30g/11 ms
Oscillation 2.5g/± 0.16 mm / 5 ... 150 Hz

Seismic stress class II to DIN 40 046 Part 55

Oscillation 2g/± 10 mm/5 ... 35 Hz

¹⁾ Max. +60 °C (application class JUF) for TEU 3.5-Ex with 110/127/220 V AC power supply, for ambient temperature permitted for equipped 19" sub-rack see page 12.

²⁾ Incremental error with internal reference junction compensation 0.5 K for 19" plug-in module, 0.5 K for surface-mounting case, 1.0 K for field enclosure

³⁾ At points with total insulation at least the simple values of insulation group C are realized for creepage distances.

Case and mounting

Construction	19" plug-in card	IP 20 surface mounting case	IP 54 field enclosure
Electrical connections	32pole connector, to DIN 41612 type D or F	6.3 mm tab connectors or screw terminals for 2.5 mm ²	Screw terminals for 2.5 mm ²
Degree of protection to DIN 40 050	IP 00		IP 54
Connection Screw terminals Tab connectors		IP 20 IP 00 (IP 20 via insulating sleeves)	
Class of protection to VDE 0411 IEC 348, not Ex-version	I	II	II
Ex-version	I	I	
Insulation group to VDE 0110	C ³⁾	C ³⁾	C ³⁾
Color	RAL 7032	RAL 7032	RAL 7032
Oper. orientation	Handle at top or bottom Front panel vertical		Cable glands underneath
Weight	Apr. 0.6 kg	Apr. 1.0 kg	Apr. 2.0 kg

after installation in 19" sub-rack. Connection of a functional earthing is necessary for radio interference suppression. The measuring circuits are then insulated according to class of protection II.

With protective conductor connection

Test voltage to VDE 0411 Mains with respect to input/output 3kV. For version with electrical signal isolation, input with respect to output 3 kV, for test jacks 0.75 kV, for Ex.A and Ex.B 3 kV.

Unsolder capacitors (see Fig. 7, Pos. 11) or disconnect earth connection (see Fig. 5, Pos. 8) during voltage tests.

Characteristics at equilibrium under nominal conditions

Basic shape of characteristic

Linear

Terminal-based conformity

Error limit <± 0.5%²⁾ referred to output span, half tolerated as "option" <± 1% with spans < 5 mV, < 7 Ω or < 25 μA

Non-linearity

Contained in non-linearity.

Alarm value deviation:

Measuring circuit 352.1 ... 3: < 0.3% not available with "half-tolerance" for start of range < 300 °C

< 0.5% for type S

< 1% for type R

352.4: error depends on shape of curve

365: < 0.2%

378, 395: < 0.3%

372, 374: < 0.2% for temp.

> 0 °C

All other measuring circuits < 0.1%

Static error

< 0.1%, referred to output span

Nominal conditions

Ambient temperature	18 ... 28 °C
Tolerated temperature fluctuation during measurement	2 K
Power supply	Voltage $\pm 2\%$ Harmonic content $\leq 5\%$ Rated frequency $\pm 0.5\%$ No harmonics with direct voltage supply
Load	For I_A : $R_{A \max}$ For U_A : $R_{A \min}$
Warm-up time	≥ 30 minutes

Characteristics at equilibrium in the event of deviation from the nominal conditions

Effect of ambient temperature	$\leq 0.2\%/10$ K on zero $\leq 0.1\%/10$ K on span	} referred to output span
	Incremental error with built-in reference junction compensation approx. 0.5 °C/10 K, with Pt 100 IEC for spans < 50 K 0.05 °C/10 K	

Effect of power supply	$< 0.1\%/10\%$ voltage fluctuation $< 0.1\%$ with 48 ... 62 Hz frequency fluctuation
------------------------	---

Effects at input

Effect of interference voltage of 50 Hz balanced-mode alternating interference voltage	$< 0.1\%$ at 3 x span, increased residual ripple
50 Hz unbalanced alternating interference voltage	$< 0.1\%$ up to max. 250 V_{rms} (eff.)
unbalanced direct interference	$< 0.1\%$ up to max. 250 V

Effects at output

Effect of load on current output	$< 0.05\%$ within load range
on voltage output	$< 0.5\%$ from 2 k Ω ... ∞
Effect of external voltage on current output	$< 0.1\%$ with $U_{ext} \leq 15$ V (7.5 V at output ± 10 mA, 10 V without electrical isolation)
Effect of interference voltage	$< 0.1\%$ per 250 V (with electrical isolation)

Time response (dynamic response)

Abrupt change from 10 to 90%, residual error $\pm 1\%$, aperiodic setting

	Electrical isolation			
	With		Without	
	Measuring ranges			
	1...5 mV	> 5 mV	1...5 mV	> 5 mV
Response time T_a	300 ms	200 ms	300 ms	200 ms
Recovery time after interruption of measuring circuit	10 s	6 s	70 s	12 s

Response time for Measuring circuit 365 with filter 1 < 8 s, with filter 2 < 0.7 s
Long time effect $< 0.2\%/year$

Explosion protection

Factory code	49/11-38 Ex
Type test certificate	PTB No. Ex-84/2123X

	Type key	
	With chopper amplifier from 1 mV	with differential amplifier from 20 mV
without expl. proof	TEU 315	TEU 325
Input EEx ia IIC	TEU 315-Ex.A	TEU 325-Ex.A
Input EEx ib IIC	TEU 315-Ex.B	TEU 325-Ex.B
Input and Output EEx ib IIC	TEU 315-Ex.C	TEU 325-Ex.C

Mounting outside the hazardous area

Ambient temperature	Up to $+70$ °C
Monitoring loop	Up to 220 V, up to 1 A
Type of protection of input circuit:	intrinsic safety EEx ia IIC or EEx ib IIC

Maximum transmitter values	Measuring circuit			
	371, 372 373, 374 378, 391	395	351, 352 353, 365	355, 381 382
U	19.5 V	19.5 V	19.5 V	19.5 V
I	72 mA	100 mA	40 mA	30 mA
P	0.4 W	0.6 W	0.2 W	0.15 W
L_i	0	0	0	0
C_i	5 nF	4 nF	5 nF	4 nF
Permitted L_a	5.5 mH	2.9 mH		
Permitted C_a	190 nF	191 nF		
Permitted L_a	1 mH	1 mH		
Permitted C_a	82 nF	66 nF		

Output circuit in type of protection EEx ib IIC for the connection of passive intrinsically safe circuits.
This circuit is electronically limited.

Maximum transmitter values	
U	10 V
I	50 mA
P	0.5 W
L _i	0
C _i	0
Permitted L _s	2 mH
Permitted C _s	350 nF

3 Mode of operation

3.1 General principle of operation

Transmitters TEU 315 and TEU 325 are suitable for direct and alternating voltage measurement, and for resistance and direct current measurement.

The input variable is converted into a load-independent direct current or direct voltage signal. Matching to the measured variable and the measuring range is accomplished by means of interchangeable measuring circuit options and range units with adjustable span. The basic version comprises the following modules:

Printed circuit board with switching regulator and rectifier (1), power supply unit (2), amplifier (3) and range unit (4). The following modules may be incorporated in addition:

Electrical isolating stage (6), output stage (7), measuring circuit option for sensor break monitoring or strain gauge bridge supply (8), sensor break signal contact (9) or alarm signalling unit (11) with relay output or transistor output. Explosion-proof transmitter versions (TEU 3.5-Ex.A and 3.5-Ex.B) are equipped with limitation (5) for the intrinsic safety of the input circuit and electrical electrical isolation (6).

Explosion-proof version TEU 3.5-Ex.C is intrinsically safe at the input and output and additionally has electronic current and voltage limitation in the output circuit. In this version there is no electrical isolation between input and output.

The input signal is passed via the range unit (4) to the amplifier (3), which delivers a load-independent DC signal. If electrical isolation (6) is built in, the DC signal is chopped, decoupled by an isolating transformer and reconverted to a load-independent direct current by a rectifier circuit with an impedance matching network. This signal is unipolar.

The output stage (7) is necessary for conversion to a bipolar current signal or a load-independent voltage. With the measuring circuit option (8) the amplifier is driven to the lower or upper range-value if the measuring circuit is interrupted. For resistance measurement in four-wire circuit the measuring circuit option also accommodates the impedance converter, which makes this circuit possible through its highly resistive input.

The sensor break signal contact (9) is driven by the measuring circuit option (8) and causes the relay contact to switch in the event of an interruption in the measuring circuit. The internal reference junction compensation (10) for thermocouples delivers a compensation voltage to the transmitter if the ambient temperature deviates from 20 °C. The power supply unit (2) provides the modules with the required voltages.

The alarm signalling unit (11) with relay output or transistor output has an adjustable switching point with NO or NC contact operation. In the 19" construction the alarm value is adjustable at the front panel. The switching status is indicated by an LED. Transmitters with an output that is linear with temperature have range units with built-in correction units. The transmitters may optionally be supplied with test jacks for input and/or output, and test/measure selector switches for input.

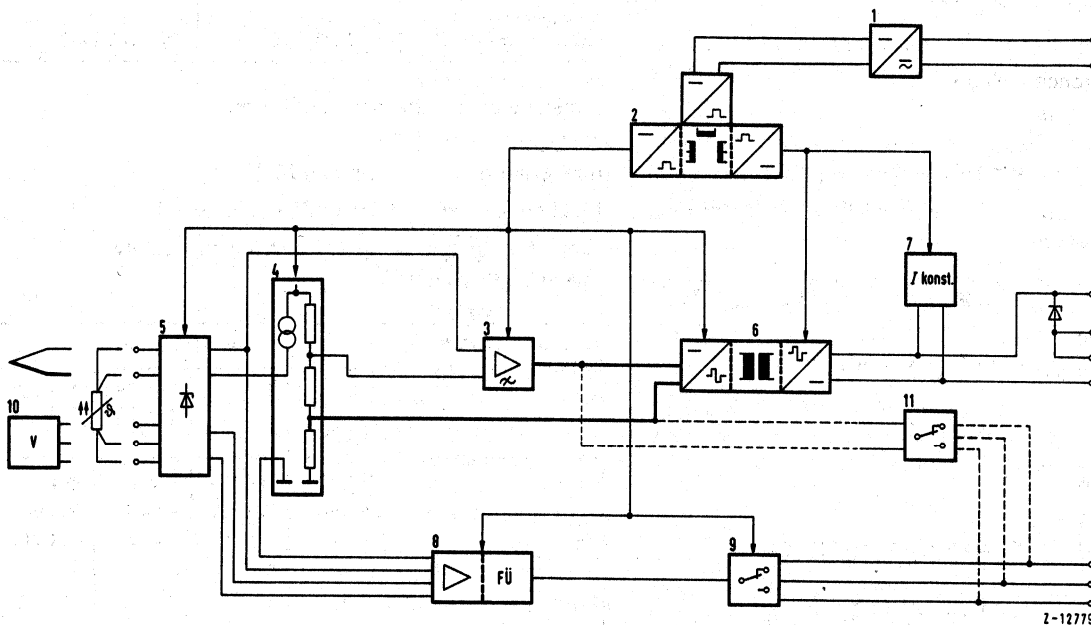

Fig. 1 Circuit diagram of a 4-wire transmitter

- | | |
|---|---|
| 1 Printed circuit board with switching regulator and rectifier | 7 Output stage for \pm output, voltage output or reverse action characteristic |
| 2 Power supply unit | 8 Measuring circuit option for sensor break monitor or strain gauge bridge supply |
| 3 Amplifier | 9 Sensor break signal contact |
| 4 Range unit | 10 Internal reference junction compensation |
| 5 Limitation | 11 Alarm signalling unit with relay or transistor output |
| 6 Electrical isolation or current limitation
Output EEx ib IIC in version TEU 3.5-Ex.C | |

3.2 Application circuits

Matching to type of measurement and span is accomplished with plug-in range units that are referred to by way of measuring circuit numbers. In principle all measuring circuits are interchangeable, it being necessary to note the following:

Types TEU 315, TEU 315-Ex are supplied with basic adjustment. The range unit is therefore labelled "with basic adjustment".

Basic adjustment is not available for types TEU 325, TEU 325-Ex.

In transmitters with input test jacks, range unit interchange is only permitted for the measuring circuits allocated in the table in Section 11.

For transmitters without basic adjustment, instrument and range unit are calibrated jointly in the factory. Readjustment is therefore necessary if the range unit is exchanged (see Section 10).

In TEU 315 transmitters and range units that are both labelled "with basic adjustment", the range units can be exchanged without recalibration. The error limit of $\pm 0.5\%$ is retained.

The range units are interchangeable and have an adjustable span (coarse with solder links, fine with potentiometers).

Measuring circuit 352 (thermocouple output signal linear with temperature) has a permanently adjusted range. The range can be set to smaller spans with two fixed resistors.

The output signal (0/4 ... 20 mA) is also defined by the range unit.

For a ± 10 mA bipolar current output, 0 ... 5 mA, 0 ... 10 mA, 20 ... 0 mA, 20 ... 4 mA output signal, or 0 ... 10 V voltage signal an additional module is required. The measuring range is changed in the same way as for the version with 0 ... 20 mA output signal.

Measuring circuits 351, 352, 353

Here direct voltages in the mV range are converted by the compensation method into an output signal proportional to the input value.

In measuring circuits 351, 353 the output variable is linear with voltage, in measuring circuit 352 it is linear with temperature.

Measuring circuit 352 is designed primarily for linearizing thermoelectric voltages.

Reference junction compensation may be accomplished internally with a plug-in module.

Measuring circuit 355

With this measuring circuit voltages between 150 mV and 150 V are reduced by a built-in voltage divider and converted by the amplifier into a standardized output signal.

Measuring circuit 365

This measuring circuit is designed to measure alternating voltages. The primary elements are rotational speed pick-ups or tachometer generators that generate voltages between 5 V (rms) and 125 V (rms)*) and lie in the frequency range 5 Hz to 1000 Hz.

The sinusoidal alternating voltage generated by the primary elements is reduced in the measuring circuit input by a built-in voltage divider and then passed to a circuit that forms the arithmetical rectifier value. After smoothing by an RC filter the resulting direct voltage is switched to the input of the measuring amplifier.

With measuring circuit 355 and 365 care must be taken that no current overloading occurs in the input current circuit; therefore an incoming current limitation, e.g. a fuse (< 2 A) is to be provided.

Measuring circuits 381, 382

In current measurement the input current to be measured is switched to a shunt and thereby reduced to a voltage measurement.

Measuring circuits 371, 372

These measuring circuits are designed for connection to Pt 100 IEC resistance thermometers in two and four-wire circuit. Whether the output current is proportional to the change in resistance or the change in temperature can be specified through the wiring (solder link). If a resistance thermometer is connected in **four-wire circuit, the four-wire impedance converter option is always** required in addition, with or without thermometer and wire break monitor.

Linearization (measuring circuit 372) is effected by a Pt 100 current dependent on the amplifier drive level. The current sent through the resistance thermometer is approx. 2.4 mA.

Measuring circuits 373, 374

Measuring circuits 373, 374 are provided for connecting Pt 100 IEC resistance thermometers in three-wire circuit. Here, too, it can be specified through the wiring whether the output current is proportional to the change in resistance or the change in temperature. Linearization (measuring circuit 374) is accomplished in the same way as for measuring circuit 372. The bridge supply current is approx. 2.4 mA.

Measuring circuit 378

Measuring circuit 378 is used for resistance difference measurement with two resistance thermometers. Each current-fed thermometer forms a "half bridge", the resistance difference being amplified and converted to a linearized output signal in the operating range.

Measuring circuit 391

Resistance teletransmitters are supplied with a constant current of approx. 0.76 mA or 0.3 mA. The measured voltage generated at the teletransmitter as a function of the position is picked up between the negative connection of the bridge circuit (ground) and the slider and converted to a proportional output signal. As only the negative lead (a4-11: teletransmitter start, see also connection diagram) produces a voltage drop, which falsifies the measurement result, a balancing resistor of 10 Ω (internal or external or balancing with a zero potentiometer) is required for this teletransmitter circuit. Due to the high internal resistance of measuring circuit 391 and the input amplifier, the resistance of wires c4-12 (teletransmitter pick-up) and a8-13 (teletransmitter end) is not incorporated in the measurement result.

Measuring circuit 395

This measuring circuit is used for measurement with a strain gauge in full bridge circuit. If the bridge is supplied with a constant voltage of 4 V, bridge imbalance gives rise to a usable signal which is amplified.

*) For intrinsically safe measuring circuit, note type test certificate.

3.3 Measuring circuit options

3.3.1 Thermocouple break monitor

In order to obtain a defined output signal in the event of interruption of the measuring leads or the thermocouple, a "thermocouple break monitor" can be built into the transmitter. This consists of an RC oscillator that oscillates with measuring circuit resistances $> 1000 \Omega$ and supplies a rectified voltage to the transmitter input. Depending on the polarity of the rectifier diode the transmitter output signal can be driven to the lower or upper range value (see Section 8). The break signal contact is also controlled by this measuring circuit option.

3.3.2 Two and three wire thermometer and wire break monitor

In order to obtain a defined output signal in the event of interruption of the resistance thermometer or measuring leads, a break monitor can be built into the transmitter. This consists of a threshold switch and an oscillator that operate if the voltage at the resistance thermometer increases to greater than 2 V due to an interruption (the maximum operating voltage is 1 V). The break signal contact is also controlled by this measuring circuit option.

The option is not required for the two-wire circuit if no thermometer break signal contact is built in and the transmitter is driven to the upper range value. In this case the transmitter overranges automatically as a result of thermometer break.

For the three-wire circuit the break monitor produces the desired transmitter drive level if one or more lead wires or the thermometer are interrupted. The break signal contact is also controlled by the measuring circuit option.

3.3.3 Four-wire impedance converter with and without thermometer and wire break monitor

This measuring circuit option is required if the thermometer is operated in four-wire circuit. The impedance converter enables high-resistance voltage pick-up at the thermometer. By means of the break monitor the amplifier is controlled in a defined way in the event of interruption of the thermometer or the 4 measuring leads. The break monitor is also required for driving the break signal contact.

3.4 Internal reference junction compensation and plug-in lead balancing resistor

3.4.1 Internal reference junction compensation

During measurements with thermocouples, reference junction compensation can be performed within the transmitter.

In the IP 54 field enclosure construction the compensation unit is inserted behind the terminal strip, in the IP 20 surface mounting case it is inserted in the case socket.

For the 19" plug-in card construction two versions are possible:

1. An additional mounting plate for fitting to the sub-rack. This plate has 2 terminals for connecting the extension lead wires, 3 blade-type terminals for the compensation unit and 5 solder points for the wiring between mounting plate and connector assembly of the 19" plug-in card. The maximum line resistance between reference junction compensation unit and transmitter is 1Ω per wire (see Fig. 3).
2. A cap for the female connector with built-in reference junction compensation (see Fig. 2).

The internal reference junction compensation is designed for 20°C and can be used for the different types of thermocouple (see Fig. 3).

3.4.2 Plug-in 10Ω lead balancing resistor

For resistance measurements in two-wire circuit, resistance difference measurements and with resistance teletransmitters a plug-in lead balancing resistor can be built into transmitters of IP 54 field enclosure construction. (In transmitters of 19" plug-in card and IP 20 surface-mounting case construction lead balancing must be accomplished with the zero potentiometer at the range unit or with an external lead resistor.)*

An external lead balancing unit for 19" plug-in cards can be delivered together with the cap for the female connector (see Fig. 2).

If the range unit has basic adjustment, it is cancelled by this. If lead balancing is necessary for measurements with resistance thermometer in three-wire circuit this must be effected externally.

For measurements with resistance thermometers in four-wire circuit lead balancing is not required; the line resistance per wire should not, however, exceed 100Ω .



Fig. 2 Cap IP 20 for female connector with reference junction compensation or lead balancing resistor (see Data Sheet 11-9.51 EN).



Fig. 3 Internal reference junction compensation (width 3E, E = 5.08 mm)

- 1 Reference junction compensation
- 2 Mounting plate for fitting to 19" sub-rack
- 3 Terminals for extension lead wire
- 4 Solder points for wiring

*) If balancing is effected with an internal or external lead balancing resistor, 10Ω must be calibrated into the start of range.

4 Construction

4.1 19" plug-in card

The 19" plug-in card (dimensions 100 mm x 160 mm) is fitted with a 32-pole blade connector. Except for the plug-in range units and the measuring circuit options the modules are soldered into the base board.

Fig. 4 shows the front panel of the 19" plug-in card and the arrangement of range unit, the manual control elements and the LED for the built-in alarm signalling unit. The potentiometers for fine adjustment of start of range and span are integrated into the range unit and are exchanged if changing the type of measurement. Test jacks for input with test selector switch/measure and test jacks for output or alarm signalling unit with adjustment potentiometer and LED are options that can be incorporated if ordered (at extra charge).

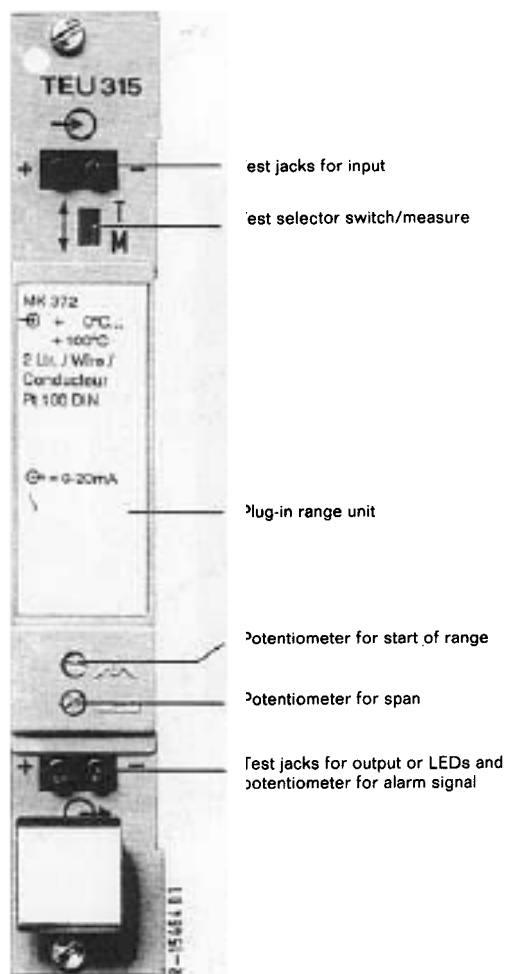

Fig. 4 Front panel of the 19" plug-in card

Fig. 5 shows the arrangement of modules on the base board. The disposal of the electronics on the base board is the same in all constructions.

The 19" plug-in card is provided with a plastic cover that together with the front panel forms a unit. On the cover is the rating plate and the coding comb for the different Ex versions of the 19" construction with blade connector type D. The mating part for this coding comb must be fitted to the associated slot on the 19" sub-rack (see Section 5.1.3.1).

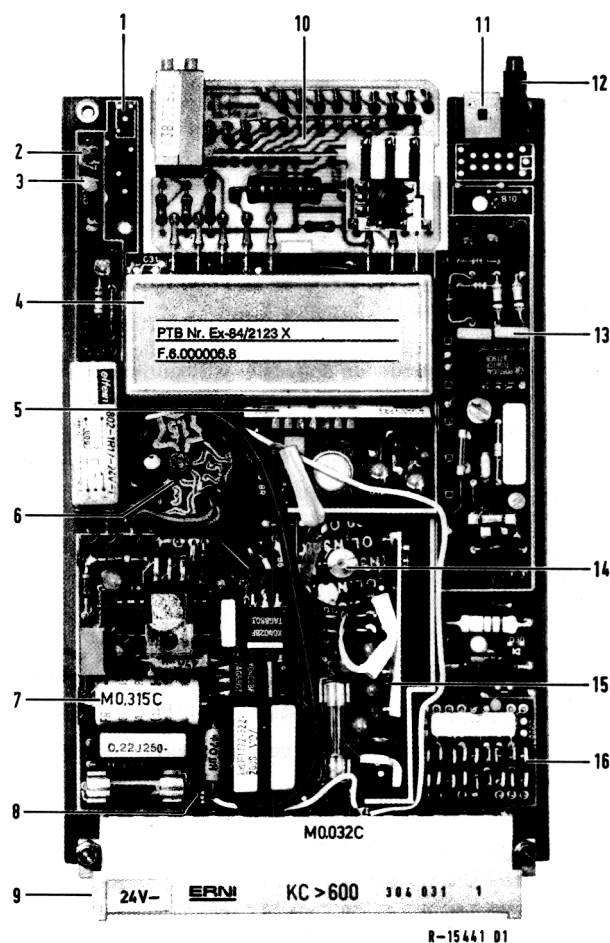

Fig. 5 Structure of the 19" plug-in card

- | | |
|--|---|
| 1 Test jacks for output or alarm signalling unit | 10 Plug-in range unit |
| 2 Alarm signalling unit | 11 Test switch/measure |
| 3 Sensor break signal contact | 12 Test jacks for input |
| 4 1 mV or 20 mV amplifier | 13 Sensor break monitor and/or impedance converter for four-wire circuit or measuring circuit option for strain gauge measurement |
| 5 15 V constant voltage source | 14 Electrical isolation |
| 6 Mains isolator | 15 Output stage for \pm output or voltage output or reverse action characteristic |
| 7 Ex limitation for power supply | 16 Ex limitation for input |
| 8 Ground terminal for Y capacitors | |
| 9 Blade connector type D or F | |

4.2 IP 20 surface-mounting case

Fig. 6 shows the 19" plug-in card in an IP 20 surface-mounting case.

A 19" plug-in card is inserted into the plastic case and fastened with 2 screws. All manual control elements and the range unit are accessible in the front panel. Blade-type terminals or screw terminals are attached on the bottom at the side for the electrical connections.

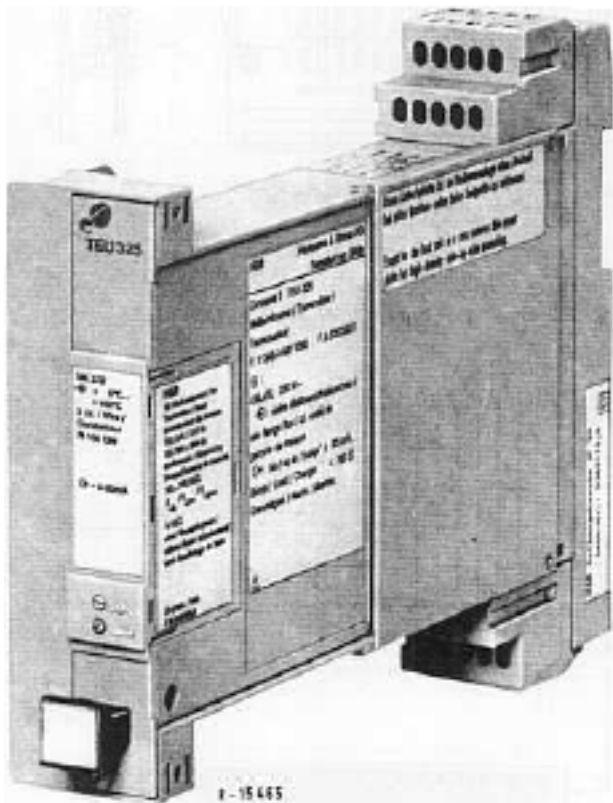

Fig. 6 19" plug-in card in an IP 20 surface-mounting case

4.3 IP 54 field enclosure

The transmitter housing protected to IP 54 (Fig. 7) for field installation is made of Terluran plastic and comprises the base and the cover (not illustrated).

Transmitter TEU 315/325 in the IP 54 enclosure contains a printed circuit board with the complete electronics and a terminal strip for the electrical connections that is soldered into the printed circuit board.

The circuit board is fastened into the enclosure base with 4 screws. With the cover removed, the range unit and the potentiometers for start of range, span and alarm signal are accessible.

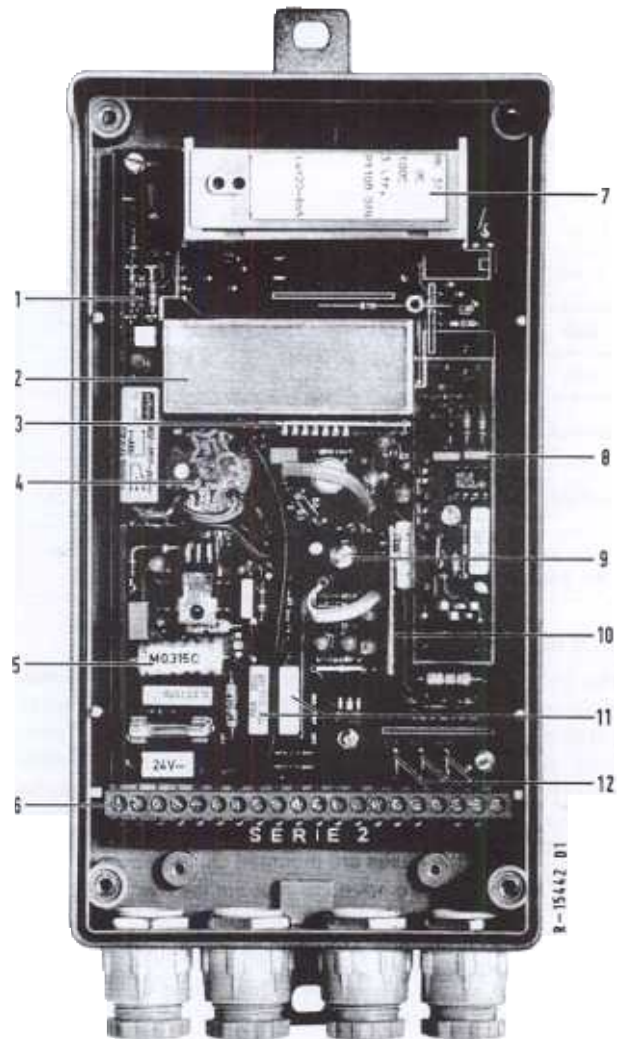

Fig. 7 Transmitter in surface-mounting case protected to IP 54

- 1 Alarm signalling unit or sensor break signal contact
- 2 1 mV or 20 mV amplifier
- 3 15 V constant voltage source
- 4 Mains isolator
- 5 Switching power supply
- 6 Terminal strip
- 7 Range unit
- 8 Sensor break monitor and/or impedance converter for four-wire circuit or measuring circuit option for strain gauge measurements
- 9 Electrical isolation
- 10 Output stage for 0...5 mA or 0...10 mA or 10 V or ± 10 mA or reverse action characteristic
- 11 Y Capacitors
- 12 Blade-type terminal for reference junction compensation

OPERATING INSTRUCTIONS

5 Mounting and connecting instructions

5.1 Mounting the instrument

5.1.1 19" plug-in card

Transmitter TEU 315/325 in the form of a 19" plug-in card is inserted in the slot provided in the 19" sub-rack and secured with 2 screws at the front panel. The signal and power supply lines must be routed to the appropriate female connector (mating connector) and there connected. The space occupied by a 19" plug-in card is $4E \pm 20$ mm so that up to 21 transmitters can be inserted into a 19" sub-rack. The connectors must be mounted in an appropriate distance.

Permitted ambient temperature of the equipped 19" sub-rack:

Explosion proof	Power supply	19" sub-rack equipped with	
		TEU 3.5 in 4E spacing	TEU 3.5 in 5E spacing
with	110 V AC, 127 V AC, 220 V AC	$\leq 40^\circ\text{C}$	$\leq 50^\circ\text{C}$
with	24 V AC/DC, 24 V DC	$\leq 50^\circ\text{C}$	$\leq 60^\circ\text{C}$
without	110 V AC, 127 V AC, 220 V AC, 230 V AC, 110 V DC, 220 V DC	$\leq 50^\circ\text{C}$	$\leq 60^\circ\text{C}$
without	24 V AC/DC, 24 V DC, 48 V DC, 60 V DC	$\leq 55^\circ\text{C}$	$\leq 65^\circ\text{C}$

With 5E spacing a cover plate 1E wide must be placed between the instruments. See Data Sheet 92-9.35 EN.

5.1.2 19" plug-in card in IP 20 surface-mounting case

The IP 20 surface-mounting case is designed for individual mounting fastened with screws or for snap fastening on rails to EN 50 022 (see dimensional drawing on page 19). For the electrical connections the case has in its connector assembly either blade-type terminals for 6.3 mm tab connectors or screw terminals for wires up to 2.5 mm^2 . To achieve degree of protection IP 20 the ventilation slots in the cover of the 19" plug-in card are covered. If the cases are mounted close-packed in a row the covers must be removed to improve the heat dissipation; the cover must be left on the last instrument in the row to maintain the IP 20 protection. Mounting is only in horizontal rows with the card handle either at the top or bottom. Close-packed mounting in vertical rows is not permitted.

Standard version IP 20 cases always have type D female connectors.

For Ex versions A, B and C only cases with type F female connectors may be used (note coding).

Important! For surface-mounting case with tab connectors the protection before commissioning is to be ensured by integration into a case or any other handling, e.g. blade-type terminals not occupied can be covered with insulated tab connectors.

5.1.3 Explosion-proof 19" plug-in card

Transmitter TEU 315-Ex/325-Ex also has a space requirement of $4E \pm 20$ mm, i.e. up to 21 transmitters can be inserted into a 19" sub-rack. The modules are fastened with 2 screws at the front panel.

To prevent any other 19" plug-in card being inserted into the slot of an explosion-proof module, coding is attached to the transmitters. The slot in the 19" sub-rack must be matched to this coding.

5.1.3.1 Coding of type D connectors to DIN 41 612

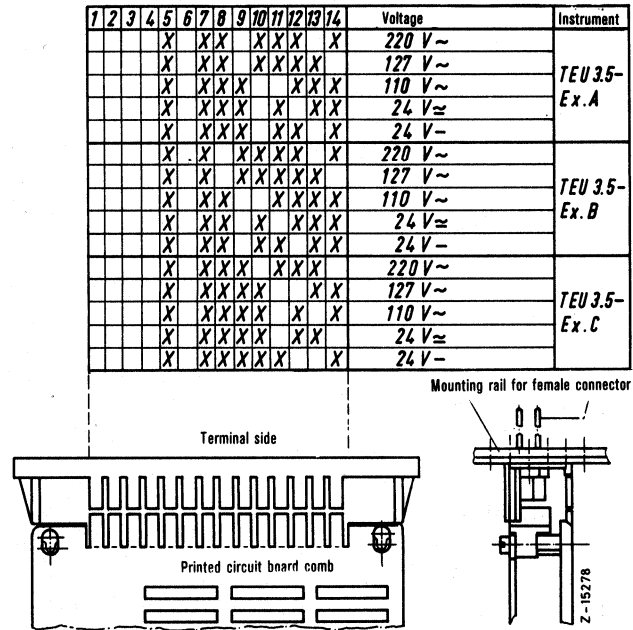

X = Tooth of printed circuit board comb broken off.
 Comb on terminal side broken off to match printed circuit board.
 Printed circuit board cut out at the corners 2.5×6 mm.

5.1.3.2 Coding of type F connector to DIN 41 612

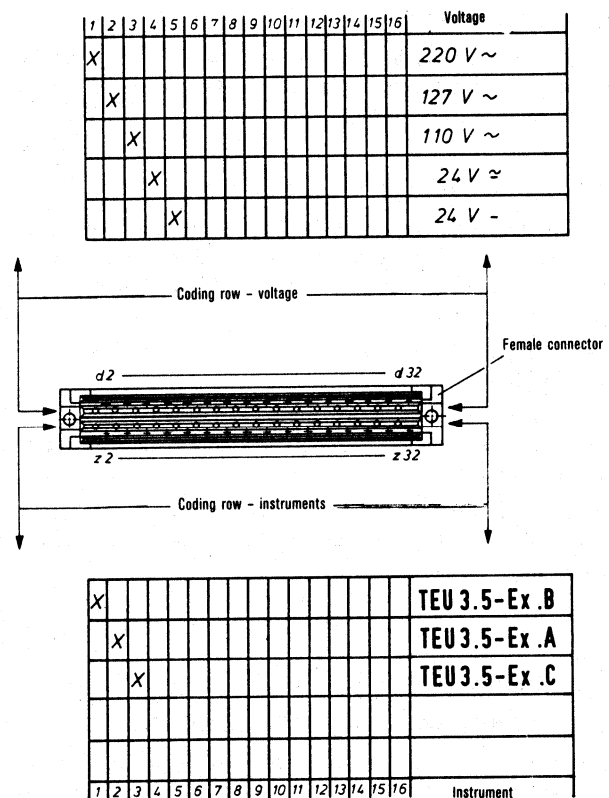

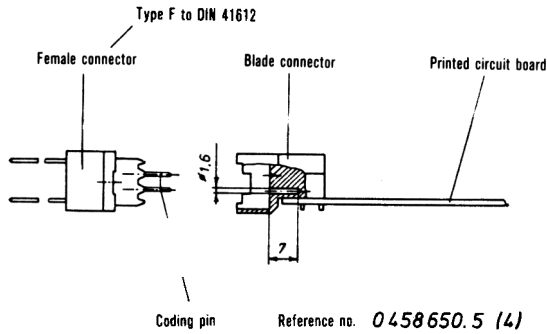

Z-13275

X = Coding pin inserted in female connector
Blade connector drilled to match female connector

5.1.4 IP 54 field enclosure

The case is protected to IP 54 and is suitable for field installation. It must be fastened with the projecting straps (see dimensional drawing page 19 for distance between fastening holes) in such a way that the cable glands are at the bottom. With the case cover removed, the electrical connections can be made at the terminals with wires up to 2.5 mm².

5.2 Installing the measuring signal, output signal and power supply lines

When selecting the line material and installing the measuring signal, output signal and power supply lines, the requirements of DIN VDE 0100 must be met. VDE 0165 must be observed in addition for the explosion-proof version.

With measuring circuit 355 and 365 care must be taken that no current overloading occurs in the input current circuit; therefore an incoming current limitation, e.g. a fuse (< 2 A) is to be provided.

6 Commissioning

If a two-way radio is used for communications during commissioning, this must be used with a transmission power of ≤ 1W at a minimum distance of 1 m from the transmitter.

6.1 Switching on the instrument

The instrument is operational after switching on the mains voltage. In normal operating conditions the input and output are short-circuit proof. The transmitter input and output data are given on the rating plate.

Before a transmitter is switched on the covered range unit must be inserted.

Important!

Removing the range unit with the transmitter switched on is not permitted.

Adjustment work on the potentiometers in the range box and the alarm signalling unit may only be carried out with insulated tools.

7 Alarm signalling unit, sensor break signal contact

The switching currents and switching voltages must not exceed the maximum values specified in the Technical Data even briefly. The built-in contacts are not wired.

If a direct current relay is connected this must be wired with a freewheeling diode for both relay and transistor output.

Wiring with an RC element is recommended if an alternating current relay is connected.

The alternating current relay can be wired in accordance with the following formula:

$$R \approx \frac{U_{NAC}}{0.25 A} \quad (R \triangleq \text{DC resistance of the load})$$

$$C \approx 0.047 \mu\text{F} \text{ where } U_{CN} \geq 2 U_{NAC}$$

Otherwise the general guidelines for the wiring of Reed contacts must be observed!

The relay contacts are not surge voltage proof.

In versions with and without electrical isolation the alarm signalling unit only operates with the output circuit closed.

7.1 Setting the alarm value with relay or transistor output

If the alarm signalling circuit board with relay output or transistor output is built-in, the alarm value is set with potentiometer P1 (see Fig. 8). The procedure for setting the alarm value is as follows:

- Set transmitter input value to correspond to the desired response level of the alarm.
- Slowly turn potentiometer P1 as far as the switching point of the respective output. Reaching the switching point is indicated by the LED.

The set switching hysteresis is 0.5% of the span. NO or NC contact operation can be provided for the switching point as required. The position of the plug-in jumper for relay or transistor output and the LED is shown in Fig. 8.

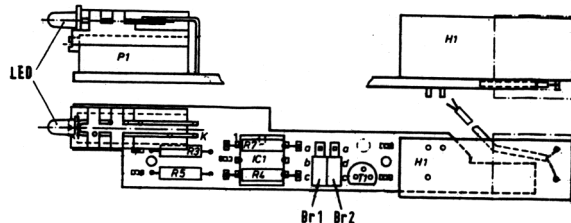

Alarm signalling unit with relay output

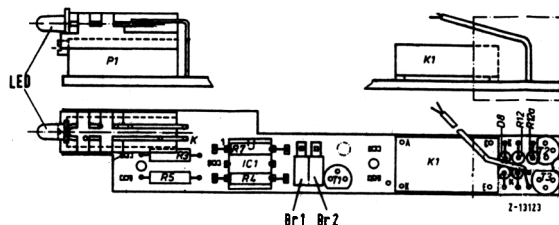

Alarm signalling unit with transistor output

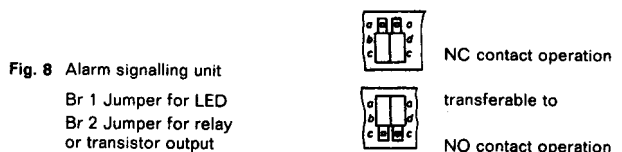

Fig. 8 Alarm signalling unit
Br 1 Jumper for LED
Br 2 Jumper for relay or transistor output

8 Measuring circuit options

The measuring circuit options can be plugged-in and hence can be readily exchanged or retrofitted. This does not necessitate rebalancing of the transmitter.

(Exception: four-wire impedance transformer.)

8.1 Measuring circuit break monitor

In the event of an interruption in the measuring circuit the break monitor is used to drive the transmitter output signal to lower or upper range value and active the break signal contact if built-in.

Versions:

- Thermocouple break monitor
- Two or three-wire thermometer and wire break monitor
- Four-wire impedance converter¹⁾ with or without thermometer and wire break monitor.

In measurement with resistance thermometers in two-wire circuit the break monitor is only required for a reverse action output signal and/or for controlling the built-in break signal contact.

In three or four-wire circuit the resistance thermometer and its leads are monitored.

Driving the amplifier to the lower range value (reverse action) or upper range value (direct action) is determined on the break monitor circuit board with solder links and can be changed there.

8.1.1 Solder links of thermocouple break monitor and of the two or three-wire thermometer and wire break monitor

		Link closed	Link open
Two or three-wire thermometer and wire break monitor	Direct action	C — B G — H	D-F, B-A, B-K D-E, C-J
	Reverse action	A — B G — H	C-B, C-J, D-F B-K, D-E
Thermocouple break monitor	Direct action	D — F C — J B — K	B-A, D-E, C-B G-H
	Reverse action	D — E A — B	C-B, B-K, D-F G-H, C-J

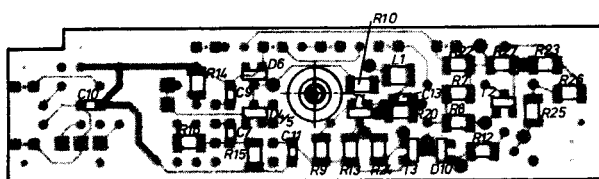
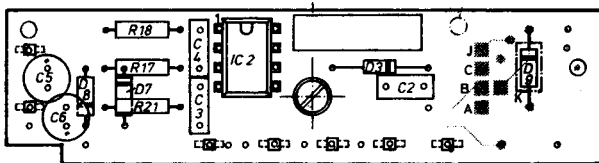

Z-13029/1

8.1.2 Solder links of four-wire impedance converter with thermometer and wire break monitor

Direct action characteristic link C — B
Reverse action characteristic link A — B

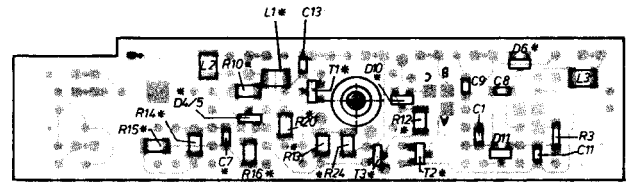
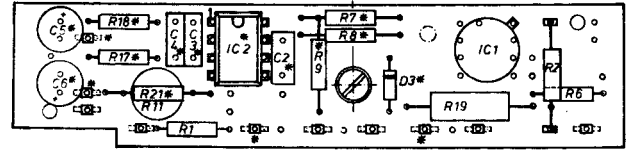

Z-13029/1

8.2 Strain gauge option, measuring circuit 395

Matching the transmitter which is supplied calibrated to the strain gauge primary detector can be accomplished with the range unit potentiometers for start of range and span. If the adjustment range of the potentiometer is not adequate the jumper assignment must be changed. Changes to the calibration cancel the basic adjustment of the range unit.

9 Lead balancing

Lead balancing is not necessary for thermocouples, for sensors in the mV and mA range or for resistance measurements in four-wire circuit. The maximum source resistances specified in the Technical Data must, however, be observed.

In the three-wire circuit with resistance thermometers, where the resistance of the lead wires is equal up to 10 Ω / wire, in principle no lead balancing is necessary. It must be pointed out, however, that, especially with small resistance ranges ($\Delta R < 15 \Omega$), unequal line resistances can lead to considerable zero errors. Small imbalances ($< 0.2 \Omega$) can be compensated with potentiometer P2 in the range unit.

In the two-wire circuit, in temperature difference measurement with resistance thermometers and if teletransmitters are connected, lead balancing is necessary.

Lead balancing can be carried out as follows:

- With one 10 Ω external balancing resistor
- With one 10 Ω internal balancing resistor (only for transmitters in IP 54 construction)
- With the potentiometer for start of range in the range unit.

¹⁾ Replacement of impedance converter necessitates recalibration in instruments with basic adjustment

Regarding a): The external balancing resistor must be connected in the measuring circuit, as shown in the connection diagrams on page 16.

Regarding b): The internal balancing resistor for IP 54 construction transmitters is inserted in the base board. It comprises fixed resistors R1 ... R5 for coarse balancing and potentiometer P1 for fine balancing. For coarse balancing jumpers A-B or C-B must be transferred.

Regarding c): In principle lead resistance balancing is also possible for all transmitters using the potentiometer for start of range in the range unit. It is advisable in this case to use test resistors the value of which coincides with the start of range.

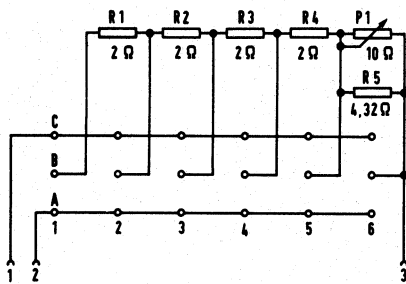

In measuring circuit 371/372 (2-wire) plug-in jumper at C-B
In measuring circuit 391 plug-in jumper at A-B

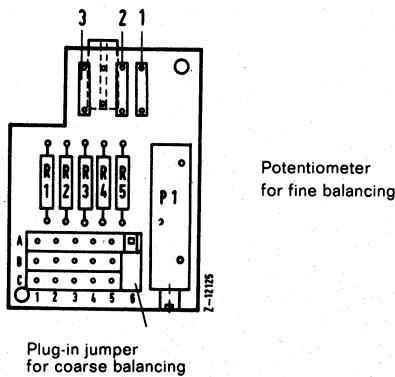

Fig. 9 Internal lead balancing resistor
(Transmitter in IP 54 construction)

9.1 Lead balancing for two-wire circuit

To perform lead balancing the instrument must be switched off and the resistance thermometer short-circuited. The test resistor must be connected in the line. Switch on the instrument and read off the displayed resistance or temperature value. This will normally not coincide with the value given on the test resistor. With the instrument switched on adjust the balancing resistor or potentiometer P2 in the range unit until the nominal readout is obtained. Switch off the instrument; disconnect the test resistor and connect the resistance thermometer.

9.2 Lead balancing for temperature difference measurement (measuring circuit 378)

Lead balancing for temperature difference measurement with resistance thermometers requires 2 test resistors.

Note: With unequal lead resistances lead balancing can be accomplished with potentiometer P2 in the range unit.

9.3 Lead balancing for resistance teletransmitters

For measurement with resistance teletransmitters the tele-transmitter is set to its lower range value. In place of the tele-transmitter a test resistor the size of the lower range value can also be connected between teletransmitter terminals 11 and 13, terminals 12 and 13 being short-circuited (see connection diagrams).

10 Measuring range modification

A full description is given in Service Information 43/11-341-1. The later change of the measuring range is not possible with measuring circuits 371.1, 372.1, 373.1, 374.1.

10.1 General information

The following apparatus is required: H&B transmitter test instrument Kompavi 10 or adjustable precision voltage source, precision current source, resistance decade, class 0.2 ammeter and test reference junction for calibration with internal reference junction compensation, soldering iron.

To change the measuring range solder links only are changed; resistors are not replaced.

The procedure always includes two basic steps:

1. Determine the jumper assignment for the span.
2. Determine the jumper assignment for the lower range value (0 or 4 mA).

Fine adjustment is carried out with potentiometers P1 and P2. P1 is used to set the span and P2 to set the lower range value. If the range of P2 is not adequate resistor R11 and/or R12 must be connected or disconnected.

Check the lower and upper range value of the output signal several times.

The position of the solder points and of potentiometers P1 and P2 is shown inside the cover of each range unit. A resistance value must be calculated for the start of range and reproduced as precisely as possible with resistors R11 ... R19.

IP 54 enclosure

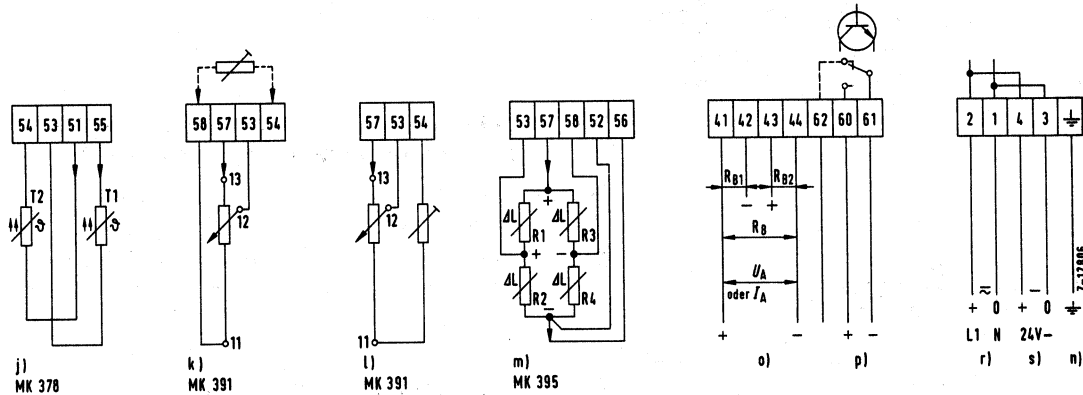
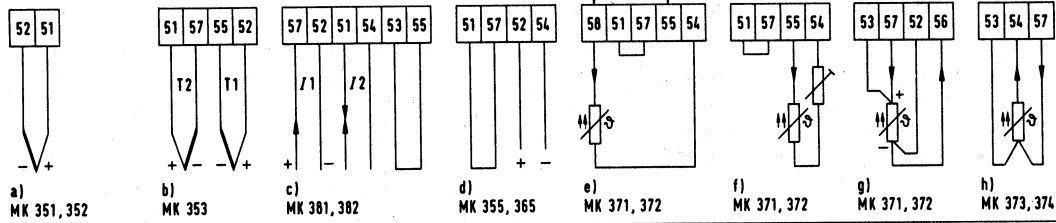

19" plug-in card and IP 20 surface-mounting case

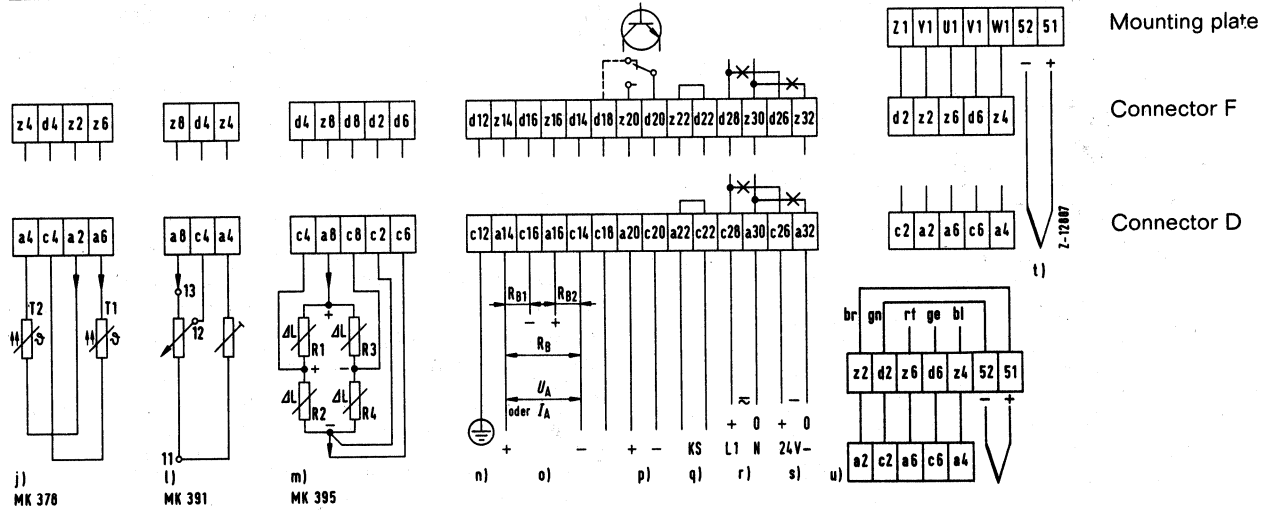
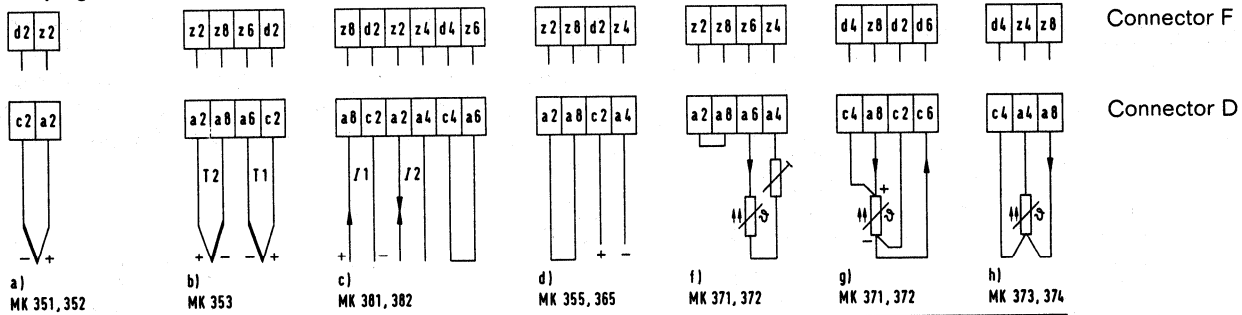

MK = Measuring circuit

Fig. 10 Connection diagrams

- a) Thermoelectric voltage measurement and mV measurement with and without reference junction compensation
- b) Temperature difference measurement with 2 thermocouples
- c) μA , mA measurement with I_1 , current sum or difference measurement with $I_1 \pm I_2$
- d) Voltage measurement with built-in voltage divider ($U \geq 150$ mV), rotational speed or alternating measurement
- e) Temperature measurement with Pt 100 resistance thermometer in two-wire circuit, internal line resistance balancing
- f) Temperature measurement with Pt 100 resistance thermometer in two-wire circuit, external line resistance balancing or with zero potentiometer
- g) Temperature measurement with Pt 100 resistance thermometer in four-wire circuit
- h) Temperature measurement with Pt 100 resistance thermometer in three-wire circuit
- j) Resistance difference measurement, line resistance balancing with zero potentiometer T 2 - T 1

- k) Resistance teletransmitter measurement, internal line resistance balancing (11 = low end of teletransmitter, 12 = pick-up, 13 = high end of teletransmitter)
- l) Resistance teletransmitter measurement, external line resistance balancing or zero point potentiometer (11 = low end of teletransmitter, 12 = pick-up, 13 = high end of teletransmitter)
- m) Strain gauge measurement
- n) PE-connection required for Ex-version. For the non Ex-version a measuring earth terminal is required for radio interference suppression.
- o) Output signal current or voltage, $R_{B1} > R_{B2}$ (R_{B2} = output at the interlock diode), change polarity for reverse action characteristic
- p) Measuring circuit break signal contact or alarm signalling unit
- q) Monitoring loop
- r) AC/DC power supply for all voltages except 24 V DC (\times = interruption) for power supply > 24 V
- s) 24 V DC power supply
- t) Connection of internal reference junction compensation with 19" plug-in card (see Fig. 3)
- u) Connection for the internal reference junction compensation with 19" plug-in cards (see Fig. 2).

11 Test jacks

Boundary conditions

The H & B test instrument Kompavi 10 can be used for test purposes on non explosion-proof transmitters.

For EEx ib explosion-proof transmitters the test instrument must keep within the alarm values specified in certificate of conformity PTB No. Ex-84/2123X.

We recommend the Portavo 630, PTB No. Ex 81/2145 made by Knick as test instrument.

- Sensor and wire break monitor respond briefly during test/measure switchover (irrespective of whether a test sensor is connected).
- Testing and calibration via test jacks to standard error limits for spans $\geq 25 \Omega$, $\geq 1 \text{ mV}$, $\geq 100 \mu\text{A}$ (at $< 25 \Omega$ the contact resistance causes an incremental error of approx. 0.1Ω).

- In resistance measurements the voltage drop at the sensor can only be imprecisely determined (effect of line resistances!).
- When checking the thermoelectric voltage with attached or internal reference junction compensation the reference junction compensation voltage is not detected. Calibration check only with substitute reference junction or by taking into account the ambient temperature at the reference junction.

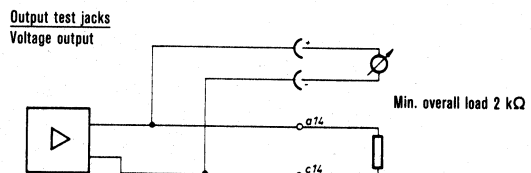
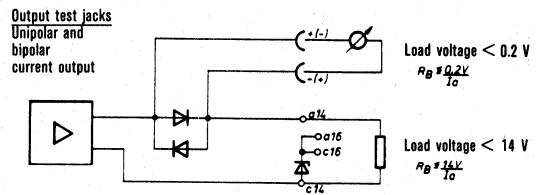
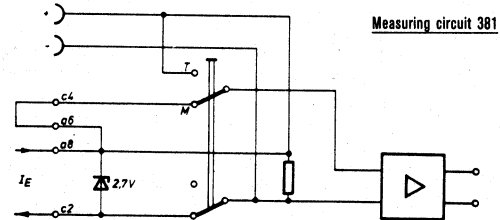
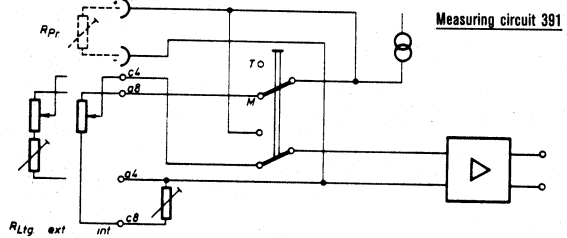
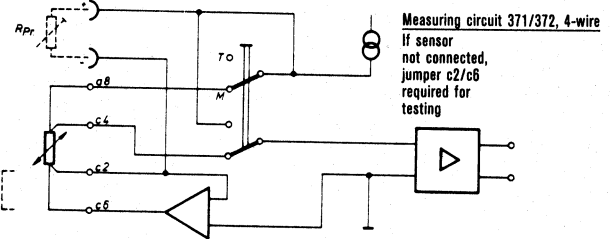
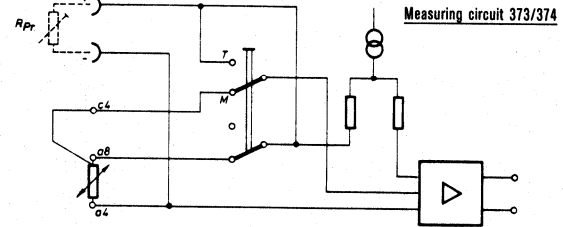
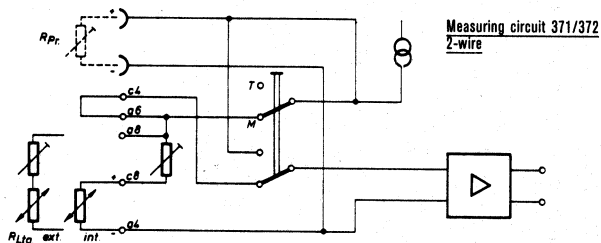
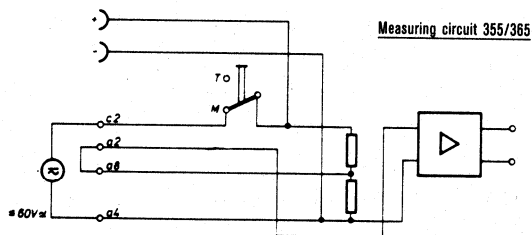
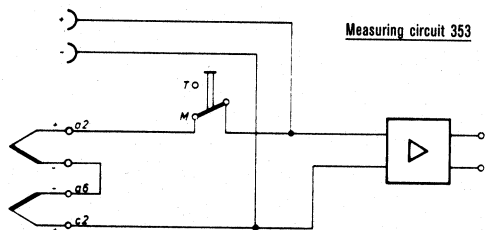
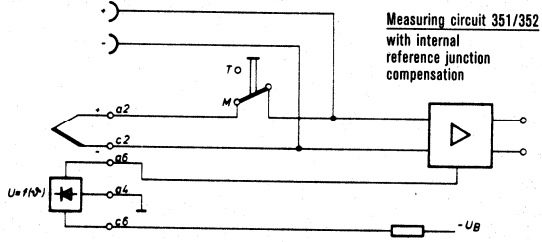
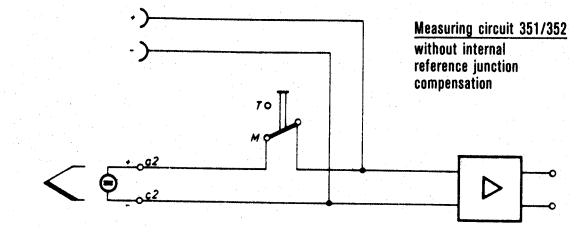

Z-13243

Bild 11 Test jack circuits

- With input circuit IEx ib) IIC note certificate of conformity!

Assignment of test jack modules and measuring circuits:

Measuring circuit 351	}	Test jack module (soldered in) 11335.132
Measuring circuit 352		
Measuring circuit 353		
Measuring circuit 355	}	11335.133
Measuring circuit 365		
Measuring circuit 371 2-wire		11335.134
Measuring circuit 372 2-wire		
Measuring circuit 373		
Measuring circuit 374		
Measuring circuit 391		
Measuring circuit 371 4-wire	}	11335.135
Measuring circuit 372 4-wire		
Measuring circuit 381		11335.136

With a test jack module soldered in, range units can only be interchanged for the measuring circuits assigned in the table.

12 Explosion-proof version

The input circuit of transmitter TEU 315-Ex and TEU 325-Ex is approved for type of protection intrinsic safety EEx ib IIC or EEx ia IIC. The input circuit may be installed in hazardous areas, taking into account the certificate of conformity (see Section 2). As only the input circuit is intrinsically safe, the transmitter must be installed outside the hazardous area.

When installing the transmitter, the regulations on electrical apparatus in hazardous areas (ElexV), the regulations on the installation of electrical systems in hazardous operating sites (DIN VDE 0165) and the certificate of conformity (49/11-38 Ex) must be observed.

If an instrument with a certified intrinsically safe output circuit is connected to the intrinsically safe input circuit of the transmitter, the intrinsic safety of the connection must be demonstrated in accordance with DIN VDE 0165.

If the intrinsically safe circuit has to be grounded for functional reasons by connecting it to the bonding conductor, grounding may be effected at one point only.

For transmitters TEU 315/325-Ex.C the intrinsically safe input circuit and the intrinsically safe output circuit must be ungrounded and electrically isolated from each other over their complete course outside the instrument.

Work on an explosion-proof instrument may be carried out by any person and in any workshop. The apparatus must, however, be tested and certified by an expert prior to recommissioning. This is not necessary if the work has been carried out by the manufacturer's authorized personnel.

In this case the repairer must show the appropriate identification. After the repair work has been completed, the data and repairer's mark (e.g. H & B certificate number) must be affixed to the instrument.

An exception to these conditions is work to change the measuring range, which may be carried out by the operator's trained personnel. Note that damage to or short circuiting of resistors or other components that determine the intrinsic safety must be avoided without fail. Covering sheets must therefore be used during soldering work.

13 Trouble shooting

Faults and unusual stress

If it is likely that the protection has been impaired the apparatus shall be made inoperative and be secured against any unintended operation.

The protection is likely to be impaired

- if the instrument shows visible damages
- if the instrument does not work
- after long storage time under unfavorable conditions
- after heavy transportation stress.

If faults occur the cause must be sought in the sensor and its lead wires. In the case of voltage measurement this is effected by testing for continuity and then testing the measured voltage with a suitable test instrument (e.g. portable compensator). Then test the output signal circuit by connecting an ammeter. In the case of resistance measurement the resistance to be measured must be simulated and the current checked at the transmitter output.

If the transmitter input and output circuits are functioning correctly, the fault must be sought in the transmitter electronics. Such an error can be eliminated with the aid of the circuit diagram or by replacing electronic units.

14 Maintenance

Transmitter TEU 315/325 requires no regular maintenance.

15 Packing instructions

If the original packing is no longer available, the transmitter must be packed in a sufficiently large box lined with shock-absorbing material (excelsior, spun rubber or similar). If excelsior is used, the packed layer should be at least 10 cm on all sides. Before packing the instrument has to be wrapped in paper.

For overseas shipment the transmitter must additionally be sealed airtight in polyethylene at least 0.2 mm thick together with a dessicant (e.g. silica gel). Furthermore, for this type of shipment the crate should be lined with a layer of kraft paper.

These packing instructions also apply when returning the instrument to the manufacturer (e.g. for recalibration, repair).

16 Dimensional drawings (dimensions in mm)

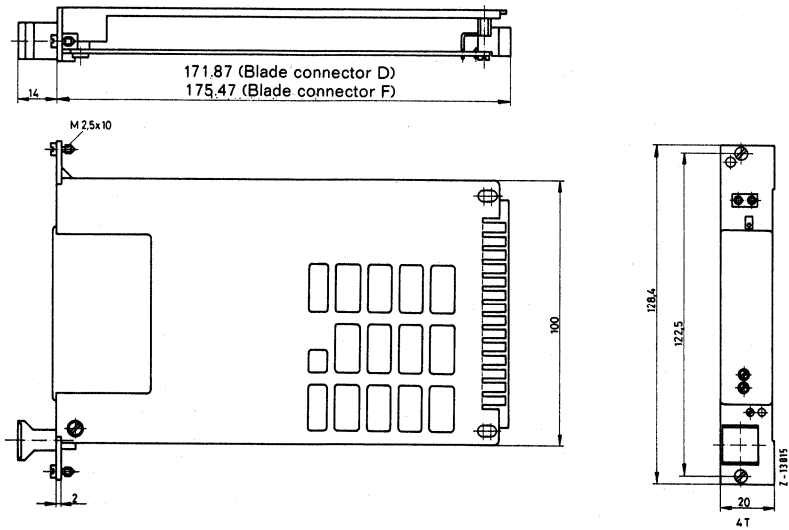

19" plug-in card

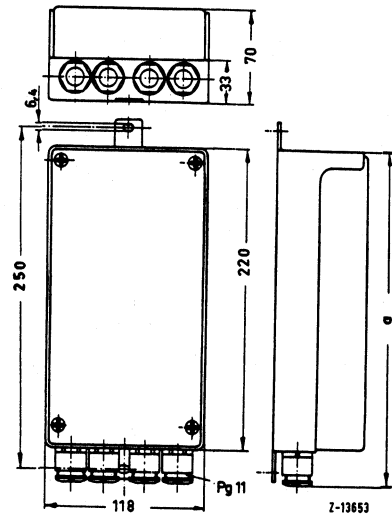

IP 54 field enclosure

Dimension a ≈ 245 mm with Pg 11 cable glands

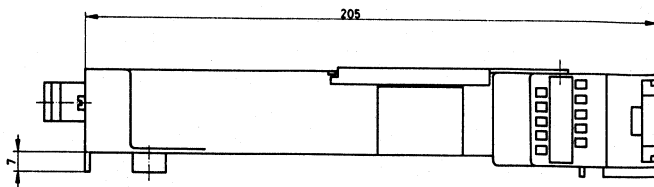

Top hat rail acc. to DIN EN 50 022
Height 15 mm or 7.5 mm

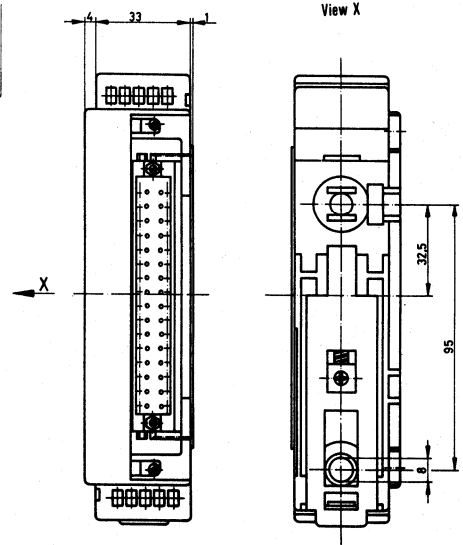
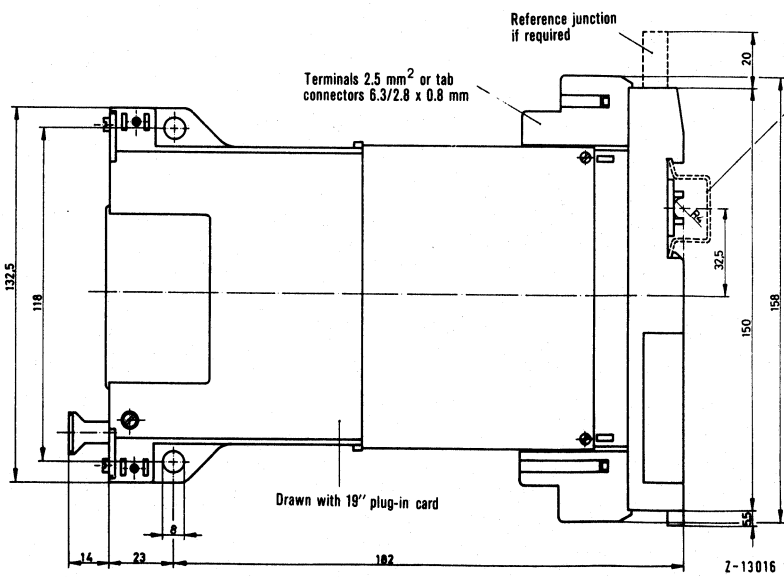

IP 20 surface-mounting case



ABB Automation Products GmbH

Borsigstrasse 2

D-63755 Alzenau

Phone +49(0)60 23 92 - 0

Fax +49(0)60 23 92 - 33 00

<http://www.abb.com>

Subject to technical changes.
Printed in the Fed. Rep. of Germany
42/11-34 EN Rev. 05
Edition 07.01

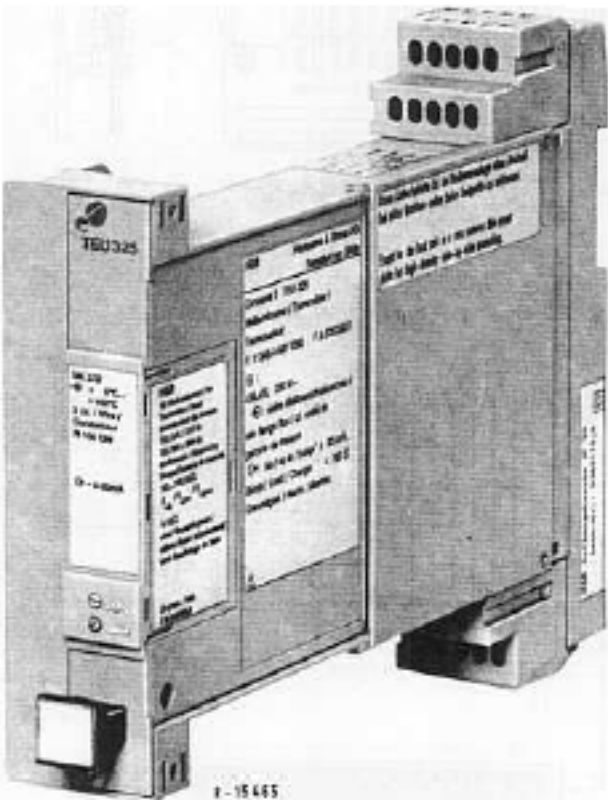



5A7325

5A7325
 100 V AC
 100 VA
 100 W
 100 A
 100 V AC

5A7325
 Schmelzsicherungsautomat
 für Schaltkreise
 mit Nennstrom
 100 A
 Nennleistung
 100 VA
 Nennleistung
 100 W
 Nennstrom
 100 A
 Nennspannung
 100 V AC
 Nennleistung
 100 VA
 Nennleistung
 100 W
 Nennstrom
 100 A
 Nennspannung
 100 V AC

5A7325
 100
 100 V
 100 VA
 100 W
 100 A
 100 V AC
 100 VA
 100 W
 100 A
 100 V AC

Dieser Schmelzsicherungsautomat ist ein Schutzorgan des Schaltkreises und ist nicht für den Schutz von Personen oder Sachen geeignet.