



- High dynamics
- Final control element for closed control loops
- 5/3 –way function

Proportional directional control valves MPYE

Key features

FESTO



General information

- The directly actuated proportional directional control valve has a position-controlled spool. This transforms an analogue input signal into a corresponding opening cross-section at the valve outputs.
- In combination with an external position controller and displacement encoder, a precise pneumatic positioning system can be created.
- Flow control function for varying cylinder speed
- 5/3-way function for varying the direction of movement

Wide choice of variants

- Setpoint value input
 - Analogue voltage signal
 - Analogue current signal
- Flow rates from 100 ... 2000 l/min

Proportional directional control valves MPYE

Key features and type codes

Short machine cycle times – fast switching of programmed flow rates

- Reduce machine cycle times by optimising cylinder speeds
 - Assembly technology
 - Handling technology
 - Furniture industry
- A: Proportional valves allow different speed levels and speed ramps to be set.
- B: Speed regulation with directional control valves is more difficult and is performed by means of exhaust air flow control.

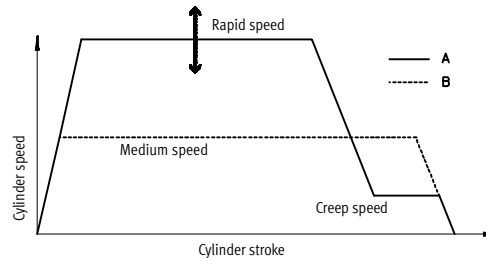

Flexible cylinder speeds – Achieving variable flow rates

- Flexibly adapting cylinder speeds to the process. Traversing individual acceleration ramps (gentle approach with delicate goods)
 - Automobile suppliers
 - Production technology
 - Conveyor technology
 - Test engineering

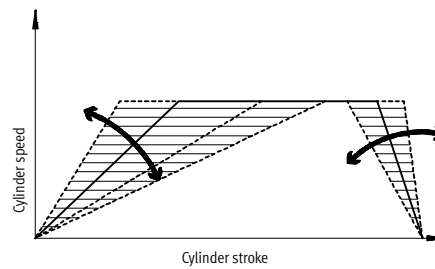

Proportional directional control valve as final control element – Dynamic and fast changing of flow rates

- Fatigue tests
- SoftStop with end-position controller SPC11

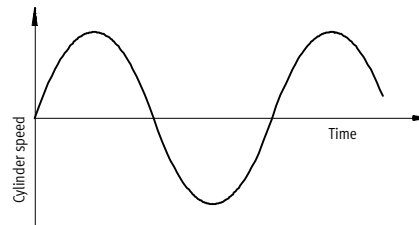

Type codes

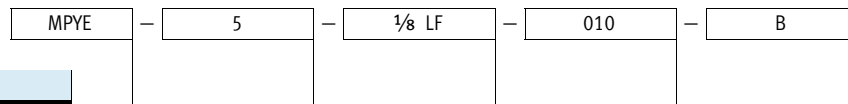

Type	
MPYE	Proportional directional control valve
Valve function	
5	5/3-way valve
Pneumatic connection	
M5	M5
1/8 LF	G1/8 Low Flow
1/8 HF	G1/8 High Flow
1/4	G1/4
3/8	G3/8
Setpoint value input	
010	Analogue voltage signal
420	Analogue current signal
Generation	
B	B series

Proportional directional control valves MPYE

Peripherals overview

FESTO

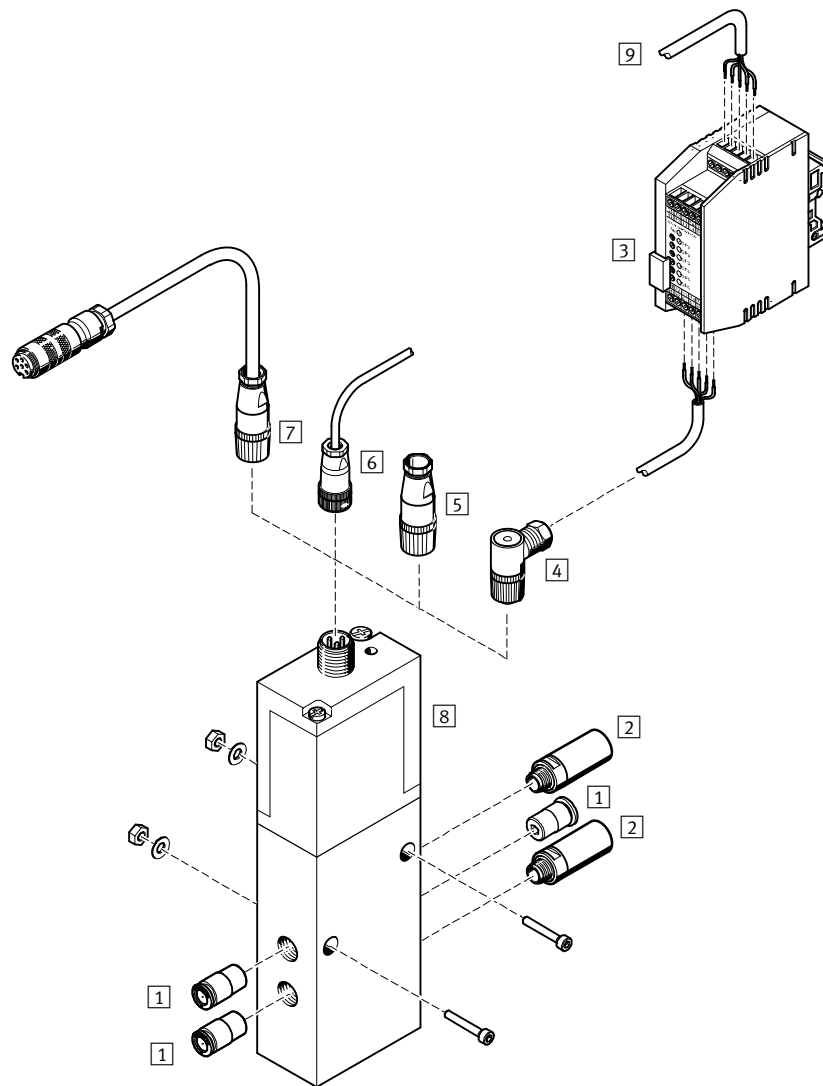

Accessories		
	Description	→ Page/Internet
1	Push-in fitting QS	quick star
2	Silencer	u
3	Setpoint module MPZ	–
4	Sensor socket SIE-WD-TR	8
5	Sensor socket SIE-GD	8
6	Connecting cable KMPYE	8
7	Connecting cable KVIA-MPYE	8
8	Proportional directional control valve MPYE	5
9	Digital input/output	–

Proportional directional control valves MPYE

Technical data

Function

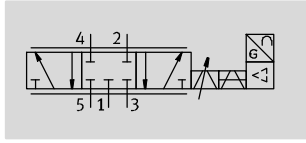

Variants

- Setpoint value input as analogue voltage signal 0 ... 10 V
- Setpoint value input as analogue current signal 4 ... 20 mA



- - Voltage
17 ... 30 V DC
- - Flow rate
100 ... 2000 l/min
- - Pressure
0 ... 10 bar

General technical data						
Pneumatic connection	M5	G1/8		G1/4	G3/8	
		Low flow	High flow			
Valve function	5/3-way, normally closed					
Constructional design	Piston spool, directly actuated, controlled piston spool position					
Sealing principle	Hard					
Actuation type	Electrical					
Type of reset	Mechanical spring					
Type of pilot control	Direct					
Direction of flow	Non-reversible					
Type of mounting	Via through-holes					
Mounting position ¹⁾	Any					
Nominal size	[mm]	2	4	6	8	10
Standard nominal flow rate	[l/min]	100	350	700	1400	2000
Product weight	[g]	290	330	330	530	740

1) If the proportional directional control valve is in motion during operation, it must be mounted at right angles to the direction of movement.

Flow rate q at 6 → 5 bar as a function of the setpoint voltage U
Voltage type MPYE-5...-010-B

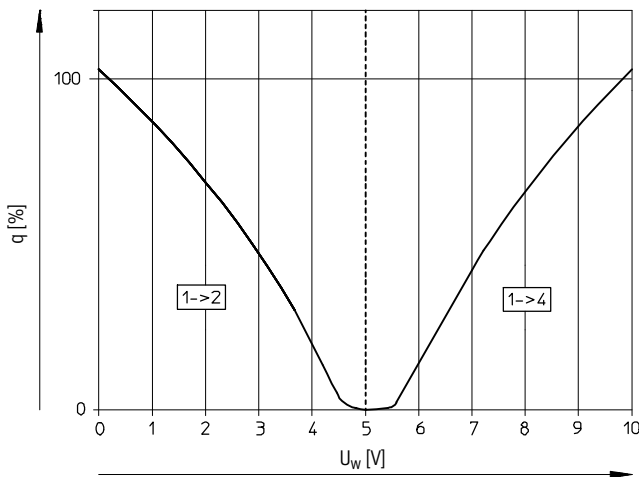

Current type MPYE-5...-420-B

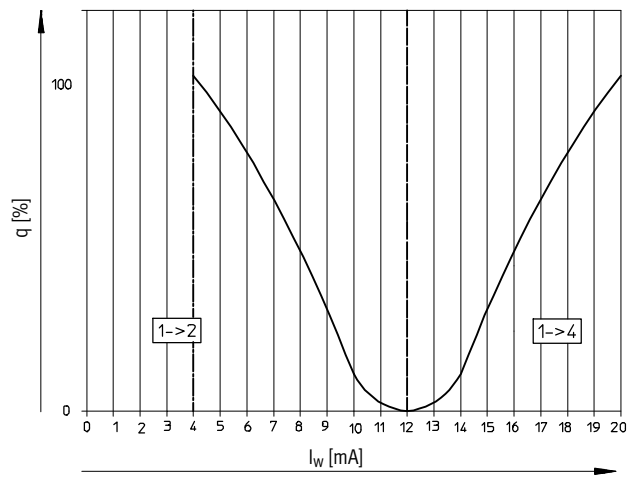

Proportional directional control valves MPYE

Technical data

Electrical data			M5	G1/8 Low flow	High flow	G1/4	G3/8
Pneumatic connection							
Power supply	[V DC]	17 ... 30					
Max. current consumption	in mid-position	[mA]	100				
	at full stroke	[mA]	1 100				
Setpoint value	Voltage type	[V DC]	0 ... 10				
	Current type	[mA]	4 ... 20				
Max. hysteresis ¹⁾		[%]	0.4				
Valve mid-position	Voltage type	[V DC]	5 (±0.1)				
	Current type	[mA]	12 (±0.16)				
Duty cycle ²⁾		[%]	100				
Critical frequency ³⁾		[Hz]	125	100	100	90	65
Safety setting	Active mid-position in the event of setpoint value cable break						
Protection against polarity reversal	Voltage type	For all electrical connections					
	Current type	For setpoint value					
Protection class	IP65						
Electrical connection	4-pin plug socket, round design, M12x1						

- 1) Referred to the maximum stroke of the piston spool.
- 2) The proportional direction control valve automatically switches off if it overheats (goes to mid-position) and switches back on once it cools down.
- 3) Corresponds to the 3dB frequency at the maximum movement stroke of the piston spool.

Operating and environmental conditions	
Operating pressure	[bar] 0 ... 10
Operating medium	Compressed air in accordance with ISO 8573-1:2010 [6:4:4]
Note on operating/pilot medium	Operation with lubricated medium not possible
Ambient temperature	[°C] 0 ... 50
Vibration resistance ¹⁾	To DIN/IEC 68 Parts 2 - 6, severity level 2
Continuous shock resistance ¹⁾	To DIN/IEC 68 Parts 2 - 27, severity level 2
CE symbol	To 89/336/EEC (EMC regulation)
Temperature of medium	[°C] 5 ... 40, condensation not permitted

- 1) If the proportional directional control valve is in motion during operation, it must be mounted at right angles to the direction of movement.

Materials

Sectional view

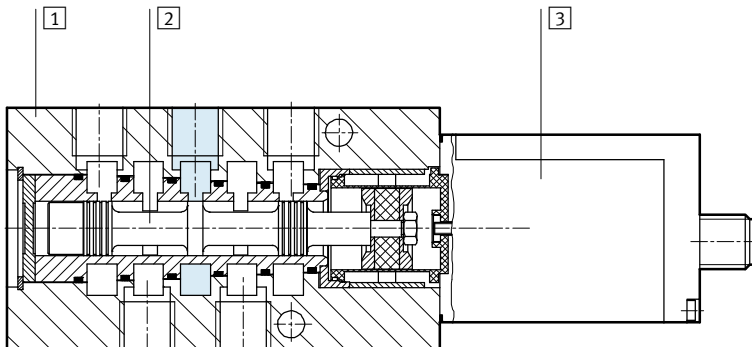

1	Housing	Anodised aluminium
2	Valve spool	Tempered aluminium
3	Housing for electronics	Galvanised acrylic butadiene styrene
-	Seals	Nitrile rubber

Proportional directional control valves MPYE

Technical data

FESTO

Dimensions

Download CAD data → www.festo.com

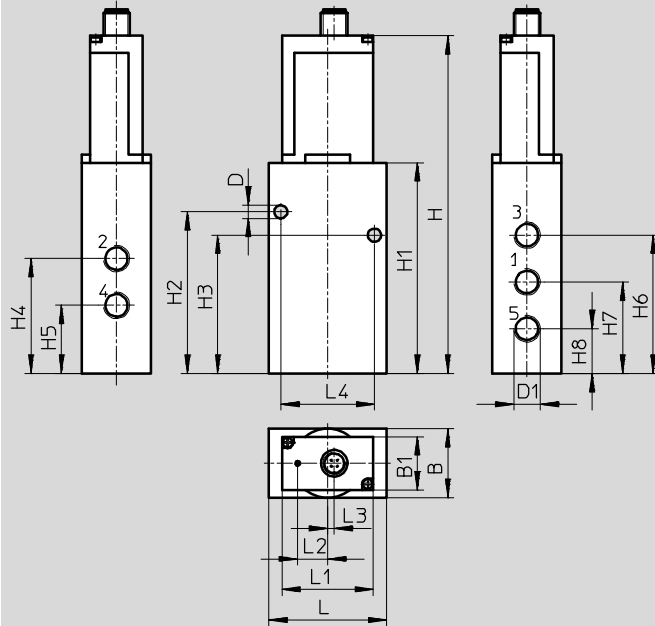

Pneumatic connection D1	B	B1	D ∅	H	H1	H2	H3	H4
M5	26	–	5.5	129.9	69	56.1	38.1	32.1
G $\frac{1}{8}$	26	–	5.5	149.3	88.4	71.3	55.1	45.8
G $\frac{1}{4}$	35	26	6.5	164.6	103.7	79.6	68.1	56.6
G $\frac{3}{8}$	40	26	6.5	176.6	115.7	98.4	79.4	65.4

Pneumatic connection D1	H5	H6	H7	H8	L	L1	L2	L3	L4
M5	20.1	38.1	26.1	14.1	45	–	14.8	3.2	32
G $\frac{1}{8}$	26.8	55.3	36.3	17.3	45	–	14.8	3.2	35
G $\frac{1}{4}$	33.6	68.1	45.1	22.1	58	45	14.8	3.2	46
G $\frac{3}{8}$	37.4	82.4	51.4	20.4	67	45	14.8	3.2	54

Terminal allocation

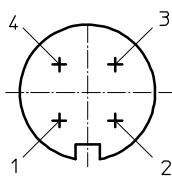

- 1 24 V DC, supply voltage
- 2 GND
- 3 U_w/I_w setpoint input
- 4 GND





Ordering data

Pneumatic connection	Voltage type 0 ... 10 mV		Current type 4 ... 20 mA	
	Part No.	Type	Part No.	Type
M5	154200	MPYE-5-M5-010-B	162959	MPYE-5-M5-420-B
G $\frac{1}{8}$	151692	MPYE-5- $\frac{1}{8}$ LF-010-B	161978	MPYE-5- $\frac{1}{8}$ LF-420-B
	151693	MPYE-5- $\frac{1}{8}$ HF-010-B	161979	MPYE-5- $\frac{1}{8}$ HF-420-B
G $\frac{1}{4}$	151694	MPYE-5- $\frac{1}{4}$ -010-B	161980	MPYE-5- $\frac{1}{4}$ -420-B
G $\frac{3}{8}$	151695	MPYE-5- $\frac{3}{8}$ -010-B	161981	MPYE-5- $\frac{3}{8}$ -420-B

Proportional directional control valves MPYE

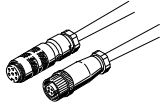
Accessories



Ordering data			
	Description	Cable length [m]	Part No. Type
Connecting cable		Technical data → Internet: kmpye, kvia	
	Screened	5	151909 KMPYE-5
	Connecting cable to the analogue module of valve terminal type 03	5	161984 KVIA-MPYE-5
		10	161985 KVIA-MPYE-10
Sensor socket		Technical data → Internet: sie-gd	
	Straight, 4-pin, M12x1	–	18494 SIE-GD
Sensor socket		Technical data → Internet: sie-wd	
	Angled, 4-pin, M12x1	–	12956 SIE-WD-TR
Setpoint module		Technical data → Internet: mpz	
	Generation of 6+1 analogue setpoint values	–	546224 MPZ-1-24DC-SGH-6-SW5

1) Max. 10 m