

Ex d

NEW

TECHNICAL FEATURES

New explosion proof limit switches YFC are conceived to satisfy the most common installation requirements. Easy wiring and quick installation, solidity, reliability in the course of time are the main advantages of new limit switches in aluminium alloy, provided with a wide range of actuators and contacts combinations, which allow to afford the best solution for proper functioning of a system in dangerous zone.

ACCESSORIES

Cable gland type FL1IBK.
 (*) To be ordered specifying the item code



CARATTERISTICHE TECNICHE

I nuovi finecorsa antideflagranti tipo YFC sono stati realizzati per soddisfare le più comuni esigenze di installazione. Comodità di cablaggio, robustezza, affidabilità nel tempo, rapida installazione, i nuovi finecorsa costruiti in lega di alluminio sono dotati di una vasta gamma di azionatori e molteplici combinazioni di contatti consentendo di realizzare la soluzione ottimale per un perfetto funzionamento del sistema situato in area pericolosa.

ACCESSORI

Pressacavo tipo FL1IBK.
 (*) Ordinare separatamente specificando il cod. articolo

CONFORMITY TO STANDARDS

Explosion proof enclosures manufactured in compliance with Standards IEC 60079-0: 2004, IEC 60079-1: 2003, IEC 61241-0: 2004, IEC 61241-1: 2004, EN 60079-0: 2006, EN 60079-1: 2004, EN 61241-0: 2006, EN 61241-1: 2004 and with EUROPEAN DIRECTIVE 94/9/EC: 1994.

INSTALLATION AREAS

Limit switches are used in dangerous areas, both indoor and outdoor, wherever the risk of explosion or ignition of combustible gas and dusts is present. They are installed in: **zone 1, zone 2, zone 21, zone 22.**

APPLICATIONS

Explosive atmospheres

- Chemical, petrochemical, pharmaceutical industries;
- onshore and offshore, ship industries;
- areas at risk of explosion and fire;
- OIL and GAS industries.

CERTIFICATION AND USE

Execution **CE 0722: Ex II 2(1) GD Ex d IIC T6 Ex tD A21 IP66/67 T85°C**
 Ambient temperature: **-20°C +55°C**
 ATEX CE test certificate: **SIRA 07 ATEX 1316**
 IECEx Certificate: **AVAILABLE**

HEALTH AND SAFETY

All electrical equipment must always be installed and maintained in accordance with your country's legislative regulations concerning health and safety at work, and always in compliance with Cortem standards. The user is responsible for choosing, installing, operating and maintaining electrical equipment in compliance with the relative laws and regulations in force. Each fixture is supplied with a manual with instructions for use, safety and maintenance..

CONFORMITA' ALLE NORMATIVE STANDARD

Custodie a prova di esplosione costruite in accordo alle normative IEC 60079-0: 2004, IEC 60079-1: 2003, IEC 61241-0: 2004, IEC 61241-1: 2004, EN 60079-0: 2006, EN 60079-1: 2004, EN 61241-0: 2006, EN 61241-1: 2004 ed alla DIRETTIVA EUROPEA 94/9/EC: 1994.

LUOGHI DI INSTALLAZIONE

I finecorsa vengono usati in luoghi pericolosi all'interno o all'esterno dove esiste pericolo di esplosioni o combustioni di gas e di polveri combustibili, vengono installati nelle seguenti zone: **zona 1, zona 2, zona 21, zona 22.**

APPLICAZIONI

Atmosfera esplosiva

- industrie chimiche, petrolchimiche e farmaceutiche;
- onshore ed offshore, navale;
- luoghi con pericolo di esplosione ed incendio;
- industrie OIL and GAS.

CERTIFICAZIONI ED ESECUZIONE

Esecuzione **CE 0722: Ex II 2(1) GD Ex d IIC T6 Ex tD A21 IP66/67 T85°C**
 Temperatura ambiente: **-20°C +55°C**
 Certificato Atex di esame CE: **SIRA 07 ATEX 1316**
 Certificato IECEx: **DISPONIBILE**

SALUTE E SICUREZZA

Nel mondo tutti gli equipaggiamenti elettrici devono essere installati e mantenuti secondo le disposizioni legislative in materia di sicurezza e salute sul lavoro in vigore nello Stato, sempre e comunque in accordo agli standard CortemGroup. E' responsabilità dell'utilizzatore scegliere, installare, operare e mantenere gli equipaggiamenti elettrici in conformità alla relativa legislazione e alle norme in uso, inoltre un libretto per le istruzioni di sicurezza, uso e manutenzione è posto assieme ad ogni finecorsa.



TECHNICAL FEATURES

Rated voltage:	max. 500Vac, 250Vdc
Rated frequency:	max. 50/60 Hz
Rated current:	24Vac – 50/60Hz 10A
	120Vac – 50/60Hz 6A
	230Vac – 50/60Hz 3.1A
	240Vac – 50/60Hz 3A
	400Vac – 60/50Hz 1.8A
	24Vdc 2.8A
	125Vdc 0.55A
	250Vdc 0.27A
Connecting cable size:	0.75 ... 2.5
Cable entry:	1 hub ISO20x1,5
Mounting:	Allowed in any position
Precision (measured after 1 million operations):	0.05 mm (upon closing point)
Minimum control speed:	Slow action 0.06m/s
	snap action 0.001m/s



DATI TECNICI

Tensione nominale::	max. 500Vac, 250Vdc
Frequenza nominale:	max. 50/60 Hz
Corrente nominale::	24Vac – 50/60Hz 10A
	120Vac – 50/60Hz 6A
	230Vac – 50/60Hz 3.1A
	240Vac – 50/60Hz 3A
	400Vac – 60/50Hz 1.8A
	24Vdc 2.8A
	125Vdc 0.55A
	250Vdc 0.27A
Dimensione cavi di collegamento:	0.75 ... 2.5
Entrata dei cavi:	n°1 imbocco ISO20x1,5
Posizioni di montaggio:	Consentito in tutte le posizioni
Precisione (misurata dopo 1 milione di operazioni):	0.05 mm (sul punto di chiusura)
Velocità minima di azionamento:	ad azione lenta 0.06m/s
	ad azione rapida 0.001m/s

Ex d



CONSTRUCTION FEATURES - CARATTERISTICHE COSTRUTTIVE

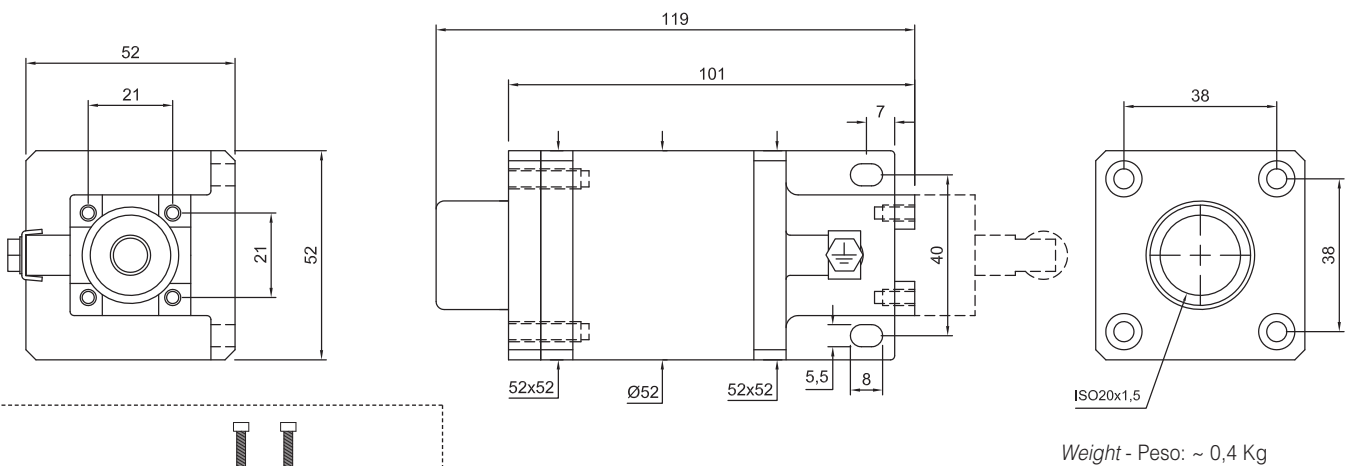

Weight - Peso: ~ 0,4 Kg

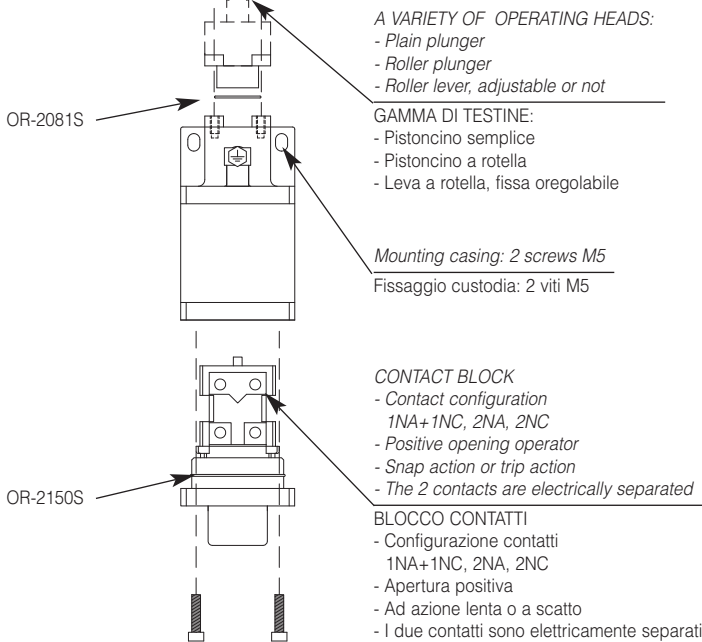

INTERNAL ASSEMBLY SCHEME - SCHEMA D'ASSEMBLAGGIO

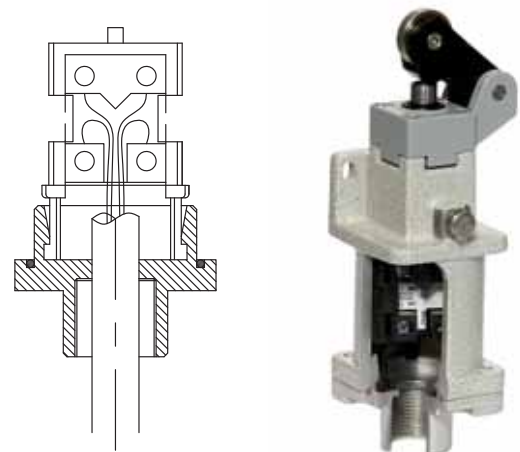

ORDER CODE - CODICE D'ORDINE

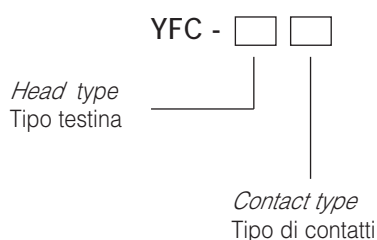

EXAMPLE - ESEMPIO

YFC - [E11] [Z11]

Limit switches with stainless steel plain plunger and snap action contacts (1NO+1NC)

Finecorsa con pistoncino semplice inox e contatto a scatto (1NO+1NC)

Ex d



STRUCTURE

YFC limit switch is made by an aluminium alloy body UNI-4514 o UNI-3049, UNI-3051, UNI-3599. Inside is a nylon supporting device, where the block of contacts is mounted. NBR sealing rings are resistant to temperatures from -30°C to +100°C. All screws are stainless steel and minimum quality 8.8. Epoxy powder painting grey RAL7035.

LEXICON

POSITIVE OPENING OPERATION



A control switch, with one or more break-contact elements, has a positive opening operation when the switch actuator (C) ensures full contact opening of the break contact. For the part of travel that separates the contact, there must be a positive drive, with no resilient member (e.g. springs), between the moving contacts and the point of the actuator to which the actuating force is applied. The positive opening operation is not applicable to N.O. contacts.

Control switches with positive opening operation may be provided with either snap action or slow action contacts elements. To use several contacts on the same control switch with positive opening operation, they must be electrically separated from each other, if not, only one may be used.

SNAP ACTION

Snap action contacts are characterised by a release position. Snap breaking of moving contacts is independent of the switch actuator's speed and contributes to regular electric performance even for slow switch actuator speeds.

SLOW ACTION

Slow action contacts are characterised by a release position that is the same as the operating position. The switch actuator's speed directly conditions the travel speed of contacts.

MINIMUM ACTUATION FORCE / TORQUE

The minimum amount of force / torque that is to be applied to the switch actuator to produce a change in contact position.

MINIMUM FORCE / TORQUE TO ACHIEVE POSITIVE OPENING OPERATION

The minimum amount of force / torque that is to be applied to the switch actuator to ensure positive opening operation of the N.C. contact.

CoSTRUZIONE



Il finecorsa tipo YFC è costituito da un corpo in lega di alluminio UNI-4514 o UNI-3049, UNI-3051, UNI-3599, all'interno è installato un supporto in nylon nel quale viene montato il blocco contatti. Le guarnizioni sono in NBR resistenti a temperature da -30°C a +100°C. Tutta la viteria è in inox qualità min 8.8. La verniciatura viene eseguita con polvere epossidica di colore grigio RAL7035.

TERMINOLOGIA

APERTURA POSITIVA



Un interruttore di controllo, avente uno o più contatti di apertura, possiede le caratteristiche di apertura positiva quando l'attuatore (C) di commutazione garantisce la completa apertura dei contatti. Per la parte di corsa che separa i contatti, deve esistere una zona positiva, escludendo la presenza di elementi resilienti (es. molle) interposti tra i contatti di movimento ed il punto in cui è applicata la forza di azionamento. Il concetto di apertura positiva non è applicabile ai contatti NA.

Gli interruttori di controllo con apertura positiva possono essere dotati di elemento di contatto sia a scatto che lento. Per utilizzare diversi contatti sul medesimo interruttore di controllo con apertura positiva è necessario che questi siano elettricamente separati; se non lo sono, può essere utilizzato un solo contatto.

AZIONAMENTO A SCATTO

I contatti a scatto sono caratterizzati dall'aver una posizione di rilascio non coincidente con quella di azionamento. L'apertura (o chiusura) dei contatti a scatto non è influenzata dalla velocità di azionamento dell'attuatore e fa sì che il comportamento elettrico sia regolare anche in presenza di movimenti molto lenti dell'attuatore.

AZIONAMENTO LENTO

La caratteristica dei contatti ad azione lenta è quella di avere le posizioni di rilascio e di azionamento coincidenti. La velocità di azionamento dell'attuatore, inoltre, influenza direttamente la velocità di scambio dei contatti.

FORZA / COPPIA MINIMA DI AZIONAMENTO

E' la forza / coppia minima che deve essere applicata all'attuatore per produrre lo scambio dei contatti.

FORZA / COPPIA MINIMA DI APERTURA POSITIVA

E' la forza / coppia minima che deve essere applicata all'attuatore per garantire l'apertura positiva sui contatti NC.

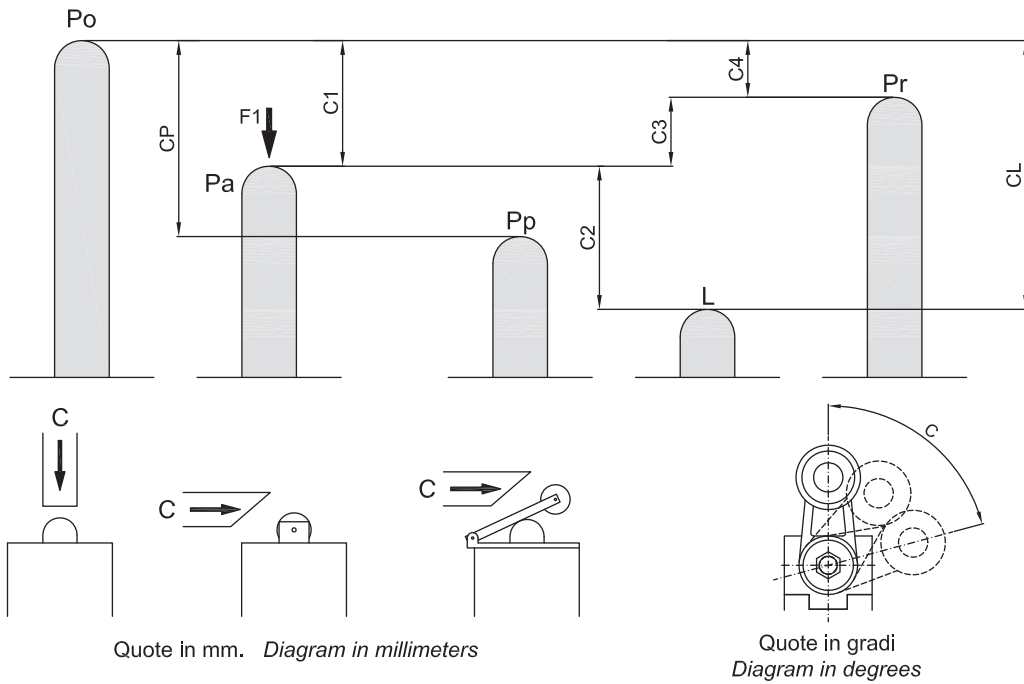

Po Free position

Posizione dell'attuatore quando nessuna forza esterna è applicata.

Pa Operating position

Position of the switch actuator, under the effect of force F1, when the contacts leave their initial free position.

Pp Positive opening position

Position of the switch actuator from which positive opening is ensured.

L Max. travel position

Maximum acceptable travel position of the switch actuator under the effect of a force F1.

Pr Release position

Position of the switch actuator when the contacts return to their initial free position.

C1 Pre-travel

Distance between the free position P0 and the operating position Pa.

Cp Positive opening travel

Minimum travel of the switch actuator, from the free position, to ensure positive opening operation of the normally closed contact.

C2 Max. travel

Distance between the operating position Pa and the max. travel position L.

CL Max. travel

Distance between the free position P0 and the max. travel position L.

C3 Differential travel (C1-C4)

Travel difference of the switch actuator between the operating position Pa and the release position Pr.

C4 Release travel

Distance between the release position Pr and the free position Po.

DIAGRAM FOR SNAP ACTION CONTACTS
CORSE PER CONTATTI A SCATTO

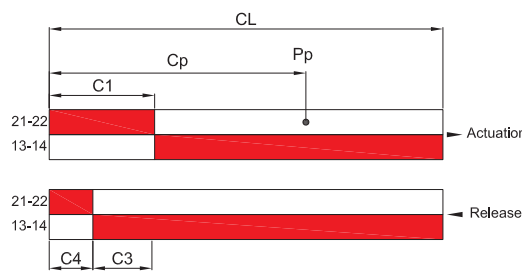
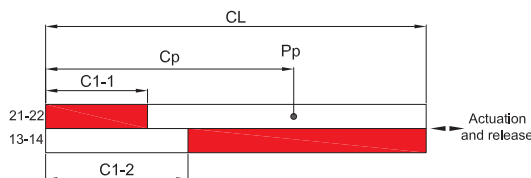

DIAGRAM FOR NON-OVERLAPPING SLOW ACTION CONTACTS
CORSE PER CONTATTI LENTI NON SOVRAPPOSTI



Note - Nota:

for slow action contacts

C3 = 0, C1-2 = pre-travel of contact 21-22,

C1-2 = pre-travel of contact 13-14.

per i contatti di tipo lento:

C3 = 0, C1-1 = pre-corsa dei contatti 21-22,

C1-2 = pre-corsa dei contatti 13-14.



Po Posizione di riposo

Posizione dell'attuatore quando nessuna forza esterna è applicata.

Pa Posizione operativa

Posizione dell'attuatore, con forza F1 applicata, in cui i contatti abbandonano la posizione iniziale di riposo.

Pp Posizione di apertura positiva

Posizione dell'attuatore nel momento in cui interviene l'apertura positiva.

L Posizione di max corsa

Massima corsa raggiungibile dall'attuatore con la forza F1 applicata.

Pr Posizione di rilascio

Posizione dell'attuatore nel momento in cui i contatti sono tornati alla loro posizione di riposo.

C1 Pre-corsa

Distanza che intercorre tra la posizione di riposo P0 e la posizione operativa Pa.

Cp Corsa di apertura positiva

Minima corsa dell'attuatore, dalla posizione di riposo P0, per garantire l'apertura positiva dei contatti NC.

C2 Extra corsa

Distanza che intercorre tra Pa e la corsa massima L.

CL Corsa massima







Distanza che intercorre tra P0 e la corsa massima L.

C3 Corsa differenziale (C1-C4)

Distanza che intercorre tra Pa e Pr.

C4 Corsa di rilascio

Distanza che intercorre tra Pr e Po.

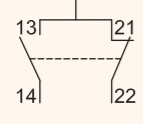
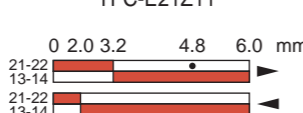
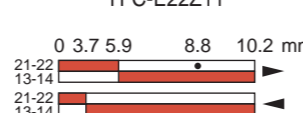
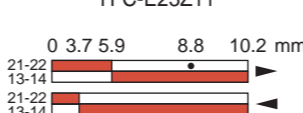
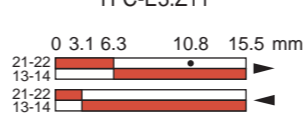
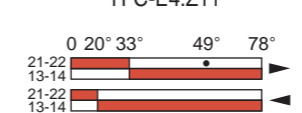
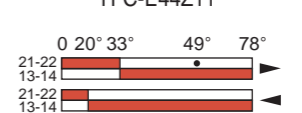
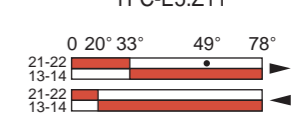
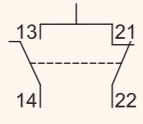
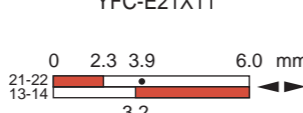
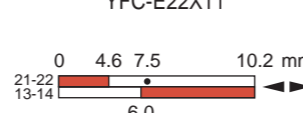
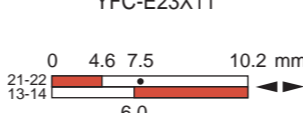
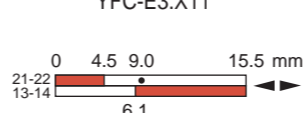
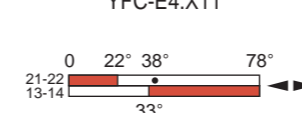
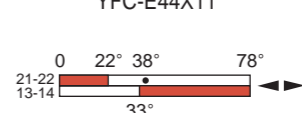
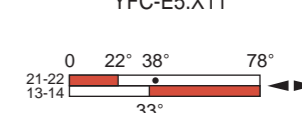
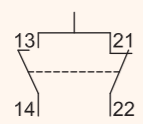
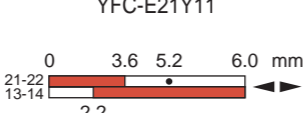
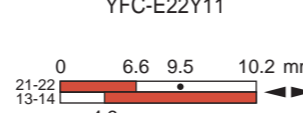
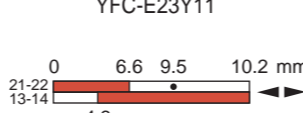
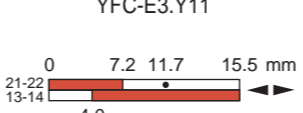
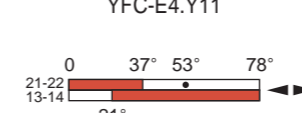
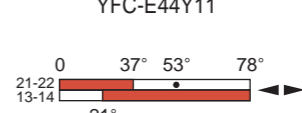
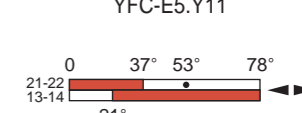
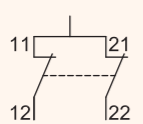
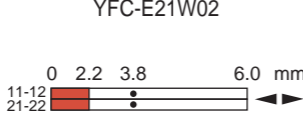
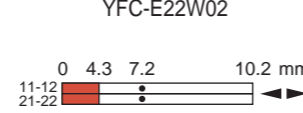
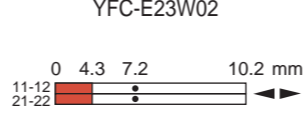
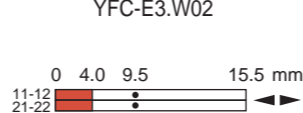
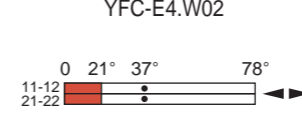
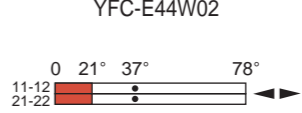
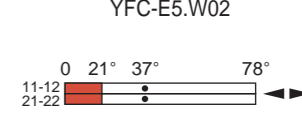
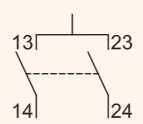
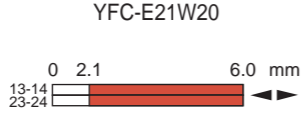
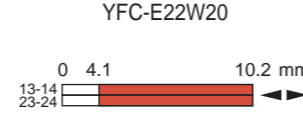
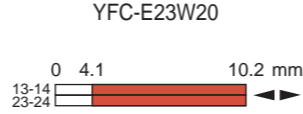
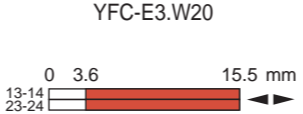
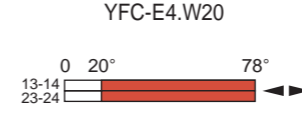
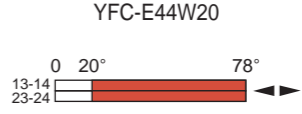
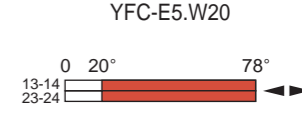
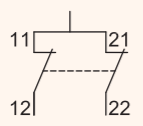
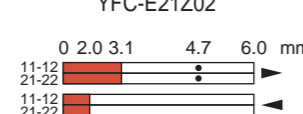
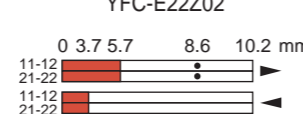
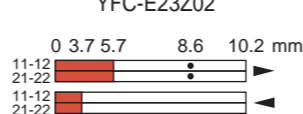
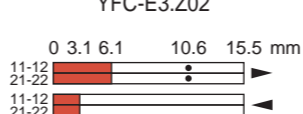
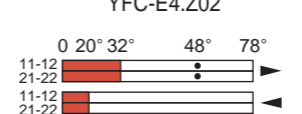
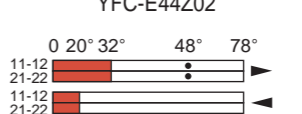
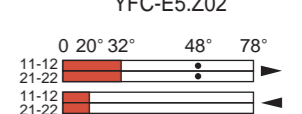
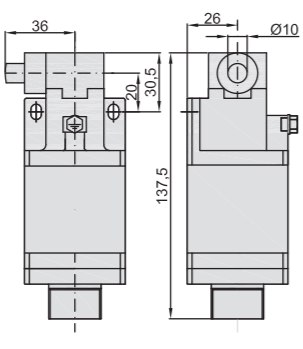
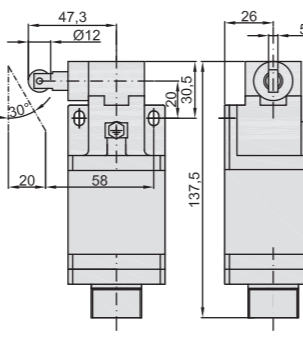
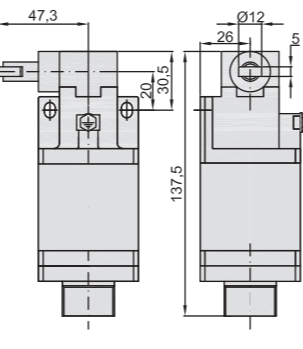
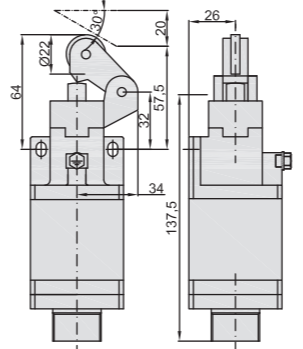
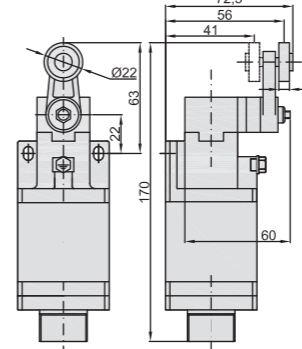
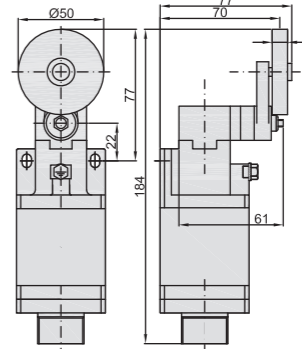
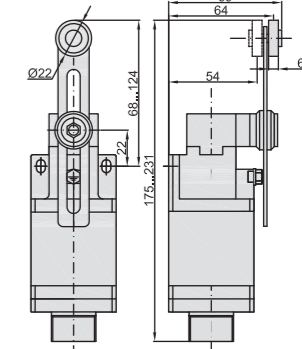







<p>OPERATING HEAD TYPE</p> <p>TIPO DI TESTINA</p>	<p>E21 Stainless steel lateral plain plunger Pistoncino laterale semplice inox</p> 	<p>E22 Stainless steel lateral plunger with Ø12 vertical roller Pistoncino laterale inox con rotella Ø12 verticale</p> 	<p>E23 Stainless steel lateral plunger with Ø12 horizontal roller Pistoncino laterale inox con rotella Ø12 orizzontale</p> 	<p>E3• Ø22 one way lever Leva unidirezionale Ø22 E31: Nylon roller rotella nylon E32: Stainless steel roller rotella inox E33: Steel ball bearing cuscinetto acciaio</p> 	<p>E4• Ø22 roller lever Leva con rotella Ø22 E41: Nylon roller rotella nylon E42: Stainless steel roller rotella inox E43: Steel ball bearing cuscinetto acciaio</p> 	<p>E44 Ø50 rubber roller lever Leva con rotella gomma Ø50</p> 	<p>E5• Adjustable Ø22 roller lever Leva regolabile con rotella Ø22 E51: Nylon roller rotella nylon E52: Stainless steel roller rotella inox E53: Steel ball bearing cuscinetto acciaio</p> 
<p>Max actuator speed [m/s] Velocità max di azionamento [m/s]</p> <p>Min. force or torque of actuation Forza o coppia min. di azionamento</p>	<p>0,5</p> <p>30[N] / 50[Nm]</p>	<p>0,5</p> <p>30[N] / 50[Nm]</p>	<p>0,5</p> <p>30[N] / 50[Nm]</p>	<p>1,5</p> <p>12[N] / 40[Nm]</p>	<p>1,5</p> <p>0,15[N] / 0,30[Nm]</p>	<p>1,5</p> <p>0,15[N] / 0,30[Nm]</p>	<p>1,5</p> <p>0,15[N] / 0,30[Nm]</p>
<p>CONTACT TYPE - TIPO DI CONTATTI</p>							
<p>Z11 Snap action contacts (1NO + 1NC) Contatti a scatto (1NA + 1NC)</p> 	<p>YFC-E21Z11</p> 	<p>YFC-E22Z11</p> 	<p>YFC-E23Z11</p> 	<p>YFC-E3.Z11</p> 	<p>YFC-E4.Z11</p> 	<p>YFC-E44Z11</p> 	<p>YFC-E5.Z11</p> 
<p>X11 Non overlapping slow action contacts (1NO + 1NC) Contatti non sovrapposti ad azione lenta (1NA + 1NC)</p> 	<p>YFC-E21X11</p> 	<p>YFC-E22X11</p> 	<p>YFC-E23X11</p> 	<p>YFC-E3.X11</p> 	<p>YFC-E4.X11</p> 	<p>YFC-E44X11</p> 	<p>YFC-E5.X11</p> 
<p>Y11 Overlapping slow action contacts (1NO + 1NC) Contatti sovrapposti ad azione lenta (1NA + 1NC)</p> 	<p>YFC-E21Y11</p> 	<p>YFC-E22Y11</p> 	<p>YFC-E23Y11</p> 	<p>YFC-E3.Y11</p> 	<p>YFC-E4.Y11</p> 	<p>YFC-E44Y11</p> 	<p>YFC-E5.Y11</p> 
<p>W02 Slow action contacts (2NC) Contatti ad azione lenta (2NC)</p> 	<p>YFC-E21W02</p> 	<p>YFC-E22W02</p> 	<p>YFC-E23W02</p> 	<p>YFC-E3.W02</p> 	<p>YFC-E4.W02</p> 	<p>YFC-E44W02</p> 	<p>YFC-E5.W02</p> 
<p>W20 Slow action contacts (2NO) Contatti ad azione lenta (2NA)</p> 	<p>YFC-E21W20</p> 	<p>YFC-E22W20</p> 	<p>YFC-E23W20</p> 	<p>YFC-E3.W20</p> 	<p>YFC-E4.W20</p> 	<p>YFC-E44W20</p> 	<p>YFC-E5.W20</p> 
<p>Z02 Snap action contacts (2NC) Contatti a scatto (2NC)</p> 	<p>YFC-E21Z02</p> 	<p>YFC-E22Z02</p> 	<p>YFC-E23Z02</p> 	<p>YFC-E3.Z02</p> 	<p>YFC-E4.Z02</p> 	<p>YFC-E44Z02</p> 	<p>YFC-E5.Z02</p> 
<p>DIMENSIONS (mm)</p> <p>DIMENSIONI (mm)</p>							







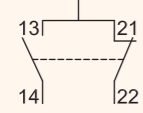
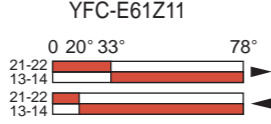
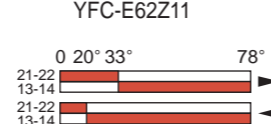
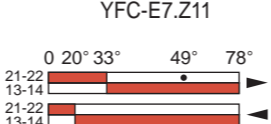
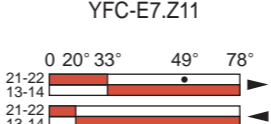
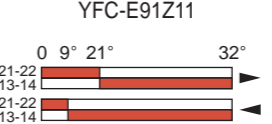
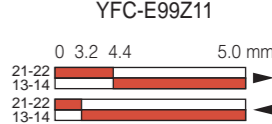
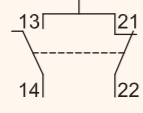
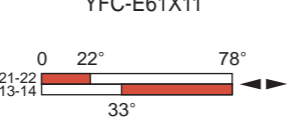
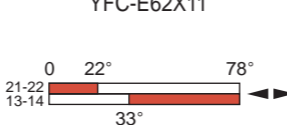
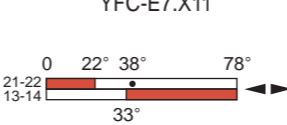
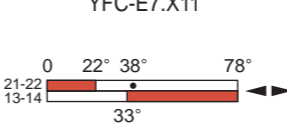
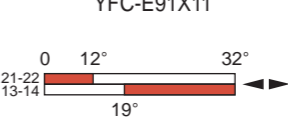
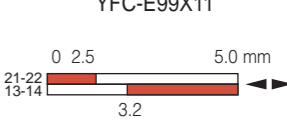
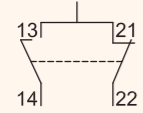
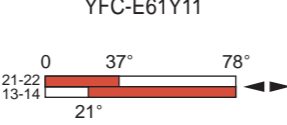
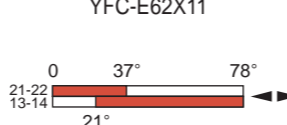
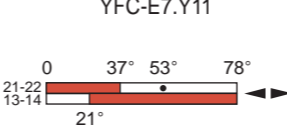
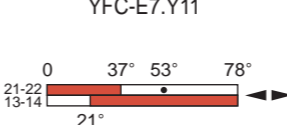
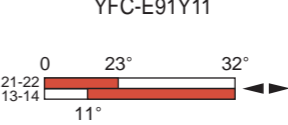
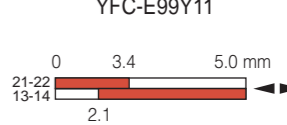
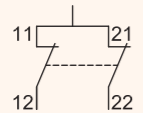
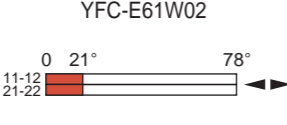

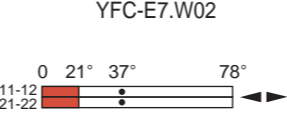
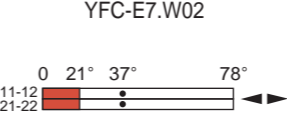
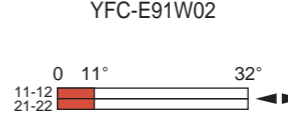
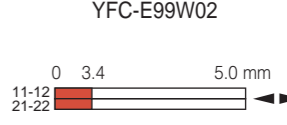
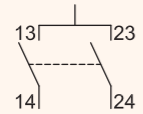
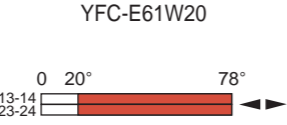
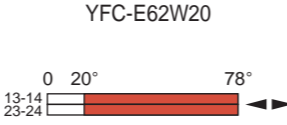
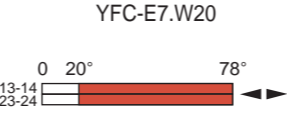
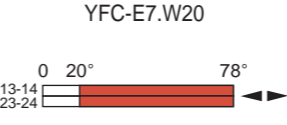
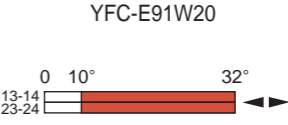
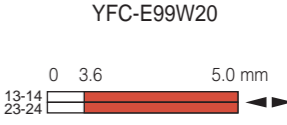
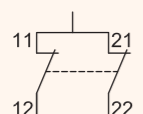
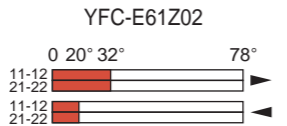
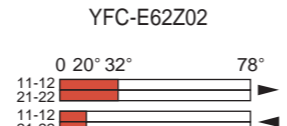
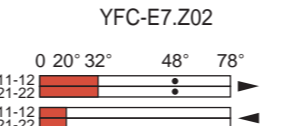
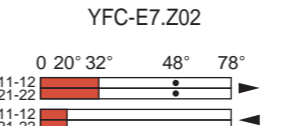
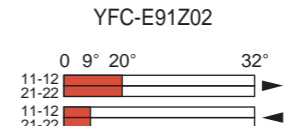
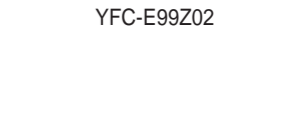
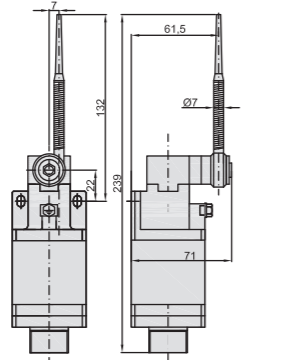
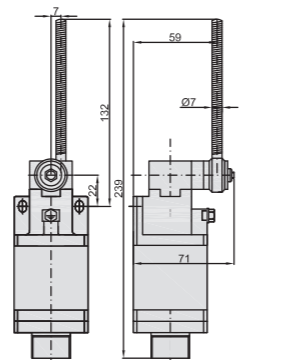
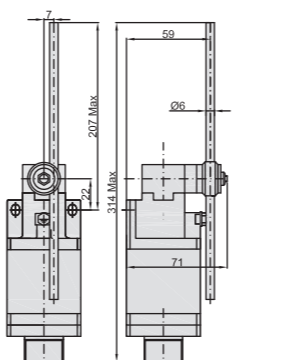
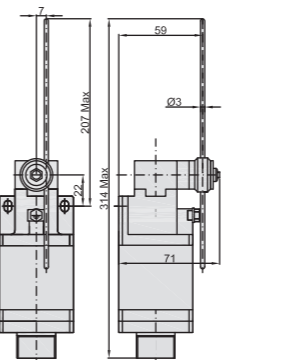
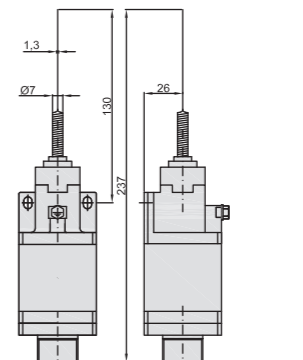
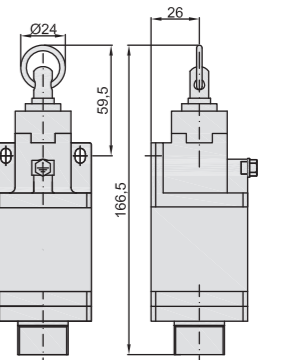
Ex d

Ex d

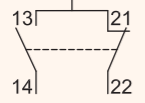
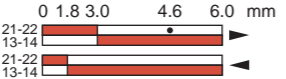
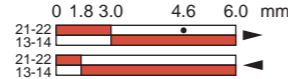
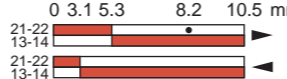
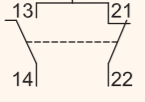
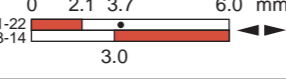
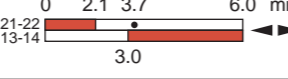
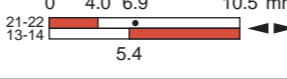
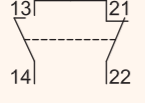
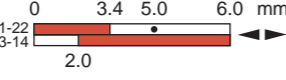
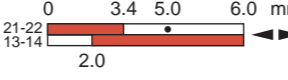
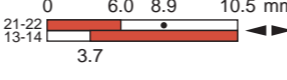
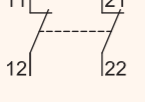
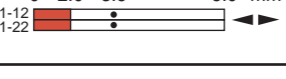
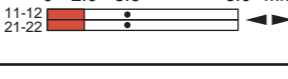
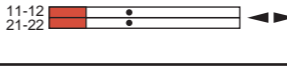
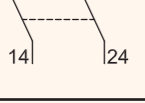
NEW

NEW

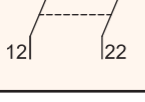
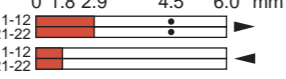
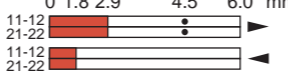
<p>OPERATING HEAD TYPE</p> <p>TIPO DI TESTINA</p>	<p>E61 Nylon actuator with stainless steel spring Attuatore in nylon su molla inox</p> 	<p>E62 Stainless steel spring actuator Attuatore a molla inox</p> 	<p>E7• Adjustable rod lever Asta regolabile E71: Stainless steel rod Ø3 Asta inox E73: Fiberglass rod Ø3 Asta fibra di vetro E75: Square steel rod 3x3 Asta in metallo</p> 	<p>E7• Adjustable rod lever Ø6 Asta regolabile Ø6 E72: Nylon rod asta nylon E74: Fiberglass rod asta fibra di vetro</p> 	<p>E91 Stainless steel spring multidirectional actuator Attuatore multidirezionale a molla inox</p> 	<p>E99 Pull action with ring Con anello a strappo</p> 
<p>Max actuator speed [m/s] Velocità max di azionamento [m/s]</p> <p>Min. force or torque of actuation Forza o coppia min. di azionamento</p>	<p>1,5</p> <p>0,15[N] / -</p>	<p>1,5</p> <p>0,15[N] / -</p>	<p>1,5</p> <p>0,15[N] / 0,30[Nm]</p>	<p>1,5</p> <p>0,15[N] / 0,30[Nm]</p>	<p>1,0</p> <p>0,18[N] / -</p>	<p>0,5</p> <p>25[N] / -</p>
<p>CONTACT TYPE - TIPO DI CONTATTI</p>						
<p>Z11 Snap action contacts (1NO + 1NC) Contatti a scatto (1NA + 1NC)</p> 	<p>YFC-E61Z11</p> 	<p>YFC-E62Z11</p> 	<p>YFC-E7.Z11</p> 	<p>YFC-E7.Z11</p> 	<p>YFC-E91Z11</p> 	<p>YFC-E99Z11</p> 
<p>X11 Non overlapping slow action contacts (1NO + 1NC) Contatti non sovrapposti ad azione lenta (1NA + 1NC)</p> 	<p>YFC-E61X11</p> 	<p>YFC-E62X11</p> 	<p>YFC-E7.X11</p> 	<p>YFC-E7.X11</p> 	<p>YFC-E91X11</p> 	<p>YFC-E99X11</p> 
<p>Y11 Overlapping slow action contacts (1NO + 1NC) Contatti sovrapposti ad azione lenta (1NA + 1NC)</p> 	<p>YFC-E61Y11</p> 	<p>YFC-E62Y11</p> 	<p>YFC-E7.Y11</p> 	<p>YFC-E7.Y11</p> 	<p>YFC-E91Y11</p> 	<p>YFC-E99Y11</p> 
<p>W02 Slow action contacts (2NC) Contatti ad azione lenta (2NC)</p> 	<p>YFC-E61W02</p> 	<p>YFC-E62W02</p> 	<p>YFC-E7.W02</p> 	<p>YFC-E7.W02</p> 	<p>YFC-E91W02</p> 	<p>YFC-E99W02</p> 
<p>W20 Slow action contacts (2NO) Contatti ad azione lenta (2NA)</p> 	<p>YFC-E61W20</p> 	<p>YFC-E62W20</p> 	<p>YFC-E7.W20</p> 	<p>YFC-E7.W20</p> 	<p>YFC-E91W20</p> 	<p>YFC-E99W20</p> 
<p>Z02 Snap action contacts (2NC) Contatti a scatto (2NC)</p> 	<p>YFC-E61Z02</p> 	<p>YFC-E62Z02</p> 	<p>YFC-E7.Z02</p> 	<p>YFC-E7.Z02</p> 	<p>YFC-E91Z02</p> 	<p>YFC-E99Z02</p> 
<p>DIMENSIONS (mm)</p> <p>DIMENSIONI (mm)</p>						

<p>OPERATING HEAD TYPE TIPO DI TESTINA</p>	<p>E11 Stainless steel plain plunger Pistoncino semplice inox</p> 	<p>E12 Stainless steel ball plunger Pistoncino inox con sfera</p> 	<p>E13 Stainless steel Ø12 roller plunger Pistoncino inox con rotella Ø12</p> 
<p>Max actuator speed [m/s] Velocità max di azionamento [m/s] Min. force or torque of actuation Forza o coppia min. di azionamento</p>	<p>0,5 30[N] / 45[Nm]</p>	<p>0,5 30[N] / 45[Nm]</p>	<p>0,5 22[N] / 40[Nm]</p>
<p>CONTACT TYPE - TIPO DI CONTATTI</p>			
<p>Z11 Snap action contacts (1NO + 1NC) Contatti a scatto (1NA + 1NC)</p> 	<p>YFC-E11Z11 0 1.8 3.0 4.6 6.0 mm 21-22 13-14</p> 	<p>YFC-E12Z11 0 1.8 3.0 4.6 6.0 mm 21-22 13-14</p> 	<p>YFC-E13Z11 0 3.1 5.3 8.2 10.5 mm 21-22 13-14</p> 
<p>X11 Non overlapping slow action contacts (1NO + 1NC) Contatti non sovrapposti ad azione lenta (1NA + 1NC)</p> 	<p>YFC-E11X11 0 2.1 3.7 6.0 mm 21-22 13-14</p> 	<p>YFC-E12X11 0 2.1 3.7 6.0 mm 21-22 13-14</p> 	<p>YFC-E13X11 0 4.0 6.9 10.5 mm 21-22 13-14</p> 
<p>Y11 Overlapping slow action con- tacts (1NO + 1NC) Contatti sovrapposti ad azione lenta (1NA + 1NC)</p> 	<p>YFC-E11Y11 0 3.4 5.0 6.0 mm 21-22 13-14</p> 	<p>YFC-E12Y11 0 3.4 5.0 6.0 mm 21-22 13-14</p> 	<p>YFC-E13Y11 0 6.0 8.9 10.5 mm 21-22 13-14</p> 
<p>W02 Slow action contacts (2NC) Contatti ad azione lenta (2NC)</p> 	<p>YFC-E11W02 0 2.0 3.6 6.0 mm 11-12 21-22</p> 	<p>YFC-E12W02 0 2.0 3.6 6.0 mm 11-12 21-22</p> 	<p>YFC-E13W02 0 3.7 6.6 10.5 mm 11-12 21-22</p> 
<p>W20 Slow action contacts (2NO) Contatti ad azione lenta (2NA)</p> 	<p>YFC-E11W20 0 1.9 6.0 mm 13-14 23-24</p> 	<p>YFC-E12W20 0 1.9 6.0 mm 13-14 23-24</p> 	<p>YFC-E13W20 0 3.5 10.5 mm 13-14 23-24</p> 
<p>Z02 Snap action contacts (2NC) Contatti a scatto (2NC)</p> 	<p>YFC-E11Z02 0 1.8 2.9 4.5 6.0 mm 11-12 21-22</p> 	<p>YFC-E12Z02 0 1.8 2.9 4.5 6.0 mm 11-12 21-22</p> 	<p>YFC-E13Z02 0 3.1 5.1 8.0 10.5 mm 11-12 21-22</p> 
<p>DIMENSIONS (mm) DIMENSIONI (mm)</p>	