

Equilibratrici automatiche
per pulegge

Automatic balancing machines
for pulleys

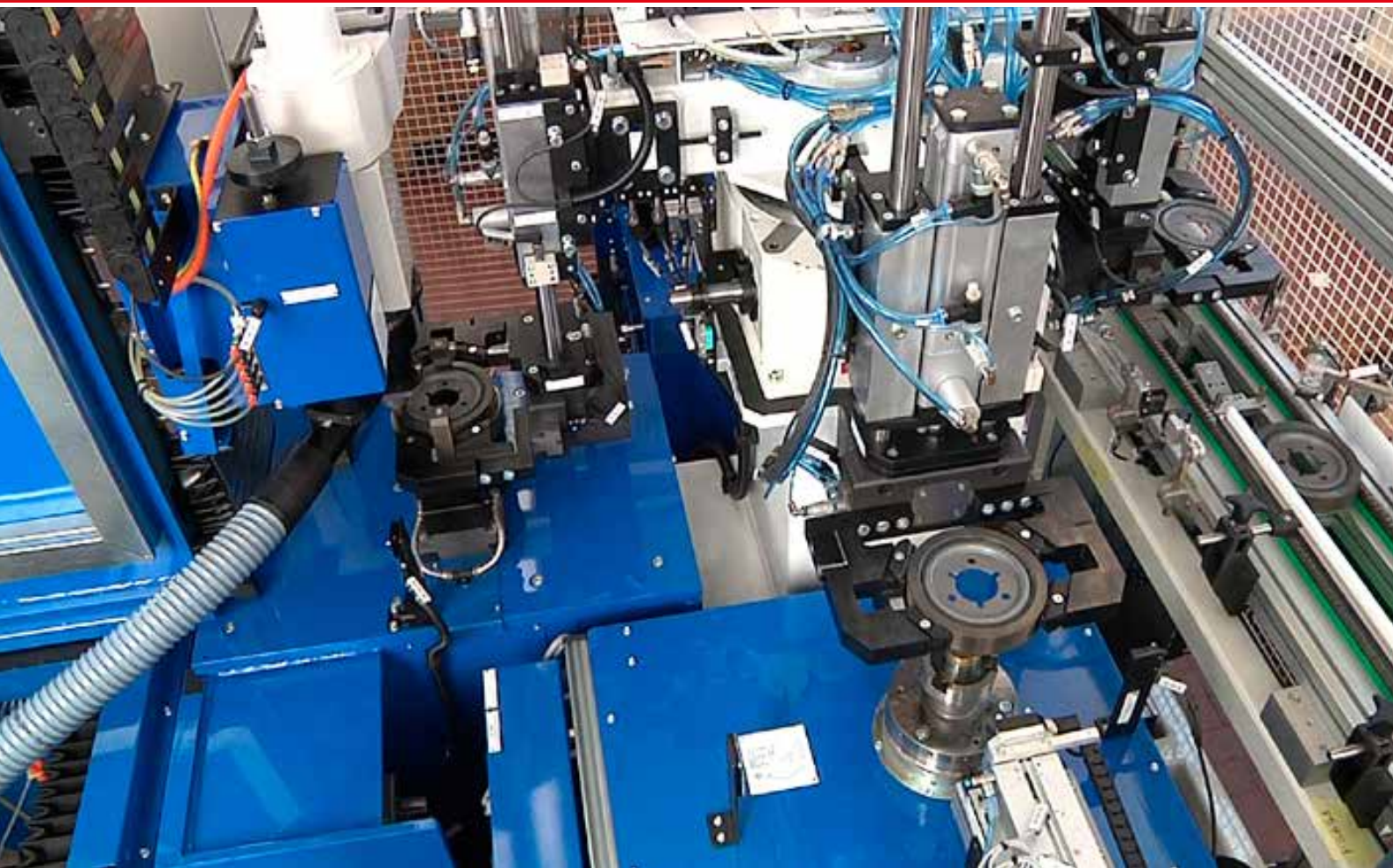

The pieces shown on the picture are property of Metaldyne France: all rights reserved.



CEMB

BALANCING MACHINES



Equilibratrici monostazione One station balancing machines



VUBK50/UF-P

Versione base con foratrice elettropneumatica. Sull'unità è montata una testina che permette una doppia foratura in simultanea completa di bloccaggi radiali. (opzionale).

Basic model equipped with electro-pneumatic drilling unit. The drilling unit spindle is equipped with a special device that includes a twin-drill bit and automatic operation with simultaneous radial clamping action (optional).

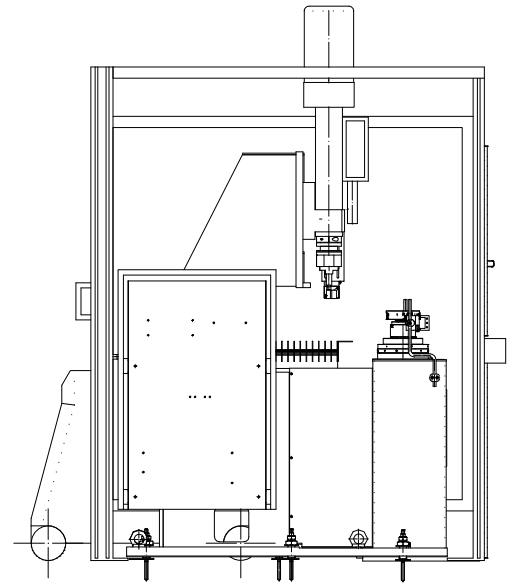

VUBK50/UF/A

Versione automatica. La profondità della foratura è controllata da un motore asse. Monopunta o doppia punta (opzionale). Tempo di ciclo più breve rispetto a versione elettropneumatica. Cambio automatico del raggio di correzione.

Automatic version. The drilling depth is managed by a controlled axis motor. Single-drill bit or twin drill bit (option). Lower cycle time compared with the electro-pneumatic version. Automatic selection of the correction radius.

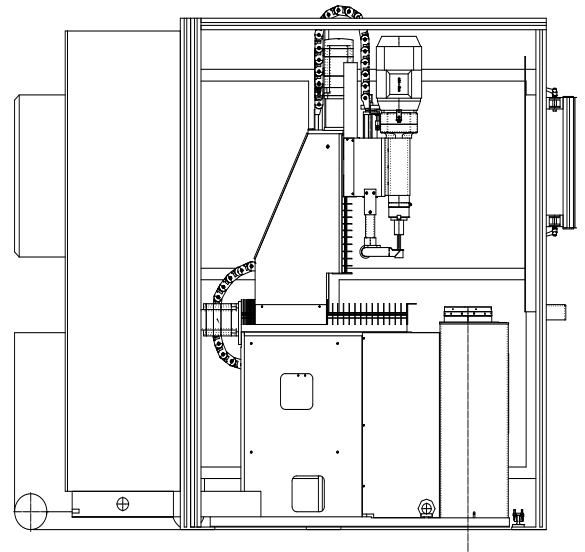

VEBK100/UF-A/UFO

Versione con misura squilibrio dinamico e correzione su 2 piani con una unità di foratura verticale e una orizzontale, completa di reazioni pneumo-idrauliche.

Model designed for measuring and the correction on 2 planes of dynamic unbalance, achieved by vertical and horizontal drilling units with pneumatic and hydraulic reaction devices.

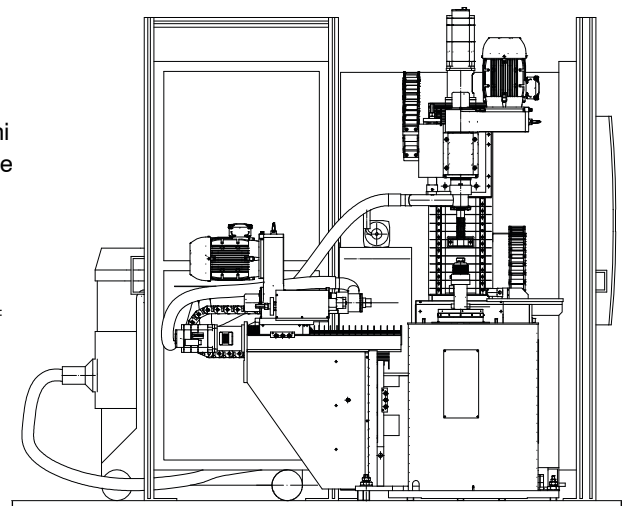



VUBK50/UFA/TG

Versione per correzione tramite foratura o fresatura. Il pezzo viene staffato alla tavola rotante con dispositivi idraulici.

Model designed for the unbalance correction by drilling or milling operation. The part is clamped to the rotary table by a hydraulic clamping devices.

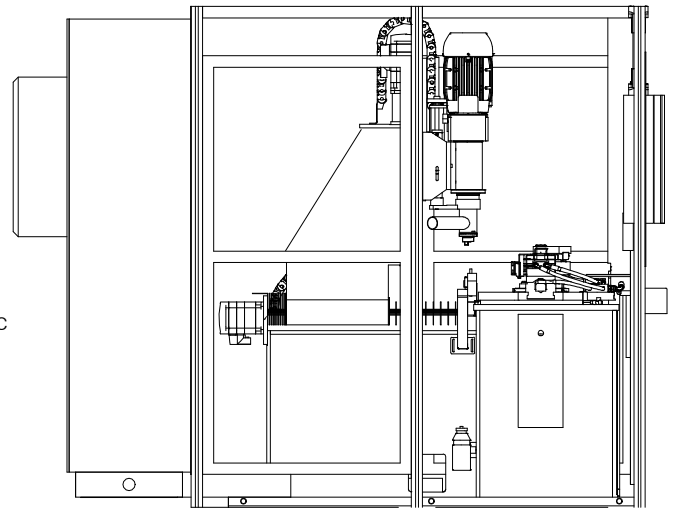

The pieces shown on the picture are property of Metaldyne France: all rights reserved.



VUBK50/UFA/CN

Versione automatica, 3 assi controllati. Correzione per foratura o fresatura a pezzo fisso tramite movimenti assi interpolati. Dispositivo integrato di reazione foratura.

Automatic version with 3 controlled axes. Correction achieved with the rotor clamped in position and by drilling or milling with interpolated axes movements and an integrated drilling reaction device.

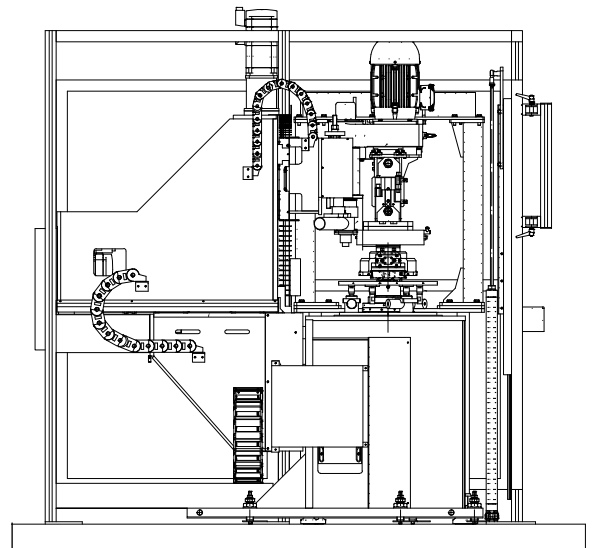

VUBK50/UF-A/1ST

Impianto automatico con singola stazione di misura e correzione squilibrio statico mediante unità di foratura ad asse controllato. Caricatore lineare alza e sposta con 2 pinze pneumatiche parallele. Trasportatori a catene motorizzate per ingresso e uscita pezzi.

Automatic balancing system with independant measuring and correction station. Correction of the static unbalance is achieved by a controlled axis drilling unit. A linear loader pickups and releases the parts by parallel pneumatic grippers. Powered chain input and output conveyors for loading and unloading parts.



Equilibratrici più stazioni e caricatore

Multi-stations balancing machines with loader

VUBK30/UF-A/2ST

Impianto automatico a due stazioni completo di caricatore rotativo a due bracci a 180°. Composto da stazione di misura/controllo più stazione di correzione e rulliere di ingresso/uscita pezzi con correzione automatica dello squilibrio statico mediante unità di foratura a due assi controllati.

Automatic twin-stations balancing system equipped with 180° double arm loader and composed by measuring/control station, correction station and input conveyors. Parts output with automatic correction of the static unbalance obtained by a double controlled axes drilling unit.



VUBK50/UF/CN/4ST

Impianto automatico a quattro stazioni completo di caricatore rotativo a quattro bracci a 90°. Composto da stazione prelievo/scarico, misura, correzione, controllo e rulliere di ingresso/uscita pezzi. Correzione automatica dello squilibrio statico mediante unità di foratura/fresatura.

Automatic four-station balancing system equipped with 90° four-arm rotary loader and composed of load/unload station, measuring station, correction station, control station, input/output conveyors and with automatic correction of the static unbalance obtained by a drilling/milling unit.

Legenda - legend

- ① carico/scarico - loading/unloading station
- ② misura - measuring station
- ③ correzione - correction station
- ④ controllo - control station

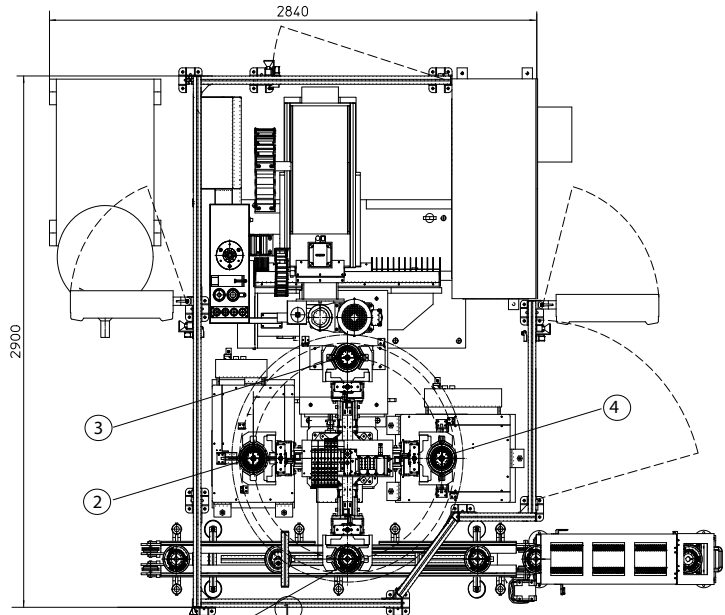

See front picture

APPLICAZIONI SPECIALI: SPECIAL APPLICATIONS:

Dispositivo per il controllo delle misure dimensionali effettuate tramite un'apparecchiatura ottica. Viene eseguito il controllo su una quota assoluta e sul run-out radiale e laterale.

Control unit for the geometrical dimensions received by an optical equipment. The control is performed on an quote on the "V" slots and on the lateral and radial run-out.



CEMB S.p.A.
Via Risorgimento, 9
23826 MANDELLO DEL LARIO (LC) Italy
www.cemb.com

CEMB HOFMANN UK
www.cembhofmann.co.uk

CEMB SHANGHAI OFFICE
www.cemb.com.cn

CEMB USA BL Systems Inc.
www.cemb-usa.com

Industrial balancing division:
phone +39 0341 706111
fax +39 0341 735678
Italy e-mail: industry.it@cemb.com
Export e-mail: industry@cemb.com



Address: Unit 6, No. 52, Jouybar St.
Tehran - 1415795361, IRAN
Tel: +98-21-88996358-60 Fax: +98-21-88992367
www.cemb-iran.com
info@cemb-iran.com