

FF Pressure Switch



FF Pressure Switch

Diaphragm and piston switches

Product informations

The new FF pressure switch design is based on 40 years of know-how and is an example for consequent quality oriented development. The ingenious construction without linkages or pivot points and with only a few moving parts has many excellent features.

Designed for modern manufacturing with automation, this new FF pressure switch will also be economically a good choice because it's construction is designed for the future.

Considering the many customer applications, this new switch has the same mounting bracket configuration and therefore can successfully replace our earlier FF4 pressure switch.

Pressure measuring system

A force balance measuring system contains an elastomere diaphragm, pressure plate and a counteracting adjustable spring load. The pressure plate and spring are connected with a pushrod, the resulting movement is transferred to the Micro Switch by a stainless steel leaf spring actuator. The pressure setpoint is adjusted for increasing or decreasing pressure operations by rotating the hex plug on top of the unit. The standard FF pressure switch features a Micro Switch with an adjustment knob and scale to adjust the hysteresis (deadband). As option there are Micro Switches with a fixed hysteresis which will reduce the adjustment work considerably. Various sizes of pressure plates and springs offer up to six standard pressure ranges. Diaphragms are available in Buna, EPDM and Teflon.

Switching element

The snap-action instrument quality Micro Switches have a SPDT (single pole double throw) mode. The standard version has an adjustment knob to adjust the hysteresis. The M- and H-switches are not adjustable and offer a fixed hysteresis. Optional is the Micro Switch manual reset for safety related shut-down systems.

The standard contact material is fine silver; as an option, gold plated contact material can be specified for those applications where low DC voltages are used.

Enclosure

The enclosure, a copper free aluminium housing and a transparent cover, is very rugged and corrosion resistant also for sea water environment. The transparent cover allows a quick visual check at all times and includes a tamperproof feature. The standard enclosure version with a rubber grommet cable entry has an IP54 protection code, an IP65 (Nema 4) protection code is available.

This new FF pressure switch has a mounting feature at the bottom of the housing. Size and dimensions of the mounting bracket will allow an easy retrofit with the FF4 (earlier) pressure switches from Entrellec-Fanal.



FF Pressure Switches

- Very little movement of sensing element, long life rate
- Measuring system without friction, no wear or tear: no scheduled maintenance needed
- Micro Switch with instrument quality, precise set point repeatability
- Adjustments of set point and hysteresis (dead band) are individual without interference and therefore quick and simple
- Rugged construction, high material quality, fine silver or gold plated contact material
- Various approvals available

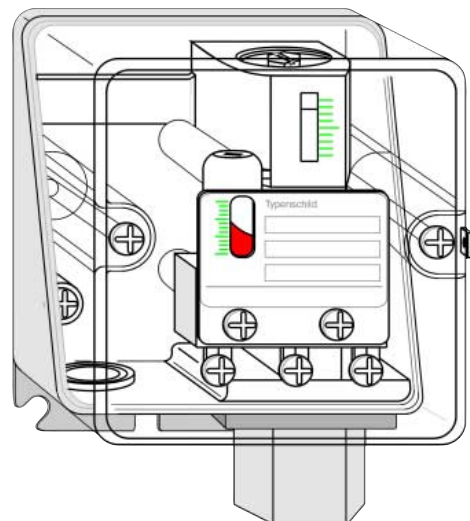

FF Pressure Switch

Diaphragm and piston switches



Applications

This new switch generation is designed for industrial and utility installations for ashore and maritime applications. Main applications with the adjustable deadband are: pump- and compressor controls, for pressurised systems such as accumulator or sprinkler systems etc. The switches with fixed deadbands are designed for high or low alarm and shut-off functions such as dry-run pump protection, low or high pressure warnings etc.

The Micro Switch with manual reset is used for safety related shut-down systems where an inspection on site by operation personnel is mandatory. For pulsating pressures we advise to order the units with a pressure inlet restrictor (snubber) with 0,5 mm bore. These FF switches are not designed for nuclear or aeronautical applications.

Installation and comissioning

The switches can be mounted in any position, however, we recommend to install the units vertically with the pressure and electrical pointing downward. The unit can be directly mounted on the pressure port or mounted to a wall by using the mounting bracket at the bottom of the housing. When mounted in a mobile or maritime application, the connection tubing should be installed with fixtures at a distance of max. 50 cm.

The electrical connection is made directly onto the terminals at the Micro Switch or optional separate terminal block. When using the rubber grommet to enter the cable the wire strap should be tightened as cable arrester. Our IP 65 cable gland has a built-in cable arrester feature.

To adjust the setpoint and or hysteresis, the cover must be removed. For precise settings the use of a test rig or manometer is recommended; the scales in the switch are for orientation only. The bottom of the plug and the "slope marking" on the hysteresis knob are the reference mark for the scale reading.

At lower pressure ranges the set point may drift when the unit is mounted in a different position than it has been adjusted for. After the installation and/or settings are completed, the transparent cover must be replaced at all times. Because of the small tolerances of the cover and housing please ensure to position the cover over the bottom end of the housing before you close the top part and tighten the screws securely.

Note: Before installation please verify that the ambient media and operating conditions are in accordance with our technical data bulletins, and refer to the technical instructions supplied with each unit to avoid switch failures, to ensure safety for personnel, and to avoid property damage.

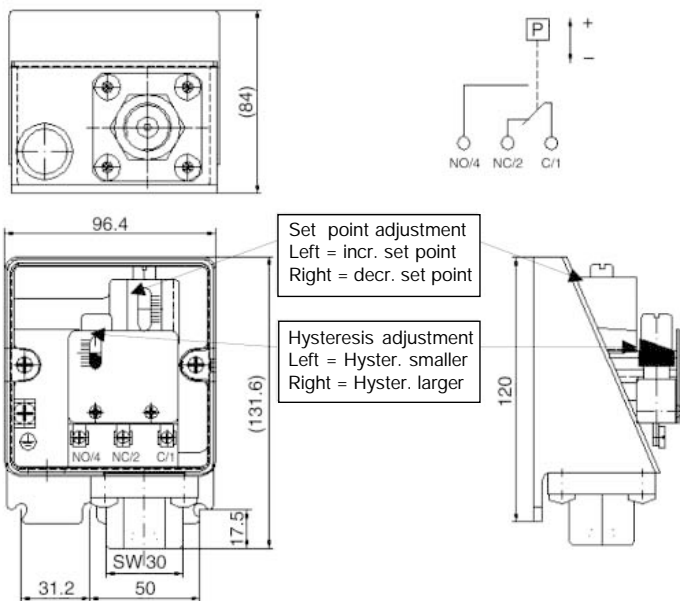

Diaphragm switch

FF 1	0,3 – 1,5 bar
FF 6	1 – 6 bar
FF 10	1 – 10 bar
FF 16	2,5 – 16 bar
FF 40	6 – 40 bar

Piston switch

FF 160	20 - 160 bar
FF 300	30 - 300 bar

Pressure switch FF 1...40

Diaphragm switches



Characteristics

The FF pressure switch can be used for both pressure monitoring and control tasks. If the pressure at the compressed air supply reaches the set point, the micro switch closes the normally open contact 1-4, and the normally closed contact is opened. Contact 1-2 is not closed until the pressure has dropped by the set hysteresis value. Set point and hysteresis may be adjusted independently of one another, the scales only serving for orientation. A precise adjustment is only possible with suitable test equipment (e.g. a manometer).

- 5 pressure ranges up to 40 bar
- adjustment of set point and hysteresis
- high set point repeatability
- 1 SPDT contact, optionally with gold plated contacts
- robust housing
- Approvals on request: FM

Ordering details

Type	Pressure range	Order No.
FF- 1-G ^{3/8}	0,3 - 1,5 bar	F 013601 000
FF- 6-G ^{3/8}	1 - 6 bar	F 013602 000
FF- 10-G ^{3/8}	1 - 10 bar	F 013606 000
FF- 16-G ^{3/8}	2,5 - 16 bar	F 013603 000
FF- 40-G ^{3/8}	6 - 40 bar	F 013604 000

Technical Data

Process connection

Fitting	Alu die castings, material 230, resistant to seawater
Connection thread	G3/8", optional: G1/2", G1/4"
Diaphragm material	Perbunan, optional: Viton, Teflon
Working pressure max.	40 bar
Proof pressure	60 bar

Standard micro switch (with a adjustable hysteresis)

Operating voltage (AC) max.	480 V
Operating current (bei 250V AC)	15 A
Operating current (bei 480V AC)	6 A
Operating voltage (DC) max.	125 V
Operating current (bei 24V DC)	5 A
Operating current (bei 125V DC)	0,4 A

Micro switch with gold-plated contacts

Operating voltage (AC) max.	125 V
Operating current (bei 125V AC)	1 A
Operating voltage (DC) max.	24 V
Operating current (bei 24V DC)	1 A

Micro switch with manual reset

Operating voltage (AC) max.	480 V
Operating current (bei 250V AC)	10 A
Operating current (bei 480V AC)	3 A
Operating voltage (DC) max.	125 V
Operating current (bei 125V DC)	1 A (0,5 A at fixed hysteresis)
Operating current (bei 125V DC)	0,4 A

Enclosure

Material under part	Alu die casting Material 230, resistant to seawater
Transparent cover	Polycarbonate (Makrolon) with injection-moulded seal
Dimensions: Height / Width/ Depht	131,5mm / 96,2mm / 87mm
Cable entry (standard)	Rubber grommet
IP 65 version	Cable gland M20*1,5
Cable arrestor	Cable tie (Polyamide)

General data

Weight	ca. 0,8kg
Ambient temperature limits	-30...+70°C
Switching frequency	1800 / h
Vibration	2...15Hz
Amplitude	+/-1,6mm, 25...100Hz, 4g

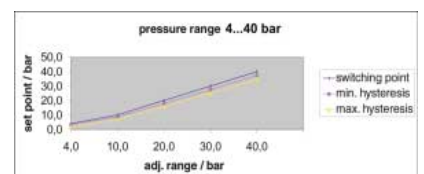
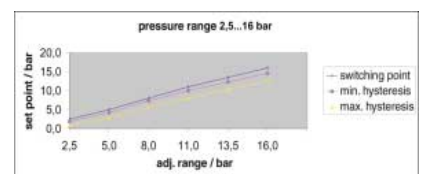
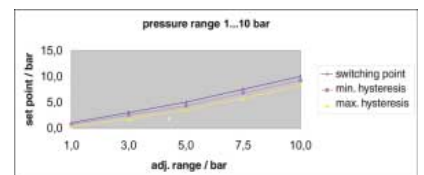
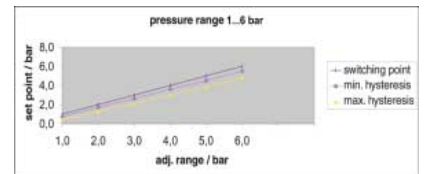
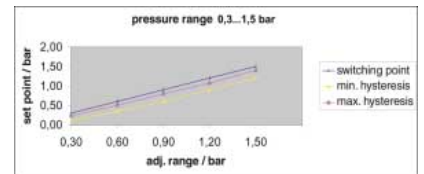



Pressure switch FF 160 + FF 300

Piston switches



Characteristics

The FF pressure switch can be used for both pressure monitoring and control tasks. If the pressure at the compressed air supply reaches the set point, the micro switch closes the normally open contact 1-4, and the normally closed contact is opened. Contact 1-2 is not closed until the pressure has dropped by the set hysteresis value. Set point and hysteresis may be adjusted independently of one another, the scales only serving for orientation. A precise adjustment is only possible with suitable test equipment (e.g. a manometer).

- 2 pressure ranges up to 300 bar
- adjustment of set point and hysteresis
- high set point repeatability
- 1 SPDT contact; gold plated contacts optional
- robust housing
- Approvals on request:   FM

Ordering details

Type	Pressure range	Order No.
FF-160-G ³ / ₈	20 - 160 bar	F 013607 000
FF-300-G ³ / ₈	30 - 300 bar	F 013605 000

Technical data

Process connection

Fitting	Alu die castings, material 230, resistant to seawater
Connection thread	G3/8", optional: G1/2", G1/4"
Diaphragm material	PA 6.6 with Perbunan O-ring
Working pressure max.	300 bar
Proof pressure	450 bar

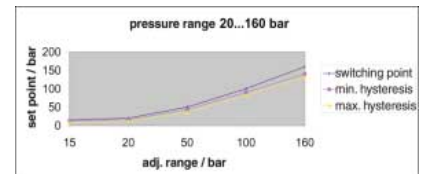

Standard micro switch (with a adjustable hysteresis)

Operating voltage (AC) max.	480 V
Operating current (bei 250V AC)	15 A
Operating current (bei 480V AC)	6 A
Operating voltage (DC) max.	125 V
Operating current (bei 24V DC)	5 A
Operating current (bei 125V DC)	0,4 A

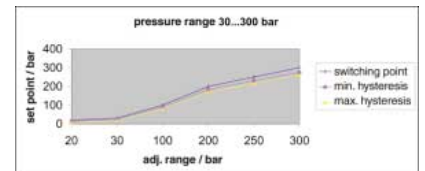

Micro switch with gold-plated contacts

Operating voltage (AC) max.	125 V
Operating current (bei 125V AC)	1 A
Operating voltage (DC) max.	24 V
Operating current (bei 24V DC)	1 A

Micro switch with manual reset

Operating voltage (AC) max.	480 V
Operating current (bei 250V AC)	10 A
Operating current (bei 480V AC)	3 A
Operating voltage (DC) max.	125 V
Operating current (bei 125V DC)	1 A (0,5 A at fixed hysteresis)
Operating current (bei 125V DC)	0,4 A

Enclosure

Material under part	Alu die casting Material 230, resistant to seawater
Transparent cover	Polycarbonate (Makrolon) with injection-moulded seal
Dimensions: Height / Width/ Depth	131,5mm / 96,2mm / 87mm
Cable entry (standard)	Rubber grommet
IP 65 version	Cable gland M20*1,5
Cable arrestor	Cable tie (Polyamide)

General data

Weight	ca. 0,8kg
Ambient temperature limits	-30...+70°C
Switching frequency	1800 / h
Vibration	2...15Hz
Amplitude	+/-1,6mm, 25...100Hz, 4g

Pressure switch FF 1...16 VdS

Diaphragm switches, VdS approved



Characteristics

The FF pressure switch can be used for both pressure monitoring and control tasks. If the pressure at the compressed air supply reaches the set point, the micro switch closes the normally open contact 1-4, and the normally closed contact is opened. Contact 1-2 is not closed until the pressure has dropped by the set hysteresis value. Set point and hysteresis may be adjusted independently of one another, the scales only serving for orientation. A precise adjustment is only possible with suitable test equipment (e.g. a manometer).

- FF 1, 6, 16-...VdS have been approved by the German VdS (*Verband der Sachversicherer*: German Insurance Association) for the use in stationary waterextinguishing installations.
- 3 pressure ranges up to 16 bar
- adjustment of set point and hysteresis
- high set point repeatability
- 1 SPDT contact, optionally with gold plated contacts
- robust housing
- Approvals: VdS

Ordering details

Type	Pressure range	Order No.
FF- 1-G ^{1/2} -VdS	0,3 - 1,5 bar	F 013601 104
FF- 1-G ^{1/2} -RH-VdS	0,3 - 1,5 bar	F 013601 124
FF- 1-G ^{1/2} -M-VdS	0,3 - 1,5 bar	F 013601 144
FF- 6-G ^{1/2} -VdS	1 - 6 bar	F 013602 104
FF- 6-G ^{1/2} -RH-VdS	1 - 6 bar	F 013602 124
FF- 6-G ^{1/2} -M-VdS	1 - 6 bar	F 013602 144
FF- 16-G ^{1/2} -VdS	2,5 - 16 bar	F 013603 104

Technical data

Process connection

Fitting Alu die castings, material 230, resistant to seawater

Connection thread G^{1/2}" , G^{3/8}" optional
 Diaphragm material Perbunan
 Working pressure max. 40 bar
 Proof pressure 60 bar

Standard micro switch (with a adjustable hysteresis)

Operating voltage (AC) max. 480 V
 Operating current (bei 250V AC) 15 A
 Operating current (bei 480V AC) 6 A
 Operating voltage (DC) max. 125 V
 Operating current (bei 24V DC) 5 A
 Operating current (bei 125V DC) 0,4 A

Micro switch with manual reset

Operating voltage (AC) max. 480 V
 Operating current (bei 250V AC) 10 A
 Operating current (bei 480V AC) 3 A
 Operating voltage (DC) max. 125 V
 Operating current (bei 125V DC) 1 A (0,5 A at fixed hysteresis)
 Operating current (bei 125V DC) 0,4 A

Enclosure

Material under part Alu die casting
 Material 230,
 resistant to seawater
 Transparent cover Polycarbonate (Makrolon)
 with injection-moulded seal
 Dimensions: Height / Width/ Depht 131,5mm / 96,2mm / 87mm
 IP 65 version Cable gland M20*1,5
 Cable arrestor Cable tie (Polyamide)

General data

Weight ca. 0,8kg
 Ambient temperature limits -30...+70°C
 Switching frequency 1800 / h
 Vibration 2...15Hz
 Amplitude +/-1,6mm, 25...100Hz, 4g

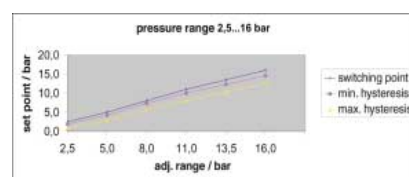
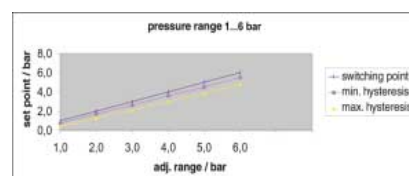
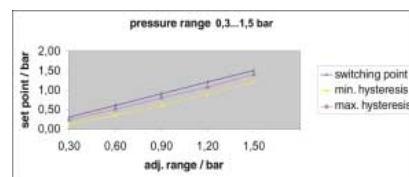

Pressure switch FF 1...300 GL

Diaphragm and Piston switches, GL certified



Characteristics

The FF pressure switch can be used for both pressure monitoring and control tasks. If the pressure at the compressed air supply reaches the set point, the micro switch closes the normally open contact 1-4, and the normally closed contact is opened. Contact 1-2 is not closed until the pressure has dropped by the set hysteresis value. Set point and hysteresis may be adjusted independently of one another, the scales only serving for orientation. A precise adjustment is only possible with suitable test equipment (e.g. a manometer).

- 7 pressure ranges up to 300 bar
- adjustment of set point and hysteresis
- high set point repeatability
- 1 SPDT contact; gold plated contacts optional
- robust housing
- Approvals: Ⓢ

Ordering details

Type	Pressure range	Order No.
FF- 1-G ³ / ₈ -GL	0,3 - 1,5 bar	F 013601 003
FF- 6-G ³ / ₈ -GL	1 - 6 bar	F 013602 003
FF- 10-G ³ / ₈ -GL	1 - 10 bar	F 013606 003
FF- 16-G ³ / ₈ -GL	2,5 - 16 bar	F 013603 003
FF- 40-G ³ / ₈ -GL	6 - 40 bar	F 013604 003
FF- 160-G ³ / ₈ -GL	20 - 160 bar	F 013607 003
FF- 300-G ³ / ₈ -GL	30 - 300 bar	F 013605 003

Technical data

Process connection

Fitting	Alu die castings, material 230, resistant to seawater G3/8", optional: G1/2"
Connection thread	Perbunan, optional: Viton, Teflon
Diaphragm material	diaphragm: 40 bar, piston: 300 bar
Working pressure max.	diaphragm: 60 bar, piston: 450 bar
Proof pressure	

Standard micro switch (with a adjustable hysteresis)

Operating voltage (AC) max.	480 V
Operating current (bei 250V AC)	15 A
Operating current (bei 480V AC)	6 A
Operating voltage (DC) max.	125 V
Operating current (bei 24V DC)	5 A
Operating current (bei 125V DC)	0,4 A

Micro switch with gold-plated contacts

Operating voltage (AC) max.	125 V
Operating current (bei 125V AC)	1 A
Operating voltage (DC) max.	24 V
Operating current (bei 24V DC)	1 A

Micro switch with manual reset

Operating voltage (AC) max.	480 V
Operating current (bei 250V AC)	10 A
Operating current (bei 480V AC)	3 A
Operating voltage (DC) max.	125 V
Operating current (bei 125V DC)	1 A (0,5 A at fixed hysteresis)
Operating current (bei 125V DC)	0,4 A

Enclosure

Material under part	Alu die casting Material 230, resistant to seawater
Transparent cover	Makrolon UL-V0, self-extinguishing with injection-moulded seal
Dimensions: Height / Width/ Depth	131,5mm / 96,2mm / 87mm
IP 65 version	Cable gland M20*1,5
Cable arrestor	Cable tie (Polyamide)

General data

Weight	ca. 0,8kg
Ambient temperature limits	-30...+70°C
Switching frequency	1800 / h
Vibration	2...15Hz
Amplitude	+/-1,6mm, 25...100Hz, 4g

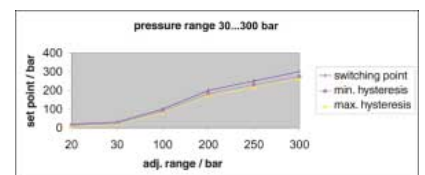
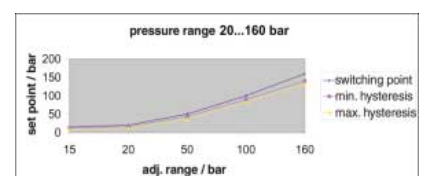
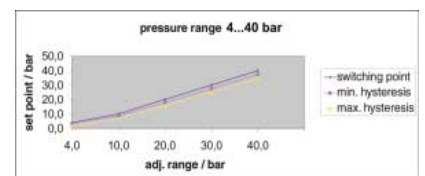
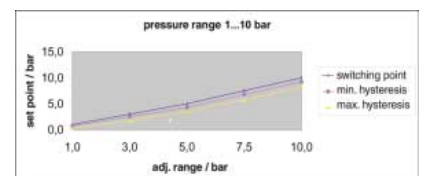
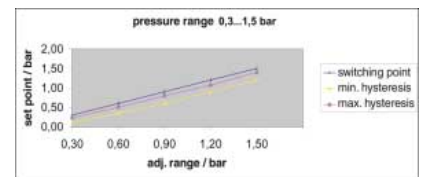

Pressure switch FF 1...40 K

Diaphragm switches, with plastic fittings



Characteristics

The FF pressure switch can be used for both pressure monitoring and control tasks. If the pressure at the compressed air supply reaches the set point, the micro switch closes the normally open contact 1-4, and the normally closed contact is opened. Contact 1-2 is not closed until the pressure has dropped by the set hysteresis value. Set point and hysteresis may be adjusted independently of one another, the scales only serving for orientation. A precise adjustment is only possible with suitable test equipment (e.g. a manometer).

- especially suitable for usage in wet conditions
- all parts that get in contact with the surrounding media are made in plastic
- 5 pressure ranges up to 40 bar
- adjustment of set point and hysteresis
- high set point repeatability
- 1 SPDT contact, optionally with gold plated contacts
- robust housing

Ordering details

Type	Pressure range	Order No.
FF- 1-G ^{3/8} -K	0,3 - 1,5 bar	F 013601 200
FF- 6-G ^{3/8} -K	1 - 6 bar	F 013602 200
FF- 10-G ^{3/8} -K	1 - 10 bar	F 013606 200
FF- 16-G ^{3/8} -K	2,5 - 16 bar	F 013603 200
FF- 40-G ^{3/8} -K	6 - 40 bar	F 013604 200

Technical data

Process connection

Fitting	Blue: plastic, ABS, maximum 16 bar Black: plastic, PA (modified), maximum 40 bar
Connection thread	G3/8", optional: G1/2", G1/4"
Diaphragm material	Perbunan, optional: Viton, Teflon
Working pressure max.	40 bar
Proof pressure	60 bar

Standard micro switch (with a adjustable hysteresis)

Operating voltage (AC) max.	480 V
Operating current (bei 250V AC)	15 A
Operating current (bei 480V AC)	6 A
Operating voltage (DC) max.	125 V
Operating current (bei 24V DC)	5 A
Operating current (bei 125V DC)	0,4 A

Micro switch with gold-plated contacts

Operating voltage (AC) max.	125 V
Operating current (bei 125V AC)	1 A
Operating voltage (DC) max.	24 V
Operating current (bei 24V DC)	1 A

Micro switch with manual reset

Operating voltage (AC) max.	480 V
Operating current (bei 250V AC)	10 A
Operating current (bei 480V AC)	3 A
Operating voltage (DC) max.	125 V
Operating current (bei 125V DC)	1 A (0,5 A at fixed hysteresis)
Operating current (bei 125V DC)	0,4 A

Enclosure

Material under part	Alu die casting Material 230, resistant to seawater
Transparent cover	Polycarbonate (Makrolon) with injection-moulded seal
Dimensions: Height / Width/ Depht	131,5mm / 96,2mm / 87mm
Cable entry (standard)	Rubber grommet
IP 65 version	Cable gland M20*1,5
Cable arrestor	Cable tie (Polyamide)

General data

Weight	ca. 0,8kg
Ambient temperature limits	-30...+70°C
Switching frequency	1800 / h
Vibration	2...15Hz
Amplitude	+/-1,6mm, 25...100Hz, 4g

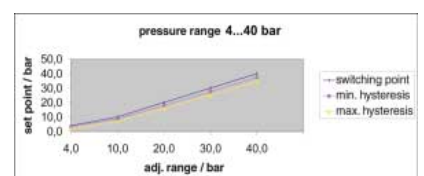
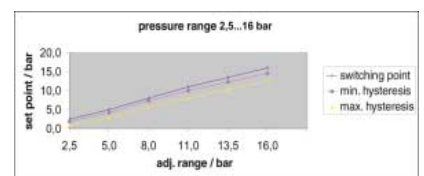
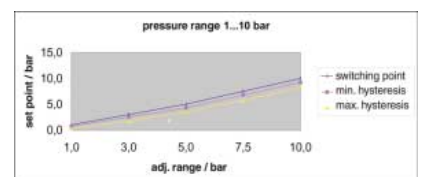
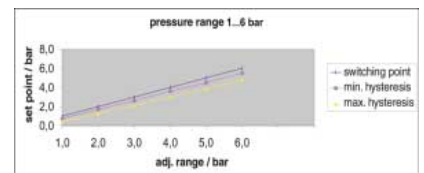
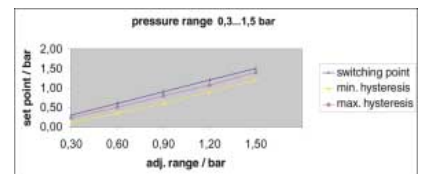

Pressure switch FF 1...300 EEx i

Diaphragm and Piston switches



Characteristics

The FF pressure switch can be used for both pressure monitoring and control tasks. If the pressure at the compressed air supply reaches the set point, the micro switch closes the normally open contact 1-4, and the normally closed contact is opened. Contact 1-2 is not closed until the pressure has dropped by the set hysteresis value. Set point and hysteresis may be adjusted independently of one another, the scales only serving for orientation. A precise adjustment is only possible with suitable test equipment (e.g. a manometer).

- 7 pressure ranges up to 300 bar
- adjustment of set point and hysteresis
- high set point repeatability
- 1 SPDT contact; gold plated contacts optional
- robust housing

Ordering details

Type	Pressure range	Order No.
FF- 1-G ³ / ₈ -EEx i	0,3 - 1,5 bar	F 013601 002
FF- 6-G ³ / ₈ -EEx i	1 - 6 bar	F 013602 002
FF- 10-G ³ / ₈ -EEx i	1 - 10 bar	F 013606 002
FF- 16-G ³ / ₈ -EEx i	2,5 - 16 bar	F 013603 002
FF- 40-G ³ / ₈ -EEx i	6 - 40 bar	F 013604 002
FF- 160-G ³ / ₈ -EEx i	20 - 160 bar	F 013607 002
FF- 300-G ³ / ₈ -EEx i	30 - 300 bar	F 013605 002

Technical data

Process connection

Fitting	Alu die castings, material 230, resistant to seawater G3/8", optional: G1/2"
Connection thread	Perbunan, optional: Viton, Teflon
Diaphragm material	diaphragm: 40 bar, piston: 300 bar
Working pressure max.	diaphragm: 60 bar, piston: 450 bar
Proof pressure	

Standard micro switch (with a adjustable hysteresis)

Operating voltage (AC) max.	480 V
Operating current (bei 250V AC)	15 A
Operating current (bei 480V AC)	6 A
Operating voltage (DC) max.	125 V
Operating current (bei 24V DC)	5 A
Operating current (bei 125V DC)	0,4 A

Micro switch with gold-plated contacts

Operating voltage (DC) max.	24 V
Operating current (bei 24V DC)	1 A

Micro switch with manual reset

Operating voltage (AC) max	480 V
Operating current (bei 250V AC)	10 A
Operating current (bei 480V AC)	3 A
Operating voltage (DC) max.	125 V
Operating current (bei 125V DC)	1 A (0,5 A at fixed hysteresis)
Operating current (bei 125V DC)	0,4 A

Enclosure

Material under part	Alu die casting Material 230, resistant to seawater
Transparent cover	Polycarbonate (Makrolon) with injection-moulded seal
Dimensions: Height / Width/ Dept	131,5mm / 96,2mm / 87mm
IP 65 version	Cable gland M20*1,5
Cable arrestor	Cable tie (Polyamide)

General data

Weight	ca. 0,8kg
Ambient temperature limits	-30...+70°C
Switching frequency	1800 / h
Vibration	2...15Hz
Amplitude	+/-1,6mm, 25...100Hz, 4g

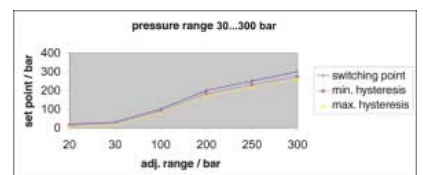
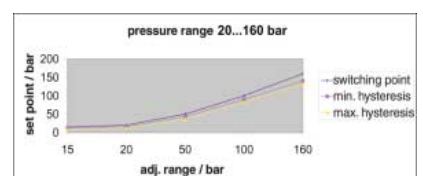
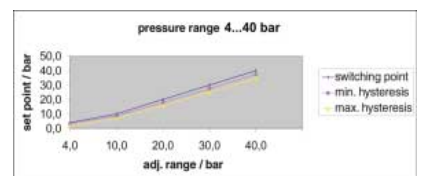
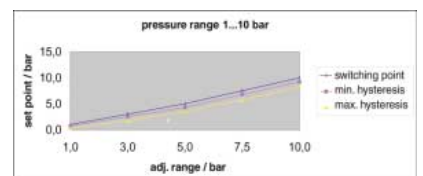
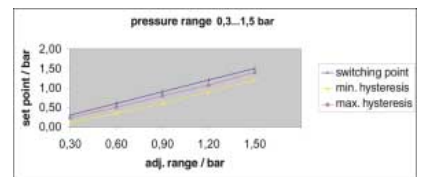

Pressure switch FF

Diaphragm and piston switches

Hysteresis adjustment

Type	Set point range	Standard version adj. hysteresis	-M Micro switch fixed hysteresis	-H Micro switch fixed hysteresis	Proof pressure bar	Version
FF 1	0,3 - 1,5 bar	0,05 - 0,25 bar	0,2 - 0,4 bar	0,1 - 0,3 bar	9	Diaphragm
FF 6	1 - 6 bar	0,2 - 1 bar	0,2 - 0,4 bar	0,1 - 0,3 bar	9	Diaphragm
FF 10	1 - 10 bar	0,2 - 1,7 bar	0,1 - 0,8 bar	0,1 - 0,5 bar	25	Diaphragm
FF 16	2,5 - 16 bar	0,5 - 2,2 bar	0,5 - 1,0 bar	0,4 - 0,6 bar	25	Diaphragm
FF 40	6 - 40 bar	0,6 - 4,2 bar	1,5 - 2,5 bar	1,0 - 1,4 bar	60	Diaphragm
FF 160	20 - 160 bar	3 - 28 bar	6,0 - 25 bar	4,0 - 15 bar	450	Piston
FF 300	30 - 300 bar	6 - 42 bar	6,0 - 25 bar	4,0 - 15 bar	450	Piston

Notes

- Hysteresis:** The hysteresis data (deadband) refer to minimum hysteresis at low end of range and maximum hysteresis at top end of the range.
- Working pressure:** The maximum working pressure limits for all diaphragm versions are 1...40 bar. The piston versions are rated at 300 bar (higher working pressures on request).
- Proof pressure:** The designed proof pressure limit for all diaphragm versions is at least 60 bar but for production reasons they are only tested up to the indicated proof pressure. Diaphragm versions for a proof pressure of up to 100 bar are available on request.

Dimensional drawings

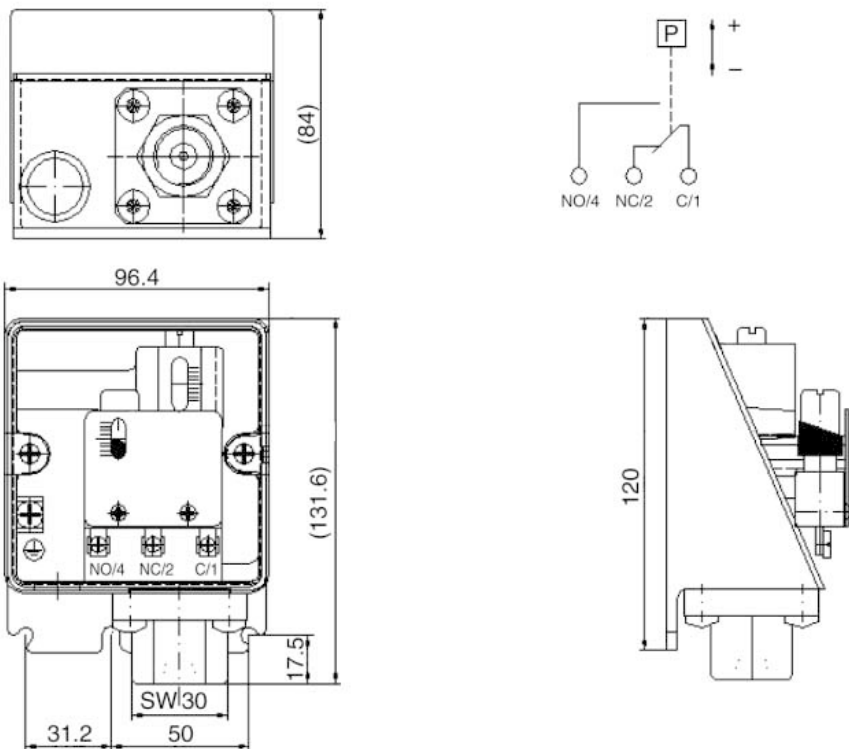

Pressure switch FF

Diaphragm and piston switches

Part No. key to standard options

F 01360

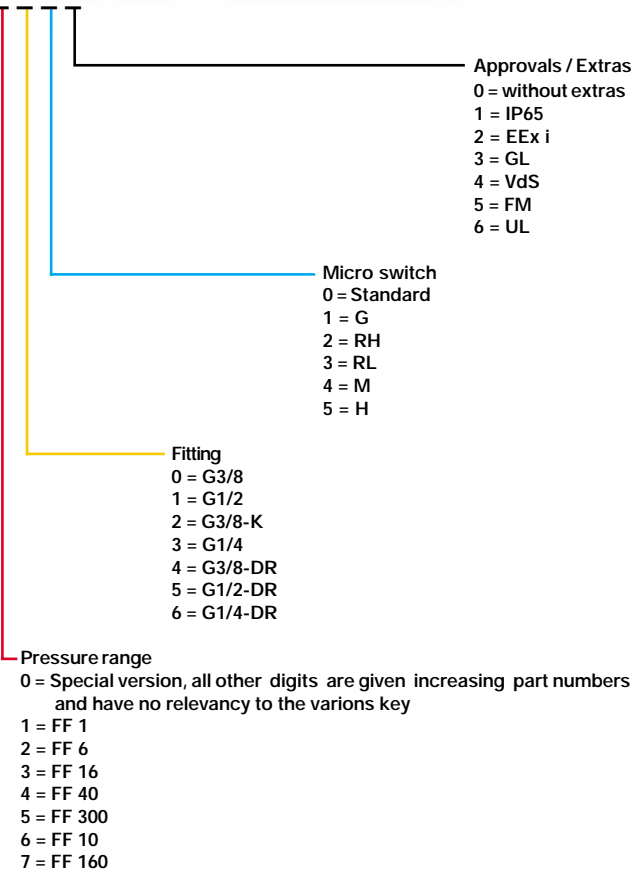

Abbreviations

Standard options:

-CSA / UL	CSA and or UL approval; consult us for availability
-EEx i	Supplied with special cable gland and sticker for confirmation with Cenelec EEx i intrinsically safe circuits
-DR	0,5 mm bore restriction in the fitting to dampen pressure pulses in to the switch
-G 3/8, G 1/2, G 1/4	BSP (G) threaded fitting with cylindrical female thread, flat face for sealing on the outside (top) face of the hexagon
-G	Micro switch option with gold plating on fine Silver contacts
-GL	Approval according to German Lloyds
-FM	Approved by Factory Mutual (US); consult us on availability
-H	Micro Switch with fixed small hysteresis (dead band) and fine Silver contacts
-GH	As above but with gold plated contacts
-IP 65	Gable gland, in PA 6.6 (IP 65) instead of rubber grommet (IP 54)
-K	Povodur ABS Fitting, approved also for potable water, max press. 16 bar
-M	Micro Switch with fixed hysteresis (dead band) and fine Silver contacts capable of handling larger DC loads
-RH	Micro Switch with manual reset for increasing set points
-SP1	Factory setting for one (pressure) set point
-SP2	Factory setting for (pressure) set point and hysteresis
-V	Viton diaphragm instead of Buna
-VdS	Approval for sprinkler applications by German VdS certifying organisation
-EPDM	EPDM Diaphragm, instead of Buna
-T	Teflon Diaphragm, instead of Buna

More options are available, please consult your supplier.

ABB



2- and 3-pole Pressure switches 1...12 bar

FF51 / FF53



Technical data

Type	FF51	FF53
Rated insulation voltage	500 V	500 V
Conventional thermal current I _{th}	16 A	16 A
Switching power AC 3	250 V, 1~: 2,5 kW	400 V, 50/60 Hz: 4 kW
Contacts	2 NC	3 NC
Protection	IP 44	IP 44
Max. ambient media temperature	+ 55°C	+ 55°C
No. of cable connections	2, built in (Ø 11 mm)	2, built in (Ø 11 mm)
Weight approx.	0,4 kg	0,4 kg

Dimensional drawings

FF 51/53

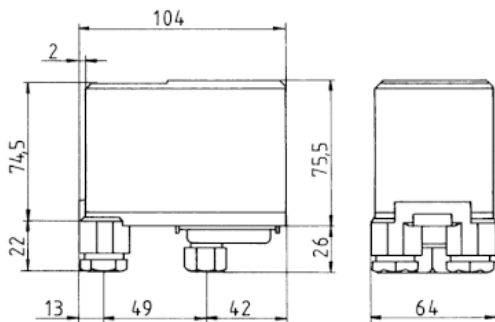

FF 51/53

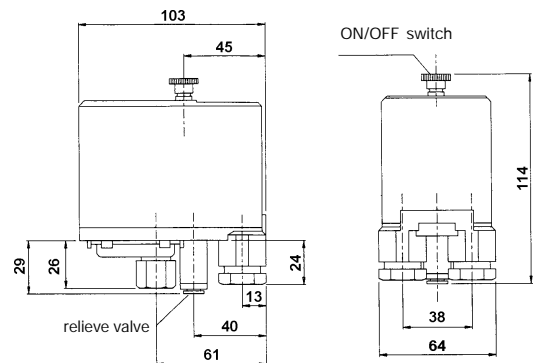

Adj. switching ranges

FF 51/53

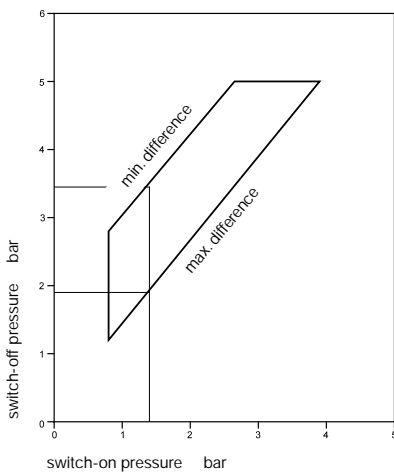

FF 51/53

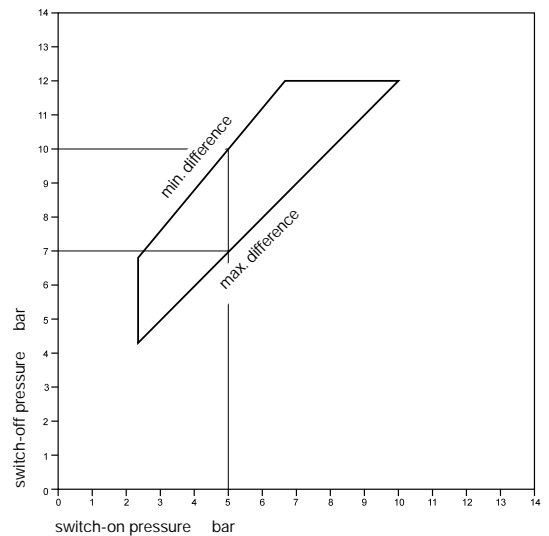

2- and 3-pole Pressure switches 1...12 bar

FF51 / FF53



FF 51...



FF 51...without cover

Pressure switch with Perbunan membrane and 2 NC contacts FF 51

For usage with

- Compressors
- Pressure boilers
- Pumps
- Direct switching of AC motors

FF51-A...

adds the following features to FF51:

- ON/OFF switch
- Pressure relieve valve

Ordering details

Pressure range bar	Adjustable difference bar	Factory adjustment bar	Pressure connection	Type	Order No.
1 ... 5	0,5 ... 2,5	1,4/2,8	G 1/4" inside	FF 51-5	F013100078
3 ... 12	1,8 ... 4	5/7	G 1/4" inside	FF 51-12	F013100077
3 ... 12	1,8 ... 4	5/7	G 1/4" inside	FF 51-A 12	F013100076



FF-53...



FF-53-A...

Pressure switch with Perbunan membrane and 3 NC contacts FF 53

For usage with

- Compressors
- Pressure boilers
- Pumps
- Direct switching of AC motors

FF53-A...

adds the following features to FF53:

- ON/OFF switch
- Pressure relieve valve

Ordering details

Pressure range bar	Adjustable difference bar	Factory adjustment bar	Pressure connection	Type	Order No.
1 ... 5	0,5 ... 2,5	1,4/2,8	G 1/4" innen	FF 53-5	F013100052
1 ... 5	0,5 ... 2,5	1,4/2,8	G 1/2" innen	FF 53-5-I	F013100094
3 ... 12	1,8 ... 4	5/7	G 1/4" innen	FF 53-12	F013100054
3 ... 12	1,8 ... 4	5/7	G 1/2" innen	FF 53-12-I	F013100093
3 ... 12	1,5 ... 4	5/7	G 1/4" innen	FF 53-A 12	F013100073
3 ... 12	1,5 ... 4	5/7	G 1/2" innen	FF 53-A 12-I	F013100095

on request:

other pressure connections, higher IP ratings, gold-plated contacts, stainless steel.

Electronic pump monitor with built-in dry running protection

FP 2



Applications

For usage with (up to 10 bar):

- Pressure-increasing systems
- Small-scale waterworks
- Irrigation plants.

Description

The new electronic pump monitor FP 2 combines pressure switch and flow-through watcher (with dry-running protection) within one appliance. FP 2 perfectly controls and protects AC pumps. Its usage is limited to pumps with a maximum pressure of 10 bar; for usage with higher pressures, an external pressure limiter needs to be installed. A green LED shows operational readiness, a red LED is used to display an error message. The pump starts automatically after it is connected to mains, and the monitor watchdog FP 2 now takes control. If there is pressure in the pipework, but no flow-through, FP 2 shuts down the pump after a short time delay.

If the operating pressure decreases to a point lower than the pre-adjusted switching pressure, FP 2 re-starts the pump. If, however, after re-starting no pressure is built up, FP 2 detects dry-running after a short time delay and switches off the pump again.

The error is displayed via the red LED. The pump can be re-started by pressing the reset button or shortly disconnecting terminals.

Ordering details

Switching pressure	adjustable from...to bar	Max. pressure bar	Connection	Type	Order No.
	1 ... 2	10	G 1"	FP 2	F013100119
	1 ... 2	10	G 1"	FP 2 wired	F013100114

Electronic pump monitor with built-in dry running protection

FP 2

Connection diagram

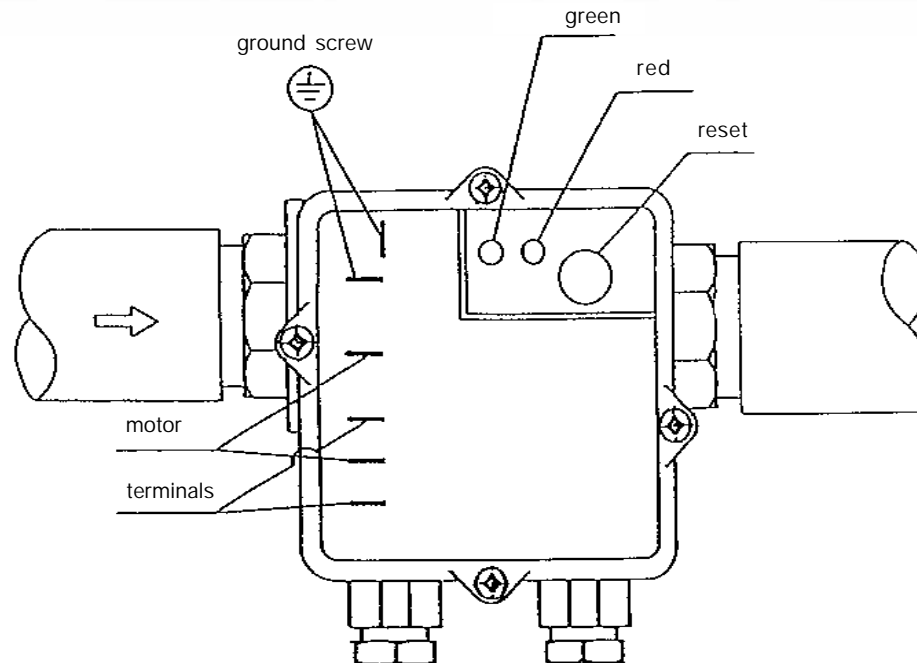

Technical data

Rated operating current I_e	max. 10 A
Rated voltage	230 V AC
Protection to DIN 40 050/IEC 529	IP 54
max. ambient media temperature	(water) + 55°C
Flow-through	max. 80 l/Min.
Contacts	2 S
Dimensions in mm	119 × 148 × 97
Weight (unwired)	ca. 0,38 kg
Weight (wired)	ca. 0,58 kg

