



PROFESSIONAL DIGITAL TWO-WAY RADIO

MOTOTRBO™ DM4600/DM4601 COLOUR DISPLAY MOBILE USER GUIDE

- EN
- DE
- FR
- IT
- ES
- TU
- PL
- RU
- AR



Contents

This User Guide contains all the information you need to use the MOTOTRBO Series Mobiles.

Important Safety Information	viii
Product Safety and RF Exposure Compliance ..	viii
Software Version	viii
Computer Software Copyrights	ix
Getting Started	1
How to Use This User Guide	1
What Your Dealer/System Administrator Can Tell You	1
Powering Up the Radio	2
Adjusting the Volume	2
Identifying Radio Controls	3
Radio Controls	3
Programmable Buttons	4
Assignable Radio Functions	4
Assignable Settings or Utility Functions	6
Accessing the Programmed Functions	6
Push-To-Talk (PTT) Button	7
Switching Between Conventional Analog and Digital Mode	7
Using the Volume/Channel Knob	8

IP Site Connect	8
Capacity Plus	9
Linked Capacity Plus	9
Identifying Status Indicators	10
Display Icons	11
Call Icons	12
Advanced Menu Icons	13
Mini Notice Icons	13
Sent Item Icons	14
Bluetooth Device Icons	14
LED Indicators	15
Indicator Tones	16
Audio Tones	16
Receiving and Making Calls	17
Selecting a Zone	17
Selecting a Channel	18
Receiving and Responding to a Radio Call	18
Receiving and Responding to a Group Call	19
Receiving and Responding to a Private Call	19
Receiving an All Call	20
Receiving and Responding to a Selective Call ..	20
Making a Radio Call	21
Making a Group Call	22
Making a Private Call	22
Making an All Call	23

Making a Selective Call	24	Making a Private Call from Contacts	34
Stopping a Radio Call	24	Assigning an Entry to a Programmable	
Talkaround	25	Number Key	35
Permanent Monitor	25	Removing the Association between Entry and	
Advanced Features	26	Programmable Number Key	36
Radio Check	26	Setting Default Contact	36
Sending a Radio Check	26	Call Indicator Settings	37
Remote Monitor	27	Activating or Deactivating Call Ringers	
Initiating Remote Monitor	27	for Call Alerts	37
Stopping Remote Monitor	28	Activating or Deactivating Call Ringers	
Scan Lists	29	for Private Calls	37
Viewing an Entry in the Scan List	29	Activating or Deactivating Call Ringers	
Editing the Scan List	29	for Selective Call	37
Adding a New Entry to the Scan List	29	Activating or Deactivating Call Ringers	
Deleting an Entry from the Scan List	30	for Text Message	38
Setting and Editing Priority for		Activating or Deactivating Call Ringers	
an Entry in the Scan List	30	for Telemetry Status with Text	38
Scan	31	Assigning Ring Styles	39
Starting and Stopping Scan	31	Escalating Alarm Tone Volume	39
Responding to a Transmission During a Scan ..	32	Call Log Features	40
Deleting a Nuisance Channel	32	Viewing Recent Calls	40
Restoring a Nuisance Channel	32	Deleting a Call from a Call List	40
Vote Scan	33	Call Alert Operation	41
Contacts Settings	33	Receiving and Responding to a Call Alert	41
Making a Group Call from Contacts	34	Making a Call Alert from the Contacts List	42

Making a Call Alert with the One Touch Access Button	42	Receiving a Text Message	53
Emergency Operation	43	Reading a Text Message	53
Receiving an Emergency Alarm	43	Managing Received Text Messages	54
Responding to an Emergency Alarm	44	Viewing a Text Message from the Inbox	54
Sending an Emergency Alarm	44	Viewing a Telemetry Status Text Message from the Inbox	54
Sending an Emergency Alarm with Call	45	Replying to a Text Message with Quick Text ..	55
Sending an Emergency Alarm with Voice to Follow	46	Deleting a Text Message from the Inbox	56
Reinitiating an Emergency Mode	47	Deleting All Text Messages from the Inbox ..	56
Exiting Emergency Mode	48	Analog Message Encode	57
Text Messaging Features	48	Sending MDC Message Encode to Dispatcher ..	57
Sending a Quick Text Message	48	Sending 5-Tone Message Encode to Contact ..	57
Sending a Quick Text Message with the One Touch Access Button	49	Analog Status Update	58
Managing Text Messages in the Drafts Folder ..	49	Sending Status Update to Predefined Contact ..	58
Viewing a Saved Text Message	49	Viewing 5-Tone Status Details	58
Deleting a Saved Text Message from Drafts ..	50	Privacy	59
Managing Fail-to-Send Text Messages	50	Multi-Site Controls	60
Resending a Text Message	50	Starting an Automatic Site Search	60
Forwarding a Text Message	50	Stopping an Automatic Site Search	60
Managing Sent Text Messages	51	Starting a Manual Site Search	61
Viewing a Sent Text Message	51	Security	62
Sending a Sent Text Message	51	Radio Disable	62
Deleting All Sent Text Messages from Sent Items	53	Radio Enable	63
		Lone Worker	64
		Bluetooth	64
		Turning Bluetooth On or Off	65

- Finding and Connecting to a Bluetooth Device . . . 65
- Disconnecting from a Bluetooth Device 66
- Switching Audio Route 66
- Viewing Device Details 66
- Notification List 67
 - Accessing the Notification List 67
- Utilities 67
 - Turning the Radio Tones/Alerts On or Off 67
 - Setting the Tone Alert Volume Offset Level 68
 - Turning the Talk Permit Tone On or Off 68
 - Setting the Power Level 68
 - Changing the Display Mode 69
 - Adjusting the Display Brightness 69
 - Turning Horns/Lights On or Off 70
 - Turning the Public Address System On or Off . . . 70
 - Turning the External Public Address System
On or Off 70
 - Setting the Squelch Level 70
 - Turning the Introduction Screen On or Off 71
 - Turning the LED Indicators On or Off 71
 - Setting Dual Knob Operation Preference 72
 - Language 72
 - Turning the Voice Operating Transmission (VOX)
Feature On or Off 72
 - Turning the Option Board Feature(s) On or Off . . 73
 - Identifying Cable Type 73

- Voice Announcement 73
- Call Forwarding 74
- Menu Timer 74
- Analog Mic AGC 74
- Digital Mic AGC 75
- Intelligent Audio 75
- GPS 76
 - Accessing General Radio Information 76
 - Checking the Radio Alias and ID 76
 - Checking the Firmware Version and Codeplug
Version 77
 - Checking the GPS Information 77
- Keypad Microphone Features 78**
 - Using the Keypad 79
 - Turning Keypad Tones On or Off 80
- Additional Advanced Features 80
 - Selecting a Zone by Alias Search 80
 - Initiating a Radio Check by Manual Dial 81
 - Initiating Remote Monitor by Manual Dial 81
 - Making a Private Call by Manual Dial 82
 - Making a Group, Private or All Call with the
Programmable Number Key 82
 - Making a Group, Private, Phone or All Call
by Alias Search 83

Viewing an Entry in the Scan List by Alias Search	84	Turning the Password Lock On or Off	94
Editing the Scan List by Alias Search	84	Changing the Password	94
Adding a New Entry to the Scan List	84	Front Panel Programming (FPP)	95
Deleting an Entry from the Scan List	85	Entering FPP Mode	95
Setting and Editing Priority for an Entry in the Scan List	86	Editing FPP Mode Parameters	95
Storing an Alias or ID from a Call List	86	Limited Warranty	96
Making a Call Alert by Manual Dial	87		
Text Messaging	87		
Writing and Sending a Text Message	87		
Replying to Text Messages from the Inbox	88		
Editing a Quick Reply Message	89		
Accessing the Drafts Folder	89		
Editing and Sending a Saved Text Message	90		
Managing Fail-to-Send Text Messages	90		
Forwarding a Text Message by Manual Dial	90		
Editing a Text Message	91		
Dual Tone Multi Frequency (DTMF)	91		
Security	92		
Radio Disable via Manual Dial	92		
Radio Enable via Manual Dial	92		
Password Lock Features	93		
Accessing the Radio from Password	93		
Unlocking the Radio from Locked State	94		

Important Safety Information

Product Safety and RF Exposure Compliance



Caution

Before using this product, read the operating instructions for safe usage contained in the Product Safety and RF Exposure booklet enclosed with your radio.

ATTENTION!

This radio is restricted to occupational use only to satisfy FCC/ICNIRP RF energy exposure requirements. Before using this product, read the RF energy awareness information and operating instructions in the Product Safety and RF Exposure booklet enclosed with your radio (Motorola Publication part number 6866537D37) to ensure compliance with RF energy exposure limits.

For a list of Motorola-approved antennas and other accessories, visit the following website:

<http://www.motorolasolutions.com>

Software Version

All the features described in the following sections are supported by the radio's software version **R02.04.00**.

See ***Checking the Firmware Version and Codeplug Version*** on page 77 to determine your radio's software version.

Please check with your dealer or system administrator for more details of all the features supported.

Computer Software Copyrights

The Motorola products described in this manual may include copyrighted Motorola computer programs stored in semiconductor memories or other media. Laws in the United States and other countries preserve for Motorola certain exclusive rights for copyrighted computer programs including, but not limited to, the exclusive right to copy or reproduce in any form the copyrighted computer program. Accordingly, any copyrighted Motorola computer programs contained in the Motorola products described in this manual may not be copied, reproduced, modified, reverse-engineered, or distributed in any manner without the express written permission of Motorola. Furthermore, the purchase of Motorola products shall not be deemed to grant either directly or by implication, estoppel, or otherwise, any license under the copyrights, patents or patent applications of Motorola, except for the normal non-exclusive license to use that arises by operation of law in the sale of a product.

The AMBE+2™ voice coding Technology embodied in this product is protected by intellectual property rights including patent rights, copyrights and trade secrets of Digital Voice Systems, Inc.

This voice coding Technology is licensed solely for use within this Communications Equipment. The user of this Technology is explicitly prohibited from attempting to decompile, reverse engineer, or disassemble the Object Code, or in any other way convert the Object Code into a human-readable form.

U.S. Pat. Nos. #5,870,405, #5,826,222, #5,754,974, #5,701,390, #5,715,365, #5,649,050, #5,630,011, #5,581,656, #5,517,511, #5,491,772, #5,247,579, #5,226,084 and #5,195,166.

Notes

Getting Started

Take a moment to review the following:

How to Use This User Guide	page 1
What Your Dealer/System Administrator Can Tell You	page 1
Powering Up the Radio	page 2
Adjusting the Volume	page 2

■ How to Use This User Guide

This User Guide covers the basic operation of the MOTOTRBO Mobiles.

However, your dealer or system administrator may have customized your radio for your specific needs. Check with your dealer or system administrator for more information.

Throughout this publication, the icons below are used to indicate features supported in either the conventional Analog mode or conventional Digital mode:



Indicates a conventional **Analog Mode-Only** feature.



Indicates a conventional **Digital Mode-Only** feature.

For features that are available in **both** Analog and Digital modes, **no** icon is shown.

For features that are available in a conventional multi-site mode, see **IP Site Connect** on page 8 for more information.

Selected features are available in the single-site trunking mode, Capacity Plus. See **Capacity Plus** on page 9 for more information.

Selected features are **also** available in the multi-site trunking mode, Linked Capacity Plus. See **Linked Capacity Plus** on page 9 for more information.

■ What Your Dealer/System Administrator Can Tell You

You can consult your dealer or system administrator about the following:

- Is your radio programmed with any preset conventional channels?
- Which buttons have been programmed to access other features?
- What optional accessories may suit your needs?
- What are the best radio usage practices for effective communication?
- What maintenance procedures will help promote longer radio life?

■ Powering Up the Radio

Press the **On/Off Button** briefly. You see MOTOTRBO (TM) on the radio's display momentarily, followed by a welcome message or welcome image.

The green LED lights up and the Home screen lights up.

A brief tone sounds, indicating that the power up test is successful.

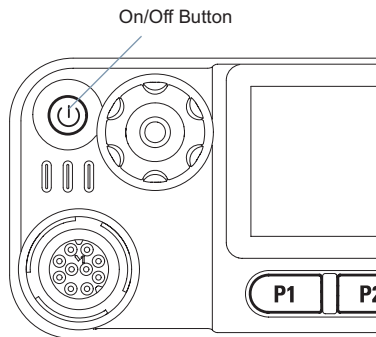

NOTE: There is no power up tone if the radio tones/alerts function is disabled (see **Turning the Radio Tones/ Alerts On or Off** on page 67).

If your radio does not power up, contact your dealer.

*To turn off the radio, press and hold the On/Off Button until you see **Powering Down** on the radio's display.*

NOTE: Your radio may take up to 7 seconds to completely turn off.

■ Adjusting the Volume

To increase the volume, turn the **Volume/Channel Knob** clockwise.

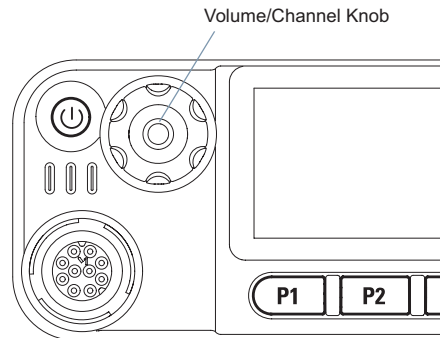

To decrease the volume, turn this knob counterclockwise.

NOTE: Your radio can be programmed to have a minimum volume offset where the volume level cannot be turned past the programmed minimum volume. Check with your dealer or system administrator for more information.

Identifying Radio Controls

Take a moment to review the following:

- Radio Controls. page 3
- Programmable Buttons page 4
- Accessing the Programmed Functions page 6
- Push-To-Talk (PTT) Button page 7
- Using the Volume/Channel Knob. page 8
- Switching Between Conventional Analog and Digital Mode. page 7
- IP Site Connect page 8
- Capacity Plus. page 9
- Linked Capacity Plus. page 9

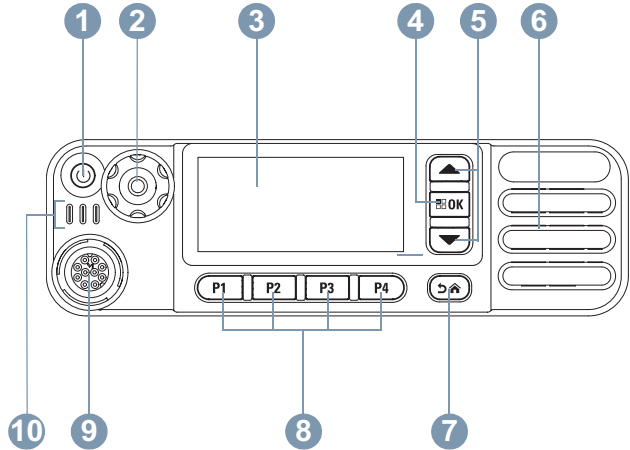

■ Radio Controls

- 1 On/Off Button
- 2 Volume/Channel Knob
- 3 Display
- 4 OK/Menu Button
- 5 Scroll Up/Down
- 6 Speaker
- 7 Return/Home Button
- 8 Front Programmable Buttons
- 9 Accessory Connector
- 10 LED Indicators

■ Programmable Buttons

Your dealer can program the programmable buttons as shortcuts to **radio functions** or up to a maximum of six (6) **preset channels/groups** depending on the duration of a button press:

- Short press – Pressing and releasing rapidly.
- Long press – Pressing and holding for the programmed duration.
- Hold down – Keeping the button pressed.

NOTE: The programmed duration of a button press is applicable for all assignable radio/utility functions or settings. See **Emergency Operation** on page 43 for more information on the programmed duration of the **Emergency** button.

📄 Assignable Radio Functions

Bluetooth™ Audio Switch – Toggles audio routing between internal radio speaker and external Bluetooth-enabled accessory.

Contacts – Provides direct access to the contacts list.

Call Alert – Provides direct access to the contacts list for you to select a contact to whom a Call Alert can be sent.

Call Forwarding – Toggles Call Forwarding on or off.

Call Log – Selects the call log list.

Voice Announcement for Channel – Plays zone and channel announcement voice messages for the current channel. This function is unavailable when Voice Announcement is disabled.

Emergency – Depending on the programming, initiates or cancels an Emergency alarm or call.

Ext PA On/Off – Toggles the audio routing between the connected public address (PA) loudspeaker amplifier and the radio's internal public address (PA) system.

Intelligent Audio On/Off – Toggles Intelligent Audio on or off.

Manual Dial  – Initiates a call by keying in any subscriber ID.

Manual Site Roam†**  – Starts the manual site search.

Mic AGC On/Off – Toggles the internal microphone automatic gain control (AGC) on or off. Not applicable during a Bluetooth session.

Monitor – Monitors a selected channel for activity.

Nuisance Channel Delete†** – Temporarily removes an unwanted channel, except for the Selected Channel, from the scan list. The Selected Channel refers to the user's selected zone/channel combination from which scan is initiated.

* Not applicable in Capacity Plus

† Not applicable in Linked Capacity Plus

One Touch Access  – Directly initiates a predefined Private or Group Call, a Call Alert or a Quick Text message.

Option Board Feature – Toggles option board feature(s) on or off for option board-enabled channels.

PA On/Off – Toggles the radio's internal public address (PA) system on or off.

Permanent Monitor** – Monitors a selected channel for all radio traffic until function is disabled.

Privacy  – Toggles privacy on or off.

Radio Alias and ID – Provides radio alias and ID.

Radio Check  – Determines if a radio is active in a system.

Radio Enable  – Allows a target radio to be remotely enabled.

Radio Disable  – Allows a target radio to be remotely disabled.

Remote Monitor  – Turns on the microphone of a target radio without it giving any indicators.

Repeater/Talkaround** – Toggles between using a repeater and communicating directly with another radio.

Scan** – Toggles scan on or off.

Site Lock On/Off*  – Toggles the automatic site roam on or off.

Status – Selects the status list menu.

Telemetry Control  – Controls the Output Pin on a local or remote radio.

Text Message  – Selects the text message menu.

Transmit Interrupt Remote Dekey  – Stops the transmission of a remote monitored radio without giving any indicators, or an ongoing interruptible call to free the channel.

Voice Announcement On/Off – Toggles Voice Announcement on or off.

Voice Operating Transmission (VOX) – Toggles VOX on or off.

Zone Toggle – Allows radio to switch between zones.

* Not applicable in Capacity Plus
‡ Not applicable in Linked Capacity Plus

Assignable Settings or Utility Functions

All Tones/Alerts – Toggles all tones and alerts on or off.

Backlight – Adjusts the brightness level.

Channel Up/Down – Depending on the programming, changes channel to previous or next channel.

Display Mode – Toggles the day/night display mode on or off.

Power Level – Toggles transmit power level between high and low.

Squelch  – Toggles squelch level between tight and normal.







■ Accessing the Programmed Functions

You can access various radio functions through one of the following ways:

- A short or long press of the relevant programmable buttons.

OR

- Use the Menu Navigation Buttons as follows:

- 1 To access the menu, press the  button. Press the appropriate **Scroll Up/Down** button ( or ) to access the menu functions.
- 2 To select a function or enter a sub-menu, press the  button.
- 3 To go back one menu level, or to return to the previous screen, press the  button. Long press the  button to return to the Home screen.

*The Menu Navigation Buttons are also available on a keypad microphone (see **Using the Keypad** on page 79).*

NOTE: Your radio automatically exits the menu after a period of inactivity and returns to your Home screen.

■ Push-To-Talk (PTT) Button

The **PTT** button on the side of the microphone serves two basic purposes:

- While a call is in progress, the **PTT** button allows the radio to transmit to other radios in the call.

Press and hold down **PTT** button to talk. Release the **PTT** button to listen.

The microphone is activated when the **PTT** button is pressed.

- While a call is not in progress, the **PTT** button is used to make a new call (see **Making a Radio Call** on page 21).

If the Talk Permit Tone (see **Turning the Talk Permit Tone On or Off** on page 68) or the **PTT** Sidetone  is enabled, wait until the short alert tone ends before talking.

 During a call, if the Channel Free Indication feature is enabled on your radio (programmed by your dealer), you hear a short alert tone the moment the target radio (the radio that is receiving your call) releases the **PTT** button, indicating the channel is free for you to respond.

 You will also hear a continuous talk prohibit tone, if your call is interrupted, indicating that you should release the

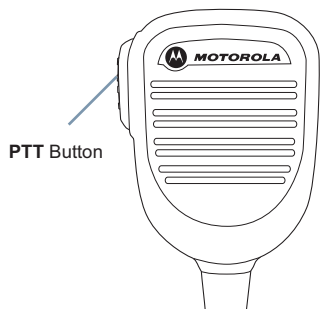

PTT button, for example when the radio receives an Emergency Call.

■ Switching Between Conventional Analog and Digital Mode

Each channel in your radio can be configured as a conventional analog or conventional digital channel.

To switch between an analog or a digital channel, use the



- **Scroll Up/Down** buttons, or
- **Volume/Channel Knob**, or
- programmed **Channel Up** or **Channel Down** buttons

When switching from digital to analog mode, certain features are unavailable. Icons for the digital features (such as Messages) reflect this change by appearing 'greyed out'. Disabled features are hidden in the menu.

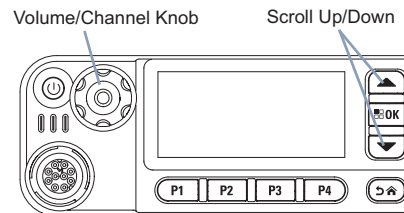
Your radio also has features available in both analog and digital mode. However, the minor differences in the way each feature works does **NOT** affect the performance of your radio.



NOTE: Your radio also switches between digital and analog modes during a dual mode scan (see **Scan** on page 31).

To use the **Scroll Up/Down** buttons, while in the Home Screen of the required Zone, press  or  to select the required channel.

To use the programmed **Channel Up** or **Channel Down** buttons, while in the Home Screen of the required Zone, press **Channel Up** or **Channel Down** to select the required channel.



■ Using the Volume/Channel Knob

The **Volume/Channel Knob** can be programmed as dual purpose for both volume and channel or as a volume-only control.

To adjust volume, see **Adjusting the Volume** on page 2.

To change channels, push and hold the knob until channel selection screen is displayed, then turn the knob to the required channel.

To exit channel selection state, do any of the following.

- Push the **Volume/Channel Knob** again
- Press 
- Press 
- Wait for the menu timer to expire

■ IP Site Connect

This feature allows your radio to extend conventional communication beyond the reach of a single site, by connecting to different available sites which are connected via an Internet Protocol (IP) network.

When the radio moves out of range from one site and into the range of another, it connects to the new site's repeater to send or receive calls/data transmissions. Depending on your settings, this is done automatically or manually.

If the radio is set to do this automatically, it scans through all available sites when the signal from the current site is weak or when the radio is unable to detect any signal from the current site. It then locks on to the repeater with the strongest Received Signal Strength Indicator (RSSI) value.

In a manual site search, the radio searches for the next site in the roam list that is currently in range (but which may not have the strongest signal) and locks on to it.

NOTE: Each channel can only have either Scan or Roam enabled, not both at the same time.

Channels with this feature enabled can be added to a particular roam list. The radio searches the channel(s) in the roam list during the automatic roam operation to locate the best site.

A roam list supports a maximum of 16 channels (including the Selected Channel).

NOTE: You cannot manually add or delete an entry to the roam list. Check with your dealer or system administrator for more information.

■ Capacity Plus

Capacity Plus is a single-site trunking configuration of the MOTOTRBO radio system, which uses a pool of channels to support hundreds of users and up to 254 Groups. This feature allows your radio to efficiently utilize the available number of programmed channels while in Repeater Mode.

Icons of features not applicable to Capacity Plus are not available in the menu. You hear a negative indicator tone if you try to access a feature not applicable to Capacity Plus via a programmable button press.

Your radio also has features that are available in conventional digital mode, IP Site Connect, Capacity Plus and Linked Capacity Plus. However, the minor differences in the way each feature works does **NOT** affect the performance of your radio.

Check with your dealer or system administrator for more information on this configuration.

■ Linked Capacity Plus

Linked Capacity Plus is a multi-site multi-channel trunking configuration of the MOTOTRBO radio system, combining the best of both Capacity Plus and IP Site Connect configurations.

Linked Capacity Plus allows your radio to extend trunking communication beyond the reach of a single site, by connecting to different available sites which are connected via an Internet Protocol (IP) network. It also provides an increase in capacity by efficiently utilizing the combined available number of programmed channels supported by each of the available sites.

When the radio moves out of range from one site and into the range of another, it connects to the new site's repeater to send or receive calls/data transmissions. Depending on your settings, this is done automatically or manually.

If the radio is set to do this automatically, it scans through all available sites when the signal from the current site is weak or when the radio is unable to detect any signal from the current site. It then locks on to the repeater with the strongest Received Signal Strength Indicator (RSSI) value.

In a manual site search, the radio searches for the next site in the roam list that is currently in range (but which may not have the strongest signal) and locks on to it.

Any channel with Linked Capacity Plus enabled can be added to a particular roam list. The radio searches these channels during the automatic roam operation to locate the best site.

NOTE: You cannot manually add or delete an entry to the roam list. Check with your dealer or system administrator for more information.

Similar to Capacity Plus, icons of features not applicable to Linked Capacity Plus are not available in the menu. You hear a negative indicator tone if you try to access a feature not applicable to Linked Capacity Plus via a programmable button press.

Check with your dealer or system administrator for more information on this configuration.

Identifying Status Indicators

Your radio indicates its operational status through the following:

Display Icons	page 11
Call Icons	page 12
Sent Item Icons	page 14
LED Indicators	page 15
Audio Tones	page 16
Indicator Tones	page 16

■ Display Icons

The liquid crystal display (LCD) of your radio shows the radio status, text entries, and menu entries.

The following are icons that appear on the status bar at the top of the radio's display. Icons are displayed on the status bar, arranged left-to-right, in order of appearance/usage and are channel specific.



Received Signal Strength Indicator (RSSI)

The number of bars displayed represents the radio signal strength. Four bars indicate the strongest signal. This icon is only displayed while receiving.



Bluetooth

The Bluetooth feature is enabled but there is no remote Bluetooth device connected.



Bluetooth Connected

The Bluetooth feature is enabled. The icon stays lit when one or more remote Bluetooth devices are connected.



Emergency

Radio is in Emergency mode.



Notification

Notification list is not empty.



Scan*‡

Scan feature is enabled.



Scan – Priority 1*‡

Radio detects activity on channel/group designated as Priority 1).



Scan – Priority 2*‡

Radio detects activity on channel/group designated as Priority 2.



Vote Scan

Vote scan feature is enabled.



Monitor

Selected channel is being monitored.



Talkaround*‡

In the absence of a repeater, radio is currently configured for direct radio to radio communication.



Site Roaming*

The site roaming feature is enabled.



Secure

The Privacy feature is enabled.



Unsecure

The Privacy feature is disabled.



GPS Available

The GPS feature is enabled. The icon stays lit when a position fix is available.

* Not applicable in Capacity Plus

‡ Not applicable in Linked Capacity Plus



GPS Not Available/Out of Range

The GPS feature is enabled but is not receiving data from the satellite.



Option Board

The Option Board is enabled.



Option Board Non-Function

The Option Board is disabled.



Tones Disable

Tones are turned off.



Power Level

Radio is set at Low power.

OR



Radio is set at High power.

* Not applicable in Capacity Plus

‡ Not applicable in Linked Capacity Plus

Call Icons

The following icons appear on the radio's display during a call. These icons also appear in the Contacts list to indicate alias or ID type.



Private Call

Indicates a Private Call in progress.

In the Contacts list, it indicates a subscriber alias (name) or ID (number).



Group Call/All Call

Indicates a Group Call or All Call in progress.

In the Contacts list, it indicates a group alias (name) or ID (number).

■ Advanced Menu Icons

The following icons appear beside menu items on the radio's display that offer a choice between two options or as an indication that there is a sub-menu offering two options.



Checkbox (Empty)

Indicates the option is not selected.



Checkbox (Checked)

Indicates the option is selected.



Solid Black Box

Indicates the option selected for the menu item with a sub-menu.

■ Mini Notice Icons

The following icons appear momentarily on the radio's display after an action to perform task is taken.



Successful Transmission (Positive)

Successful action taken.



Failed Transmission (Negative)

Failed action taken.



Transmission in Progress (Transitional)

Transmitting. This dynamic icon is seen before indication for Successful Transmission or Failed Transmission.

■ Sent Item Icons

The following icons appear in the Sent Items folder.



OR

Sent Successfully

The text message is sent successfully.



OR

Send Failed

The text message cannot be sent.



OR

In-Progress

- The text message to a subscriber alias or ID is pending transmission, followed by waiting for acknowledgement.
- The text message to a group alias or ID is pending transmission.



■ Bluetooth Device Icons

The following icons also appear next to items in the list of Bluetooth-enabled devices available to indicate the device type.



Bluetooth Data Device

Bluetooth-enabled data device, such as a scanner.



Bluetooth Audio Device

Bluetooth-enabled audio device, such as a headset.



Bluetooth PTT Device

Bluetooth-enabled PTT device, such as a PTT-Only Device (POD).

■ LED Indicators

LED indicators show the operational status of your radio.

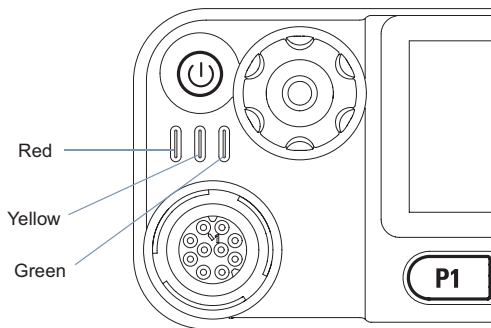

Blinking red – Radio is receiving an emergency transmission or has failed the self-test upon powering up.

Solid green – Radio is powering up, or transmitting.

Blinking green – Radio is receiving a non-privacy-enabled call or data, or detecting activity over the air.

Double blinking green – Radio is receiving a privacy-enabled call or data.

Solid yellow – Radio is monitoring a conventional channel.

Blinking yellow – Radio is scanning for activity or receiving a Call Alert, or all local Linked Capacity Plus channels are busy.

Double blinking yellow – Radio is no longer connected to the repeater while in Capacity Plus or Linked Capacity Plus, all Capacity Plus channels or Linked Capacity Plus channels are currently busy, Auto Roaming is enabled, radio is actively searching for a new site. Also indicates radio has yet to respond to a group call alert, or radio is locked.

NOTE: While in conventional mode, when the green LED blinks, it indicates the radio detects activity over the air. Due to the nature of the digital protocol, this activity may or may not affect the radio's programmed channel.

For Capacity Plus and Linked Capacity Plus, there is no LED indication when the radio is detecting activity over the air.

■ Indicator Tones

High pitched tone □

Low pitched tone ■



Positive Indicator Tone



Negative Indicator Tone

■ Audio Tones

Alert tones provide you with audible indications of the radio's status or the radio's response to data received.

Continuous Tone



A monotone sound. Sounds continuously until termination.

Periodic Tone



Sounds periodically depending on the duration set by the radio. Tone starts, stops, and repeats itself.

Repetitive Tone



A single tone that repeats itself until it is terminated by the user.

Momentary Tone



Sounds only once for a short period of time defined by the radio.

Receiving and Making Calls

Once you understand how your MOTOTRBO Mobile is configured, you are ready to use your radio.

Use this navigation guide to familiarize yourself with the basic Call features:

Selecting a Zone	page 17
Selecting a Radio Channel, Subscriber Alias or ID, or Group Alias or ID	page 18
Receiving and Responding to a Radio Call	page 18
Making a Radio Call	page 21
Stopping a Radio Call	page 24
Talkaround	page 25
Permanent Monitor	page 25

Selecting a Zone

A zone is a group of channels. Your radio supports up to 99 channels and 2 zones, with a maximum of 99 channels per zone.







Use the following procedure to select a zone.

Procedure:

Press the programmed **Zone** button and proceed to Step 3.

OR

Follow the procedure below.

- 1  to access the menu.
- 2  or  to Zone and press  to select.
- 3 The current zone is displayed and indicated by a ✓.
- 4  or  to the required zone and press  to select.
- 5 The display shows <Zone> Selected momentarily and returns to the selected zone screen.

■ Selecting a Channel

Transmissions are sent and received on a channel. Depending on your radio's configuration, each channel may have been programmed differently to support different groups of users or supplied with different features. After selecting the required zone, select the channel you require to transmit or receive on.

Procedure:

Select a channel by using:

- **Scroll Up/Down** buttons, OR
- **Volume/Channel Knob**, OR
- The programmed **Channel Up** or **Channel Down** buttons

See **Selecting a Zone** on page 17 for more information on selecting your required zone.

See **Switching Between Conventional Analog and Digital Mode** on page 7 for information about **Scroll Up/Down** buttons.

See **Using the Volume/Channel Knob** on page 8 for information about using the **Volume/Channel Knob**.

See **Programmable Buttons** on page 4 for information about the **Channel Up** or **Channel Down** buttons.

■ Receiving and Responding to a Radio Call

Once the channel, subscriber alias or ID, or group alias or ID is displayed, you can proceed to receive and respond to calls.

The green LED lights up while the radio is transmitting and blinks when the radio is receiving.

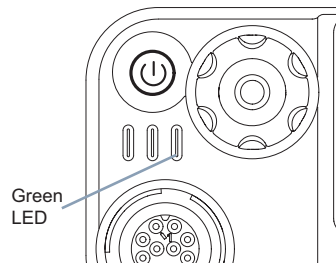

NOTE: The green LED lights up while the radio is transmitting and double blinks when the radio is receiving a privacy-enabled call.

To unscramble a privacy-enabled call, your radio must have the same Privacy Key, or the same Key Value and Key ID (programmed by your dealer) as the transmitting radio (the radio you are receiving the call from).

See **Privacy** on page 59 for more information. 

Receiving and Responding to a Group Call



To receive a call made to a group of users, your radio must be configured as part of that group.

Procedure:

When you receive a Group Call (while on the Home screen):

- 1 The green LED blinks.

- 2 The Group Call icon appears in the top right corner. The first text line shows the caller alias. The second text line displays the group call alias. Your radio unmutes and the incoming call sounds through the radio's speaker.

- 3  If the Channel Free Indication feature is enabled, you hear a short alert tone the moment the transmitting radio releases the **PTT** button, indicating the channel is free for you to respond.
Press the **PTT** button to respond to the call.
OR
 If the Voice Interrupt feature is enabled, press the **PTT** button to stop the current call from the transmitting radio and free the channel for you to talk/respond.

- 4 The green LED lights up.

- 5 Wait for the Talk Permit Tone to finish (if enabled) and speak clearly into the microphone.
OR

 Wait for the **PTT** Sidetone to finish (if enabled) and speak clearly into the microphone.

- 6 Release the **PTT** button to listen.

- 7 If there is no voice activity for a predetermined period of time, the call ends.

See **Making a Group Call** on page 22 for details on making a Group Call.

Receiving and Responding to a Private Call

A Private Call is a call from an individual radio to another individual radio.

Procedure:

When you receive a Private Call:

- 1 The green LED blinks.

- 2 The Private Call icon appears in the top right corner. The first text line shows the caller alias. Your radio unmutes and the incoming call sounds through the radio's speaker.

- 3 If the Channel Free Indication feature is enabled, you hear a short alert tone the moment the transmitting radio releases the **PTT** button, indicating the channel is free for you to respond.
Press the **PTT** button to respond to the call.
OR
If the Voice Interrupt feature is enabled, press the **PTT**

button to stop the current call from the transmitting radio and free the channel for you to talk/respond.

- 4 The green LED lights up.
- 5 Wait for the Talk Permit Tone to finish (if enabled) and speak clearly into the microphone.
- 6 Release the **PTT** button to listen.
- 7 If there is no voice activity for a predetermined period of time, the call ends.
- 8 You hear a short tone. The display shows `Call Ended`.

See **Making a Private Call** on page 22 for details on making a Private Call.

Receiving an All Call

An All Call is a call from an individual radio to every radio on the channel. It is used to make important announcements requiring the user's full attention.

Procedure:

When you receive an All Call:

- 1 A tone sounds and the green LED blinks.
- 2 The Group Call icon appears in the top right corner. The first text line shows the caller alias. The second text line displays `All Call`. Your radio unmutes and the incoming call sounds through the radio's speaker.

- 3 Once the All Call ends, the radio returns to the previous screen before receiving the call. An All Call does not wait for a predetermined period of time before ending.

 If the Channel Free Indication feature is enabled, you hear a short alert tone the moment the transmitting radio releases the **PTT** button, indicating the channel is now available for use.

You cannot respond to an All Call.

See **Making an All Call** on page 23 for details on making an All Call.

NOTE: The radio stops receiving the All Call if you switch to a different channel while receiving the call. During an All Call, you are **not** able to continue with any menu navigation or editing until the call ends.

Receiving and Responding to a Selective Call

A Selective Call is a call from an individual radio to another individual radio. It is a Private Call on an analogue system.

Procedure:

When you receive a Selective Call:

- 1 The green LED blinks.
- 2 The Private Call icon appears in the top right corner. The first text line shows the caller alias or `Selective Call` or



Alert with Call. Your radio unmutes and the incoming call sounds through the radio's speaker.

- 3 If the Channel Free Indication feature is enabled, you hear a short alert tone the moment the transmitting radio releases the **PTT** button, indicating the channel is free for you to respond.
Press the **PTT** button to respond to the call.
- 4 The LED lights up solid green.
- 5 Wait for the Talk Permit Tone to finish (if enabled) and speak clearly into the microphone.
- 6 Release the **PTT** button to listen.
- 7 If there is no voice activity for a predetermined period of time, the call ends.
- 8 You hear a short tone. The display shows **Call Ended**.

NOTE: See ***Making a Selective Call*** on page 24 for details on making a Selective Call.

■ Making a Radio Call

After selecting your channel, you can select a subscriber alias or ID, or group alias or ID by using:

- The Contacts list (see ***Contacts Settings*** on page 33)
- A programmed **One Touch Access** button 
- The programmed number keys – This method is for Group, Private and All Calls only and is used with the keypad microphone (see ***Making a Group, Private or All Call with the Programmable Number Key*** on page 82). 
- Manual Dial (via Contacts) – This method is for Private Calls only and is dialed using a keypad microphone (see ***Making a Private Call by Manual Dial*** on page 82) 

NOTE: Your radio must have the Privacy feature enabled on the channel to send a privacy-enabled transmission. Only target radios with the same Privacy Key as your radio are able to unscramble the transmission.

See ***Privacy*** on page 59 for more information. 



The One Touch Access feature allows you to make a Group or Private Call to a predefined ID easily. This feature can be assigned to a short or long programmable button press. You can **ONLY** have one ID assigned to a **One Touch Access** button. Your

radio can have multiple **One Touch Access** buttons programmed.

Making a Group Call

To make a call to a group of users, your radio must be configured as part of that group.

Procedure:

- 1 Select the channel with the active group alias or ID. See **Selecting a Channel** on page 18.
OR
Press the programmed **One Touch Access** button.
- 2 Press the **PTT** button to make the call. The green LED lights up. The Group Call icon appears in the top right corner. The first text line shows the group call alias.
- 3 Wait for the Talk Permit Tone to finish (if enabled) and speak clearly into the microphone.
OR
 Wait for the **PTT Sidetone** to finish (if enabled) and speak clearly into the microphone.
- 4 Release the **PTT** button to listen. When the target radio responds, the green LED blinks. You see the Group Call icon, the group alias or ID, and transmitting radio alias or ID on your display.
- 5  If the Channel Free Indication feature is enabled, you hear a short alert tone the moment the target radio releases

the **PTT** button, indicating the channel is free for you to respond. Press the **PTT** button to respond.

OR

If there is no voice activity for a predetermined period of time, the call ends.

- 6 Radio returns to the screen you were on prior to initiating the call.

*You can also make a Group Call via Contacts (see **Making a Group Call from Contacts** on page 34).*

Making a Private Call

While you can receive and/or respond to a Private Call initiated by an authorized individual radio, your radio must be programmed for you to initiate a Private Call.

There are two types of Private Calls. The first type, where a radio presence check is performed prior to setting up the call, while the other sets up the call immediately.

Only **one** of these call types can be programmed to your radio by your dealer.

You hear a negative indicator tone, when you make a Private Call via the Menu, Call Log, Contacts list, **One Touch Access** button, the programmed number keys, **Scroll Up/Down** buttons, or the **Volume/Channel Knob** if this feature is not enabled.

Use the Text Message or Call Alert features to contact an individual radio. See **Text Messaging Features** on page 48 or **Call Alert Operation** on page 41 for more information.

Procedure:

- 1 Select the channel with the active radio alias or ID. See **Selecting a Channel** on page 18.
OR
Press the programmed **One Touch Access** button.

- 2 Press the **PTT** button to make the call. The green LED lights up. The Private Call icon appears in the top right corner. The first text line shows the subscriber alias. The second text line displays the call status.

- 3 Wait for the Talk Permit Tone to finish (if enabled) and speak clearly into the microphone.

- 4 Release the **PTT** button to listen. When the target radio responds, the green LED blinks.

- 5 If the Channel Free Indication feature is enabled, you hear a short alert tone the moment the target radio releases the **PTT** button, indicating the channel is free for you to respond. Press the **PTT** button to respond.
OR
If there is no voice activity for a predetermined period of time, the call ends.

- 6 You hear a short tone. The display shows `Call Ended`.

You can also make a Private Call via Contacts (see **Making a Private Call from Contacts** on page 34), manually dial a Private Call (see **Making a Private Call by Manual Dial** on page 82) or perform a quick alphanumeric search for the required target alias via a keypad entry (see **Making a Group, Private, Phone or All Call by Alias Search** on page 83).

 **Making an All Call**

This feature allows you to transmit to all users on the channel. Your radio must be programmed to allow you to use this feature.

Procedure:

- 1 Select the channel with the active group alias or ID. See **Selecting a Channel** on page 18.

- 2 Press the **PTT** button to make the call. The green LED lights up. The Group Call icon appears in the top right corner. The first text line shows `All Call`.

- 3 Wait for the Talk Permit Tone to finish (if enabled) and speak clearly into the microphone.
OR
 Wait for the **PTT** Sidetone to finish (if enabled) and speak clearly into the microphone.

Users on the channel cannot respond to an All Call.

Making a Selective Call

Just like a Private Call, while you can receive and/or respond to a Selective Call initiated by an authorized individual radio, your radio must be programmed for you to initiate a Selective Call.

Procedure:

- 1 Select the channel with the active radio alias or ID. See **Selecting a Channel** on page 18.
- 2 Press the **PTT** button to make the call. The green LED lights up. The Private Call icon appears in the top right corner. The first text line shows the subscriber alias. The second text line displays the call status.
- 3 Wait for the Talk Permit Tone to finish (if enabled) and speak clearly into the microphone.
- 4 Release the **PTT** button to listen. When the target radio responds, the green LED blinks.
- 5 If the Channel Free Indication feature is enabled, you hear a short alert tone the moment the target radio releases the **PTT** button, indicating the channel is free for you to respond. Press the **PTT** button to respond.
OR
If there is no voice activity for a predetermined period of time, the call ends.
- 6 You hear a short tone. The display shows `Call Ended`.

Stopping a Radio Call

This feature allows you to stop an ongoing Group or Private Call to free the channel for transmission. For example, when a radio experiences a “stuck microphone” condition where the **PTT** button is inadvertently pressed by the user.

Your radio must be programmed to allow you to use this feature.

Procedure:

While on the required channel:

- 1 Press the programmed **Transmit Interrupt Remote Dekey** button.
- 2 The display shows `Remote Dekey`.
- 3 Wait for acknowledgment.
- 4 The radio sounds a positive indicator tone and the display shows `Remote Dekey Success`, indicating that the channel is now free.
OR
The radio sounds a negative indicator tone and the display shows `Remote Dekey Failed`.

*On the interrupted radio, the display shows `Call Interrupted`, and the radio sounds a negative indicator tone until you release the **PTT** button, if it is transmitting an interruptible call that is stopped via this feature.*

■ Talkaround

You can continue to communicate when your repeater is not operating, or when your radio is out of the repeater's range but within talking range of other radios. This is called "talkaround".

NOTE: This feature is not applicable in Capacity Plus and Linked Capacity Plus.



Procedure:



Press the programmed **Repeater/Talkaround** button to toggle between talkaround and repeater modes.



OR



Follow the procedure below.

- 1  to access the menu.

 - 2  or  to Utilities and press  to select.

 - 3  or  to Radio Settings and press  to select.

 - 4  or  to Talkaround and press  to select.

 - 5 Press  to enable Talkaround. The display shows ✓ beside Enabled.
- OR**
- Press  to disable Talkaround. The ✓ disappears from beside Enabled.
-
- 6 The screen automatically returns to the previous menu.

The Talkaround setting is retained even after powering down.

■ Permanent Monitor

Use the Permanent Monitor feature to continuously monitor a selected channel for activity.

NOTE: This feature is not applicable in Capacity Plus and Linked Capacity Plus.

Procedure:

- 1 Press the programmed **Permanent Monitor** button.

- 2 Radio sounds an alert tone, the yellow LED lights up, and the display shows Permanent Monitor On. The monitor icon appears on the status bar.

- 3 Press the programmed **Permanent Monitor** button to exit Permanent Monitor mode.

- 4 Radio sounds an alert tone, the yellow LED turns off, and display shows Permanent Monitor Off.

Advanced Features

Use this navigation guide to learn more about advanced features available with your radio:

Radio Check	page 26
Remote Monitor.	page 27
Scan Lists	page 29
Scan	page 31
Vote Scan	page 33
Contacts Settings	page 33
Call Indicator Settings	page 37
Call Log Features	page 40
Call Alert Operation.	page 41
Emergency Operation	page 43
Text Messaging Features	page 48
Analog Message Encode	page 57
Analog Status Update	page 58
Privacy	page 59
Multi-Site Controls.	page 60
Security	page 62
Lone Worker	page 64
Bluetooth	page 64
Notification List	page 67
Utilities.	page 67

Radio Check



If enabled, this feature allows you to determine if another radio is active in a system without disturbing the user of that radio. No audible or visual notification is shown on the target radio.

This feature is only applicable for subscriber aliases or IDs.

Sending a Radio Check

Procedure:

Use the programmed **Radio Check** button.



- 1 Press the programmed **Radio Check** button.
- 2  or  to the required subscriber alias or ID and press  to select.
- 3 The display shows transitional mini notice, indicating the request is in progress. The LED lights up solid green.
- 4 Wait for acknowledgement.
- 5 If successful, a positive indicator tone sounds and the display shows positive mini notice.
OR
If unsuccessful, a negative indicator tone sounds and the display shows negative mini notice.
- 6 Radio returns to the subscriber alias or ID screen.



OR



Procedure:

Use the menu.

- 1  to access the menu.

- 2  or  to **Contacts** and press  to select.

- 3  or  to the required subscriber alias or ID and press  to select.

- 4  or  to **Radio Check** and press  to select.

- 5 The display shows transitional mini notice, indicating the request is in progress. The green LED lights up.

- 6 Wait for acknowledgement.

- 7 If successful, a positive indicator tone sounds and the display shows positive mini notice.
OR
If unsuccessful, a negative indicator tone sounds and the display shows negative mini notice.

- 8 Radio returns to the subscriber alias or ID screen.

If the  button is pressed when the radio is waiting for acknowledgement, a tone sounds, and the radio terminates all retries and exits Radio Check mode.

You can also initiate Radio Check via manual dial (see **Initiating a Radio Check by Manual Dial** on page 81).

■ Remote Monitor

Use the Remote Monitor feature to turn on the microphone of a target radio (subscriber IDs only). No audible or visual indication is given to the target radio. You can use this feature to monitor, remotely, any audible activity surrounding the target radio.



Your radio must be programmed to allow you to use this feature.

Initiating Remote Monitor

Procedure:

Use the programmed **Remote Monitor** button.

- 1 Press the programmed **Remote Monitor** button.

- 2  or  to the required subscriber alias or ID and press  to select.

- 3 The display shows transitional mini notice, indicating the request is in progress. The green LED lights up.

- 4 Wait for acknowledgment.

- 5 If successful, a positive indicator tone sounds and the display shows positive mini notice. Your radio starts playing audio from the monitored radio for a programmed duration and display shows **Rem. Monitor**.
Once the timer expires, the radio sounds an alert tone and the LED turns off.
OR



If unsuccessful, a negative indicator tone sounds and the display shows negative mini notice.



OR



Procedure:

Use the menu.

- 1  to access the menu.

- 2  or  to **Contacts** and press  to select.

- 3  or  to the required subscriber alias or ID and press  to select.

- 4  or  to **Remote Mon.** and press  to select.

- 5 The display shows transitional mini notice, indicating the request is in progress. The green LED lights up.

- 6 Wait for acknowledgment.

- 7 If successful, a positive indicator tone sounds and the display shows positive mini notice. Your radio starts playing audio from the monitored radio for a programmed duration and display shows **Rem. Monitor**.
Once the timer expires, the radio sounds an alert tone and the LED turns off.

OR

If unsuccessful, the radio sounds a negative indicator tone the display shows negative mini notice.

You can also manually select a target radio address (see **Initiating Remote Monitor by Manual Dial** on page 81).

 **Stopping Remote Monitor**

Remote Monitor automatically stops after a programmed duration or when there is any user operation on the target radio.

Procedure:

- 1 Press the programmed **Transmit Interrupt Remote Dekey** button.

 - 2 The display shows transitional mini notice, indicating the request is in progress. The green LED lights up.

 - 3 Wait for acknowledgment.

 - 4 If successful, a positive indicator tone sounds and the display shows positive mini notice.
- OR**
- If unsuccessful, a negative indicator tone sounds and the display shows negative mini notice.
-

■ Scan Lists

Scan lists are created and assigned to individual channels/groups. Your radio scans for voice activity by cycling through the channel/group sequence specified in the scan list for the current channel/group.

Your radio can support up to 250 scan lists, with a maximum of 16 members in a list. Each scan list supports a mixture of both analog and digital entries.

You can add, delete, or prioritize channels by editing a scan list.



You can attach a new scan list to your radio via Front Panel Programming.



NOTE: This feature is not applicable in Capacity Plus and Linked Capacity Plus.



📄 Viewing an Entry in the Scan List

Procedure:

- 1  to access the menu.

- 2  or  to Scan and press  to select.

- 3  or  to Scan List and press  to select.

- 4 Use  or  to view each member on the list.

The priority icon appears left of the member's alias, if set, to indicate whether the member is on a Priority 1 or Priority 2

*channel list. You **cannot** have multiple Priority 1 or Priority 2 channels in a scan list.*



*There is no priority icon if priority is set to **None**.*



📄 Editing the Scan List



📄 Adding a New Entry to the Scan List



Procedure:



- 1  to access the menu.

 - 2  or  to Scan and press  to select.







 - 3  or  to Scan List and press  to select.

 - 4  or  to Add Member and press  to select.

 - 5  or  to the required alias or ID and press  to select.

 - 6  or  to the required priority level and press  to select.



 - 7 The display shows positive mini notice, followed immediately by Add Another?.



 - 8  or  to Yes and press  to select, to add another entry, and repeat Steps 5 and 6.
- OR**
-  or  to No and press  to select to save the current list.



Deleting an Entry from the Scan List



Procedure:



- 1  to access the menu.



- 2  or  to Scan and press  to select.

- 3  or  to Scan List and press  to select.

- 4  or  to the required alias or ID and press  to select.

- 5  or  to Delete and press  to select.

- 6 At Delete Entry?,  or  to Yes and press  to select, to delete the entry. The display shows positive mini notice.

- OR**
 or  to No and press  to select to return to the previous screen.



- 7 Repeat Steps 4 to 6 to delete other entries.



After deleting all required aliases or IDs, long press  to return to the Home screen.



Setting and Editing Priority for an Entry in the Scan List



Procedure:



- 1  to access the menu.

- 2  or  to Scan and press  to select.

- 3  or  to Scan List and press  to select.

- 4  or  to the required alias or ID and press  to select.

- 5  or  to Edit Priority and press  to select.

- 6  or  to the required priority level and press  to select.

- 7 The display shows positive mini notice before returning to the previous screen.

- 8 The priority icon appears left of the member's name.

There is no priority icon if priority is set to **None**.

■ Scan

When you start a scan, your radio cycles through the programmed scan list for the current channel looking for voice activity.

The yellow LED blinks and the scan icon appears on the status bar.

During a dual mode scan, if you are on a digital channel, and your radio locks onto an analog channel, it automatically switches from digital mode to analog mode for the duration of the call. This is also true for the reverse.

There are two ways of initiating scan:











- **Main Channel Scan (Manual):** Your radio scans all the channels/groups in your scan list. On entering scan, your radio may – depending on the settings – automatically start on the last scanned “active” channel/group or on the channel where scan was initiated.
- **Auto Scan (Automatic):** Your radio automatically starts scanning when you select a channel/group that has Auto Scan enabled.

NOTE: This feature is not applicable in Capacity Plus and Linked Capacity Plus.

📄 Starting and Stopping Scan

Procedure:

Press the programmed **Scan** button to start or stop Scan. **OR** Follow the procedure below.

- 1 Use the **Scroll Up/Down** buttons to select a channel programmed with a scan list.
- 2  to access the menu.
- 3  or  to Scan and press  to select.
- 4  or  to Scan State and press  to select.
- 5  or  to required scan state and press  to select.
- 6 The display shows *Scan On* when scan is enabled. The yellow LED blinks and the scan icon appears.
OR
The display shows *Scan Off* if scan is disabled. The LED turns off and the scan icon disappears.

While scanning, the radio can only accept data (e.g. text message, location, telemetry, or PC data) if received on its Selected Channel.

Responding to a Transmission During a Scan

During scanning, your radio stops on a channel/group where activity is detected. The radio stays on that channel for a programmed time period known as “hang time”.

Procedure:

- 1  If the Channel Free Indication feature is enabled, you hear a short alert tone the moment the transmitting radio releases the **PTT** button, indicating the channel is free for you to respond.

- 2 Press the **PTT** button during hang time. The green LED lights up.

- 3 Wait for the Talk Permit Tone to finish (if enabled) and speak clearly into the microphone.
OR
 Wait for the **PTT** Sidetone to finish (if enabled) and speak clearly into the microphone.

- 4 Release the **PTT** button to listen.

- 5 If you do not respond within the hang time, the radio returns to scanning other channels/groups.

Deleting a Nuisance Channel

If a channel continually generates unwanted calls or noise (termed a “nuisance” channel), you can temporarily remove the unwanted channel from the scan list.

This capability does not apply to the channel designated as the Selected Channel.

Procedure:

- 1 When your radio “locks on to” an unwanted or nuisance channel, press the programmed **Nuisance Channel Delete** button until you hear a tone.

- 2 Release the **Nuisance Channel Delete** button. The nuisance channel is deleted.

*Deleting a “nuisance” channel is **only** possible through the programmed **Nuisance Channel Delete** button. This feature is **not** accessible through the menu.*

Restoring a Nuisance Channel

Procedure:

To restore the deleted nuisance channel, do **one** of the following:

- Turn the radio off and then power it on again, **OR**
- Stop and restart a scan via the programmed **Scan** button or menu, **OR**
- Change the channel via the **Scroll Up/Down** buttons.

■ Vote Scan

Vote Scan provides you with wide area coverage in areas where there are multiple base stations transmitting identical information on different analog channels.

Your radio scans analog channels of multiple base stations and performs a voting process to select the strongest received signal. Once that is established, your radio unmutes to transmissions from that base station.

The yellow LED blinks and the vote scan icon appears on the status bar.

*To respond to a transmission during a Vote Scan, follow the same procedures as **Responding to a Transmission During a Scan** on page 32.*

■ Contacts Settings

Contacts provides “address-book” capabilities on your radio. Each entry corresponds to an alias or ID that you use to initiate a call.

Each entry, depending on context, associates with **one** of five types of calls: Group Call, Private Call, All Call, PC Call or Dispatch Call.

PC Call and Dispatch Call are data-related. They are only available with the applications. Refer to the data applications documentation for further details.

NOTE: If the Privacy feature is enabled on a channel, you can make privacy-enabled Group Call, Private Call, and All Call on that channel. Only target radios with the same Privacy Key OR the same Key Value and Key ID as your radio are able to unscramble the transmission.

See **Privacy** on page 59 for more information. 

Additionally, Contacts menu allows you to assign each entry to a programmable number key or more on a keypad microphone. If an entry is assigned to a number key, your radio can perform a quick dial on the entry. 

Your radio supports two Contacts lists, one for Analog contacts and one for Digital contacts, with a maximum of 500 members for each Contacts list.

Each entry within Contacts displays the following information:







- Call Type
- Call Alias
- Call ID

NOTE: You can add, or edit subscriber IDs for the Digital Contacts list. Deleting subscriber IDs can only be performed by your dealer.

For the Analog Contacts list, you can only view the subscriber IDs, edit the subscriber IDs, and initiate a Call Alert. Adding and deleting capabilities can only be performed by your dealer.

Making a Group Call from Contacts

Procedure:

- 1  to access the menu.
- 2  or  to **Contacts** and press  to select. The entries are alphabetically sorted.
- 3  or  to the required group alias or ID.

- 4 Press the **PTT** button to make the call. The green LED lights up.

- 5 Wait for the Talk Permit Tone to finish (if enabled) and speak clearly into the microphone.

OR

- 5  Wait for the **PTT** Sidetone to finish (if enabled) and speak clearly into the microphone.

- 6 Release the **PTT** button to listen. When any user in the group responds, the green LED blinks. You see the Group Call icon, the group alias or ID, and that user's alias or ID on your display.





- 7  If the Channel Free Indication feature is enabled, you hear a short alert tone the moment the target radio releases the **PTT** button, indicating the channel is free for you to respond. Press the **PTT** button to respond.



OR

If there is no voice activity for a programmed period of time, the call ends.

Making a Private Call from Contacts

Procedure:

- 1  to access the menu.
- 2  or  to **Contacts** and press  to select. The entries are alphabetically sorted.

- 3  or  to the required subscriber alias or ID.
- 4 Press the **PTT** button to make the call. The green LED lights up. The display shows the destination alias.
- 5 Wait for the Talk Permit Tone to finish (if enabled) and speak clearly into the microphone.
- 6 Release the **PTT** button to listen. When the target radio responds, the green LED blinks and the display shows the transmitting user's alias or ID.
- 7 If the Channel Free Indication feature is enabled, you hear a short alert tone the moment the target radio releases the **PTT** button, indicating the channel is free for you to respond. Press the **PTT** button to respond.
OR
If there is no voice activity for a programmed period of time, the call ends.
- 8 You hear a short tone. The display shows `Call Ended`.

















NOTE: If you release the **PTT** button while the radio is setting up the call, it exits without any indication and returns to the previous screen.

Your radio may be programmed to perform a radio presence check prior to setting up the Private Call. If the target radio is not available, you hear a short tone and see negative mini notice on the display.

The radio returns to the menu prior to initiating the radio presence check.

Assigning an Entry to a Programmable Number Key

Procedure:

- 1  to access the menu.
- 2  or  to `Contacts` and press  to select. The entries are alphabetically sorted.
- 3  or  to the required alias or ID and press  to select.
- 4  or  to `Program Key` and press  to select.
- 5  or  to the desired number key and press  to select.
OR
If the number key is currently assigned to another entry, the display shows `The Key is Already Used` and then, the first line of the display shows `Overwrite?`.
 or  to `Yes` and press  to select.
- 6 The radio sounds a positive indicator tone and the display shows positive mini notice.
- 7 The screen automatically returns to the previous menu.

NOTE: Each entry can be associated to different number keys. You see a checkmark before each number key that is assigned to an entry. If the checkmark is before **Empty**, you have not assign a number key to the entry.

If a number key is assigned to an entry in a particular mode, this feature is not supported when you long press the number key in another mode.

See **Making a Group, Private or All Call with the Programmable Number Key** on page 82 for details on making a Group, Private or All Call with the programmed number keys.

Removing the Association between Entry and Programmable Number Key



Procedure:



Long press the programmed number key to the required alias or ID, press  to select, and proceed to Step 4.



OR



Follow the procedure below.

- 1  to access the menu.



- 2  or  to **Contacts** and press  to select. The entries are alphabetically sorted.

- 3  or  to the required alias or ID and press  to select.

- 4  or  to **Program Key** and press  to select.

- 5  or  to **Empty** and press  to select.

- 6 The first line of the display shows **Clear from all keys?**

- 7  or  to **Yes** and press  to select.

- 8 The radio sounds a positive indicator tone and the display shows positive mini notice.

- 9 The screen automatically returns to the previous menu.



NOTE: When an entry is deleted, the association between the entry and its programmed number key(s) is removed.



Setting Default Contact



Procedure:

Follow the procedure below.

- 1  to access the menu.

- 2  or  to **Contacts** and press  to select.

- 3  or  to the required alias or ID and press  to select.

- 4  or  to **Set as Default** and press  to select.

- 5 The radio sounds a positive indicator tone and the display shows positive mini notice.

- 6 A  appears beside the selected default alias or ID.



■ Call Indicator Settings



📄 Activating or Deactivating Call Ringers for Call Alerts



You can select, or turn on or off ringing tones for a received Call Alert.



Procedure:



- 1  to access the menu.



- 2  or  to Utilities and press  to select.

- 3  or  to Radio Settings and press  to select.

- 4  or  to Tones/Alerts and press  to select.

- 5  or  to Call Ringers and press  to select.

- 6  or  to Call Alert and press  to select. The current tone is indicated by a ✓.



- 7  or  to the required tone and press  to select. ✓ appears beside selected tone.



📄 Activating or Deactivating Call Ringers for Private Calls



You can turn on or off the ringing tones for a received Private Call.



Procedure:



- 1  to access the menu.



- 2  or  to Utilities and press  to select.

- 3  or  to Radio Settings and press  to select.

- 4  or  to Tones/Alerts and press  to select.

- 5  or  to Call Ringers and press  to select.

- 6  or  to Private Call.



- 7 Press  to enable Private Call ringing tones. The display shows ✓ beside Enabled.
OR
 Press  to disable Private Call ringing tones. The ✓ disappears from beside Enabled.



📄 Activating or Deactivating Call Ringers for Selective Call













You can select, or turn on or off ringing tones for a received Selective Call.

Procedure:

- 1  to access the menu.

- 2  or  to Utilities and press  to select.



















- 3  or  to Radio Settings and press  to select.

- 4  or  to Tones/Alerts and press  to select.
- 5  or  to Call Ringers and press  to select.
- 6  or  to Selective Call and press  to select. The current tone is indicated by a ✓.
- 7  or  to the required tone and press  to select. ✓ appears beside selected tone.

Activating or Deactivating Call Ringers for Text Message

You can turn on or off the ringing tones for a received Text Message.



















Procedure:

- 1  to access the menu.
- 2  or  to Utilities and press  to select.
- 3  or  to Radio Settings and press  to select.
- 4  or  to Tones/Alerts and press  to select.
- 5  or  to Call Ringers and press  to select.
- 6  or  to Messages and press  to select. The current tone is indicated by a ✓.
- 7  or  to the required tone and press  to select. ✓ appears beside selected tone.

Activating or Deactivating Call Ringers for Telemetry Status with Text

You can turn on or off the alert tones for a received Telemetry Status with Text.

Procedure:



- 1  to access the menu.
- 2  or  to Utilities and press  to select.
- 3  or  to Radio Settings and press  to select.
- 4  or  to Tones/Alerts and press  to select.
- 5  or  to Call Ringers and press  to select.
- 6  or  to Telemetry and press  to select. The current tone is indicated by a ✓.
- 7  or  to the required tone and press  to select. ✓ appears beside selected tone.



Assigning Ring Styles



You can program your radio to sound one of ten predefined ringing tones when receiving a Call Alert or a Text Message from a particular contact.

Procedure:

- 1  to access the menu.



- 2  or  to **Contacts** and press  to select. The entries are alphabetically sorted.

- 3  or  to the required alias or ID and press  to select.

- 4  or  to **Edit** and press  to select.

- 5 Press  until display shows **Edit Ringtone** menu.

- 6 A ✓ indicates the current selected tone.

- 7  or  to the required tone and press  to select. ✓ appears beside selected tone.

- 8 The display shows a positive mini notice.



The radio sounds out each ring style as you navigate through the list.



Escalating Alarm Tone Volume



You can program your radio to continually alert you when a radio call remains unanswered. This is done by automatically increasing the alarm tone volume over time. This feature is known as Escalert.



Procedure:



- 1  to access the menu.

- 2  or  to **Utilities** and press  to select.

- 3  or  to **Radio Settings** and press  to select.

- 4  or  to **Tones/Alerts** and press  to select.

- 5  or  to **Escalert**.

- 6 Press  to enable Escalert. The display shows ✓ beside Enabled.
OR
 Press  to disable Escalert. The ✓ disappears from beside Enabled.

■ Call Log Features

Your radio keeps track of all recent outgoing, answered, and missed Private Calls. Use the call log feature to view and manage recent calls.









You can perform the following tasks in each of your call lists:

- Store alias or ID to Contacts
- Delete
- View Details

Viewing Recent Calls

The lists are Missed, Answered, and Outgoing.

















Procedure:

- 1  to access the menu.
- 2  or  to Call Log and press  to select.
- 3  or  to preferred list and press  to select.
- 4 The display shows the most recent entry at the top of the list.
- 5  or  to view the list.

Press the **PTT** button to start a Private Call with the current selected alias or ID.

Deleting a Call from a Call List

Procedure:



- 1  to access the menu.
- 2  or  to Call Log and press  to select.
- 3  or  to the required list and press  to select.
- 4  or  to the required alias or ID and press  to select.
- 5  or  to Delete and press  to select.
- 6 Press  to select Yes to delete the entry. The display shows positive mini notice.
OR
 or  to No to return to the previous screen.



When you select a call list and it contains no entries, the display shows *List Empty*, and sounds a low tone if Keypad Tones are turned on (see **Turning Keypad Tones On or Off** on page 80).



Viewing Details from a Call List



Procedure:

- 1  to access the menu.

- 2  or  to Call Log and press  to select.

- 3  or  to the required list and press  to select.

- 4  or  to the required alias or ID and press  to select.

- 5  or  to View Details and press  to select.
Display shows details.

■ Call Alert Operation

Call Alert paging enables you to alert a specific radio user to call you back when they are able to do so.

This feature is applicable for subscriber aliases or IDs only and is accessible through the menu via Contacts or manual dial.

Receiving and Responding to a Call Alert

When you receive a Call Alert page, you see the notification list listing a Call Alert with the alias or ID of the calling radio on the display.

Procedure:

- 1 You hear a repetitive tone. The yellow LED blinks.

- 2 Press the **PTT** button while the display still shows the Call Alert in the Notification List to respond with a Private Call.
OR
Press  to exit the Notification List. The alert is moved to the Missed Call Log.



See **Notification List** on page 67 for details about the Notification List.



See **Call Log Features** on page 40 for details about the Missed Call List.



Making a Call Alert from the Contacts List

Procedure:

- 1  to access the menu.

- 2  or  to **Contacts** and press  to select.

- 3  or  to the required subscriber alias or ID and press  to select.

- 4  or  to **Call Alert** and press  to select.

- 5 The display shows **Call Alert** and the subscriber alias or ID, indicating that the Call Alert has been sent.

- 6 The green LED lights up when your radio is sending the Call Alert.

- 7 If the Call Alert acknowledgement is received, the display shows positive mini notice.
OR
If the Call Alert acknowledgement is not received, the display shows negative mini notice.

*You can also send a Call Alert by manually dialing the subscriber ID (see **Making a Call Alert by Manual Dial** on page 87).*

Making a Call Alert with the One Touch Access Button

Procedure:

- 1 Press the programmed **One Touch Access** button to make a Call Alert to the predefined alias or ID.

- 2 The display shows **Call Alert** and the subscriber alias or ID, indicating that the Call Alert has been sent.

- 3 The green LED lights up when your radio is sending the Call Alert.

- 4 If the Call Alert acknowledgement is received, the display shows positive mini notice.
OR
If the Call Alert acknowledgement is not received, the display shows negative mini notice.

■ Emergency Operation

An Emergency Alarm is used to indicate a critical situation. You are able to initiate an Emergency at any time on any screen display even when there is activity on the current channel.

Your dealer can set the duration of a button press for the programmed **Emergency** button, except for long press, which is similar with all other buttons:

- Short press – Between 0.05 seconds and 0.75 seconds
- Long press – Between 1.00 second and 3.75 seconds

The **Emergency** button is assigned with the Emergency On/ Off feature. Check with your dealer for the assigned operation of the **Emergency** button.

*If short press the **Emergency** button is assigned to turn on the Emergency mode, then long press the **Emergency** button is assigned to exit the Emergency mode.*

*If long press the **Emergency** button is assigned to turn on the Emergency mode, then short press the **Emergency** button is assigned to exit the Emergency mode.*

Your radio supports **three** Emergency Alarms:

- Emergency Alarm
- Emergency Alarm with Call
- Emergency Alarm with Voice to Follow 





In addition, each alarm has the following types:

- **Regular** – Radio transmits an alarm signal and shows audio and/or visual indicators.
- **Silent** – Radio transmits an alarm signal without any audio or visual indicators. Radio receives calls without any sound through the radio's speaker, until you press the **PTT** button to initiate the call.
- **Silent with Voice** – Radio transmits an alarm signal without any audio or visual indicators, but allow incoming calls to sound through the radio's speaker.



Only **one** of the Emergency Alarms above can be assigned to the programmed **Emergency** button or the **Emergency** footswitch.



Receiving an Emergency Alarm

Procedure:

- 1 The emergency icon appears, a tone sounds, the red LED blinks, and the radio displays the Alarm List if there is more than one alarm listed. The emergency caller aliases are listed.  or  to the required alias and press  to view more details. Press  again to view your action options.

OR





The emergency icon appears, a tone sounds, the red LED blinks, and the radio displays the emergency caller alias. Press  to view more details. Press  again to view your action options.

- Press  and select **Yes** to exit the Alarm List.
To revisit the Alarm List, press  to access the menu and select **Alarm List**.
-

Responding to an Emergency Alarm

Procedure:

When receiving an Emergency Alarm:

- In the Alarm List,  or  to the required alias.
-  If the Channel Free Indication feature is enabled, you hear a short alert tone the moment the transmitting radio releases the **PTT** button, indicating the channel is free for you to respond.
- Press **PTT** button to transmit non-emergency voice to the same group that the Emergency Alarm was targeted to. The green LED lights up. Your radio remains in the Emergency mode.
- Wait for the Talk Permit Tone to finish (if enabled) and speak clearly into the microphone.
OR
 Wait for the **PTT** Sidetone to finish (if enabled) and speak clearly into the microphone.
- Release the **PTT** button to listen. When the emergency initiating radio responds, the green LED blinks. You see the

Group Call icon, the group alias or ID, and transmitting radio alias or ID on your display.

- Your radio displays the Alarm List.
-

Emergency voice can only be transmitted by the emergency initiating radio. All other radios (including the emergency receiving radio) transmit non-emergency voice.

Sending an Emergency Alarm

This feature allows you to send an Emergency Alarm, a non-voice signal, which triggers an alert indication on a group of radios.

Procedure:

- Press the programmed **Emergency On** button or the **Emergency** footswitch.
- The display shows **Tx Alarm** and the destination alias. The green LED lights up and the Emergency icon appears.
OR
 The display shows **Tx Telegram** and the destination alias. The LED lights up solid green and the Emergency icon appears.
- When an Emergency Alarm acknowledgment is received, the Emergency tone sounds and the green LED blinks. The display shows **Alarm Sent**.
OR
If your radio does not receive an Emergency Alarm

acknowledgement, and after all retries have been exhausted, a tone sounds and the display shows **Alarm Failed**.

- 4 Radio exits the Emergency Alarm mode and returns to the Home screen.

If your radio is set to Silent, it does not display any audio or visual indicators during Emergency mode.

Sending an Emergency Alarm with Call

This feature allows you to send an Emergency Alarm to a group of radios. Upon acknowledgement by a radio within the group, the group of radios can communicate over a programmed Emergency channel.

Procedure:

- 1 Press the programmed **Emergency On** button or the **Emergency** footswitch.
- 2 The display shows **Tx Alarm** and the destination alias. The green LED lights up and the Emergency icon appears.
OR
 The display shows **Tx Telegram** and the destination alias. The LED lights up solid green and the Emergency icon appears.
- 3 When an Emergency Alarm acknowledgment is received, the Emergency tone sounds and the green LED blinks. The display shows **Alarm Sent**.

- 4 Your radio enters the emergency call mode when the display shows **Emergency** and the destination group alias.

- 5 Press **PTT** button to make the call. The green LED lights up and the group icon appears on the display.

- 6 Wait for the Talk Permit Tone to finish (if enabled) and speak clearly into the microphone.

OR

-  Wait for the **PTT** Sidetone to finish (if enabled) and speak clearly into the microphone.

- 7 Release the **PTT** button to listen.
When you receive a group call, the display shows the caller alias and group alias.

- 8 When the channel is free for you to respond, a short alert tone sounds ( if the Channel Free Indication feature is enabled). Press the **PTT** button to respond.

OR

- Once your call ends, press **Emergency Off** button to exit the Emergency mode.

- 9 The radio returns to the Home screen.

*If your radio is set to Silent, it does not display any audio or visual indicators during Emergency mode, or allow any received calls to sound through the radio's speaker, until you press the **PTT** button to initiate the call.*

If your radio is set to Silent with Voice, it does not display any audio or visual indicators during Emergency mode, but allow incoming calls to sound through the radio's speaker. The indicators only appear once you press the **PTT** button to initiate, or respond to, the call.

Sending an Emergency Alarm with Voice to Follow

This feature allows you to send an Emergency Alarm to a group of radios. Your radio's microphone is automatically activated, allowing you to communicate with the group of radios without pressing the **PTT** button.

This activated microphone state is also known as "hot mic".

If your radio has Emergency Cycle Mode enabled, repetitions of hot mic and receiving period are made for a programmed duration.

NOTE: During Emergency Cycle Mode, received calls sound through the radio's speaker.

If you press the **PTT** button during the programmed receiving period, you will hear a prohibit tone, indicating that you should release the **PTT** button. The radio ignores the **PTT** press and remains in Emergency mode.

NOTE: If you press the **PTT** button during hot mic, and continue to press it after the hot mic duration expires,

the radio continues to transmit until you release the **PTT** button.

Procedure:

- 1 Press the programmed **Emergency On** button or the **Emergency** footswitch.

- 2 The display shows Tx Alarm and the destination alias. The green LED lights up and the Emergency icon appears.
OR
 The display shows Tx Telegram and the destination alias. The LED lights up solid green and the Emergency icon appears.

- 3 Once the display shows Alarm Sent, speak clearly into the microphone. When hot mic has been enabled, the radio automatically transmits without a **PTT** press until the hot mic duration expires.
While transmitting, the green LED lights up and the Emergency icon appears.

- 4 The radio automatically stops transmitting when:
Once the cycling duration between hot mic and receiving calls expires, if Emergency Cycle Mode is enabled.
OR
Once the hot mic duration expires, if Emergency Cycle Mode is disabled.

- 5 To transmit again, press the **PTT** button.
OR

Press the programmed **Emergency Off** button to exit the Emergency mode.

6 The radio returns to the Home screen.

*If your radio is set to Silent, it does not display any audio or visual indicators during Emergency mode, or allow any received calls to sound through the radio's speaker, until the programmed hot mic transmission period is over, and you press the **PTT** button.*

*If your radio is set to Silent with Voice, it does not display any audio or visual indicators during Emergency mode when you are making the call with hot mic, but allow sound through the radio's speaker when the target radio responds after the programmed hot mic transmission period is over. The indicators only appear when you press the **PTT** button.*

NOTE: If the Emergency Alarm request fails, the radio does not retry to send the request, and enters the hot mic state directly.

Reinitiating an Emergency Mode

NOTE: This feature is only applicable to the radio sending the Emergency Alarm.

There are two instances where this can happen:

- You change the channel while the radio is in Emergency mode. This exits the Emergency mode. If Emergency Alarm is enabled on this new channel, the radio reinitiates Emergency.
- You press the programmed **Emergency On** button during an Emergency initiation/transmission state. This causes the radio to exit this state, and to reinitiate Emergency.

Exiting Emergency Mode

NOTE: This feature is only applicable to the radio sending the Emergency Alarm.

Your radio exits Emergency mode when **one** of the following occurs:

- Emergency Alarm acknowledgement is received (for **Emergency Alarm** only), **OR**
-  An Emergency Exit Telegram is received, **OR**
- All retries to send the alarm have been exhausted, **OR**
- The **Emergency Off** button is pressed.

NOTE: If your radio is powered off, it exits the Emergency mode. The radio does not reinitiate the Emergency mode automatically when it is turned on again.

If you change channels when your radio is in Emergency mode to a channel that has no emergency system configured, No Emergency is shown on your display.

Text Messaging Features

Your radio is able to receive data, for example a text message, from another radio or an e-mail application.

Sending a Quick Text Message

Your radio supports a maximum of 50 Quick Text messages as programmed by your dealer.













NOTE: While Quick Text messages are programmed, you can edit each message before sending it. Only available with a keypad microphone (see *Editing a Quick Reply Message* on page 89).

Procedure:

Press the programmed **Text Message** button and proceed to Step 3.

OR

Follow the procedure below.

- 1  to access the menu.
- 2  or  to Messages and press  to select.
- 3  or  to Quick Text and press  to select.
- 4  or  to the required Quick Text and press  to select.
- 5  or  to the required alias or ID and press  to select.

- 6 The display shows transitional mini notice, confirming your message is being sent.
-
- 7 If the message is sent, a tone sounds and the display shows positive mini notice.
- OR**
- If the message is not sent, a low tone sounds and the display shows negative mini notice.
-

*If the text message fails to send, the radio returns you to the Resend option screen (see **Managing Fail-to-Send Text Messages** on page 50).*

Sending a Quick Text Message with the One Touch Access Button

- 1 Press the programmed **One Touch Access** button to send a predefined Quick Text message to a predefined alias or ID.
-
- 2 The display shows transitional mini notice, confirming your message is being sent.
-
- 3 If the message is sent, a tone sounds and the display shows positive mini notice.
- OR**
- If the message is not sent, a low tone sounds and the display shows negative mini notice.
-

*If the text message fails to send, the radio returns you to the Resend option screen (see **Managing Fail-to-Send Text Messages** on page 50).*

Managing Text Messages in the Drafts Folder

The Drafts folder stores a maximum of ten (10) last saved messages. When the folder is full, the next saved text message automatically replaces the oldest text message in the folder. See **Accessing the Drafts Folder** on page 89 for more information.

NOTE: You can edit a saved text message before sending it. Only available with a keypad microphone (see **Editing and Sending a Saved Text Message** on page 90).

Long press  at any time to return to the Home screen.





Viewing a Saved Text Message







Procedure:

Press the programmed **Text Message** button and proceed to Step 3.

OR

Follow the procedure below.

- 1  to access the menu.
-
- 2  or  to Messages and press  to select.
-

- 3  or  to Drafts and press  to select.
- 4  or  to the required message and press  to select.















Deleting a Saved Text Message from Drafts

Procedure:

Press the programmed **Text Message** button and proceed to Step 3.

OR

Follow the procedure below.

- 1  to access the menu.
- 2  or  to Messages and press  to select.
- 3  or  to Drafts and press  to select.
- 4  or  to the required message and press  to select.
- 5 Press  again while viewing the message.
- 6  or  to Delete and press  to delete the text message.

Managing Fail-to-Send Text Messages

You can select one of the following options while at the Resend option screen:

- Resend
- Forward

- Edit (Only available with a keypad microphone – see **Editing a Text Message** on page 91 for more information)

NOTE: If the channel type (i.e. conventional digital or Capacity Plus or Linked Capacity Plus) is not a match, you can only edit and forward a Fail-to-Send message.

Resending a Text Message







Procedure:

- 1 Press  to resend the same message to the same subscriber/group alias or ID.
 - 2 If the message is sent successfully, a tone sounds and the display shows positive mini notice.
- OR**
If the message cannot be sent, the display shows negative mini notice.

Forwarding a Text Message

Select Forward to send the message to another subscriber/group alias or ID.

Procedure:

- 1  or  to Forward and press  to select.
- 2  or  to the required alias or ID and press  to select.

3 The display shows transitional mini notice, confirming your message is being sent.

4 If the message is sent, a tone sounds and the display shows positive mini notice.

OR

If the message is not sent, a low tone sounds and the display shows negative mini notice.

You can also manually select a target radio address (see **Forwarding a Text Message by Manual Dial** on page 90).

Managing Sent Text Messages

Once a message is sent to another radio, it is saved in Sent Items. The most recent sent text message is always added to the top of the Sent Items list.

The Sent Items folder is capable of storing a maximum of thirty (30) last sent messages. When the folder is full, the next sent text message automatically replaces the oldest text message in the folder.

NOTE: Long press  at any time to return to the Home screen.

Viewing a Sent Text Message

Procedure:



Press the programmed **Text Message** button and proceed to Step 3.



OR

Follow the procedure below.

1  to access the menu.

2  or  to Messages and press  to select.

3  or  to Sent Items and press  to select.

4  or  to the required message and press  to select.

A subject line may be shown if the message is from an e-mail application.

The icon beside each message indicates the status of the message (see **Sent Item Icons** on page 14).

Sending a Sent Text Message



You can select one of the following options while viewing a sent text message:

- Resend
- Forward
- Edit
- Delete

NOTE: If the channel type (i.e. conventional digital or Capacity Plus or Linked Capacity Plus) is not a match, you can only edit, forward, or delete a Sent message.

Procedure:



- 1 Press  again while viewing the message.

- 2  or  to Resend and press  to select.

- 3 The display shows transitional mini notice, confirming that the same message is being sent to the same target radio.



- 4 If the message is sent, a tone sounds and the display shows positive mini notice.
OR
If the message is not sent, a low tone sounds and the display shows negative mini notice.

If the text message fails to send, the radio returns you to the Resend option screen. Press  to resend the message to the same subscriber/group alias or ID.

NOTE: Changing the volume, and pressing any button, except for , , or , returns you to the message.

The radio exits the Resend option screen if you press the **PTT** button to initiate a Private or Group Call, or to respond to a Group Call. It also exits the screen when the radio receives a text or telemetry message, an emergency call or alarm, or a call alert.

The display returns to the Resend option screen if you press the **PTT** button to respond to a Private Call (except if the radio is displaying the Missed Call screen), and at the end of an All Call.

Press  or  to access the Forward, Edit, or Delete option screen:

- Select *Forward* to send the selected text message to another target radio (see **Forwarding a Text Message** on page 50). You can also manually select a target radio address using a keypad microphone (see **Forwarding a Text Message by Manual Dial** on page 90).
- Select *Edit* to edit the selected text message before sending it (see **Editing a Text Message** on page 91). Only available with a keypad microphone.
- Select *Delete* to delete the text message.

NOTE: If you exit the message sending screen while the message is being sent, the radio updates the status of the message in the Sent Items folder without providing any indication in the display or via sound.

If the radio changes mode or powers down before the status of the message in Sent Items is updated, the radio cannot complete any In-Progress messages and automatically marks it with a Send Failed icon.

The radio supports a maximum of five (5) In-Progress messages at one time. During this period, the radio cannot send any new message and automatically marks it with a Send Failed icon.

Deleting All Sent Text Messages from Sent Items



Procedure:



Press the programmed **Text Message** button and proceed to Step 3.



OR







Follow the procedure below.

- 1  to access the menu.

 - 2  or  to Messages and press  to select.

 - 3  or  to Sent Items and press  to select.

 - 4  or  to Delete All and press  to select.

 - 5  or  to Yes and press  to select. The display shows positive mini notice
- OR**
-  or  to No and press  to return to the previous screen.

*When you select Sent Items and it contains no text messages, the display shows **List Empty**, and sounds a low tone if Keypad Tones are turned on (see **Turning Keypad Tones On or Off** on page 80).*

Receiving a Text Message

When your radio receives a message, the display shows the Notification List with the alias or ID of the sender and the message icon.



You can select one of the following options when receiving a text message:

- Read
- Read Later
- Delete



NOTE: The radio exits the Text Message alert screen and sets up a Private or Group Call to the sender of the message if the **PTT** button is pressed when the radio is displaying the alert screen.



Reading a Text Message

Procedure:

- 1  or  to Read and press  to select.

 - 2 Selected message in the Inbox opens.
A subject line may be shown if the message is from an e-mail application.

 - 3 Press  to return to the Inbox.
- OR**
- Press  to reply, forward, or delete the text message.

Press  or  to access the *Read Later* or *Delete* option screen:

- Select *Read Later* to return to the screen you were on prior to receiving the text message.
- Select *Delete* to delete the text message.

Managing Received Text Messages

Use the Inbox to manage your text messages. The Inbox is capable of storing a maximum of 30 messages.

Your radio supports the following options for text messages:

- Reply (via Quick Text)
- Forward
- Delete
- Delete All

NOTE: If the channel type (i.e. conventional digital or Capacity Plus or Linked Capacity Plus) is not a match, you can only forward, delete, or delete all Received messages.



Text messages in the Inbox are sorted according to the most recently received.



NOTE: Long press  at any time to return to the Home screen.



Viewing a Text Message from the Inbox



Procedure:

- 1  to access the menu.

- 2  or  to *Messages* and press  to select.

- 3  or  to *Inbox* and press  to select.



- 4  or  to view the messages.
A subject line may be shown if the message is from an e-mail application.



- 5 Press  to select the current message, and press  again to reply, forward, or delete that message.
OR
Long press  to return to the Home screen.



Viewing a Telemetry Status Text Message from the Inbox

Procedure:

- 1  to access the menu.

- 2  or  to *Messages* and press  to select.

- 3  or  to *Inbox* and press  to select.

- 4  or  to the required message and press  to select.

- 5 The display shows *Telemetry: <Status Text Message>*.

- 6 Long press  to return to the Home screen.

You cannot reply to a Telemetry Status text message.

Replying to a Text Message with Quick Text



Procedure:



Press the programmed **Text Message** button and proceed to Step 3.



OR

Follow the procedure below.



- 1  to access the menu.



- 2  or  to **Messages** and press  to select.



- 3  or  to **Inbox** and press  to select.

- 4  or  to the required message and press  to select.
A subject line may be shown if the message is from an e-mail application.

- 5 Press  once more to access the sub-menu.

- 6  or  to **Reply** and press  to select.

- 7  or  to **Quick Reply** and press  to select.

- 8  or  to the required message and press  to select.

- 9 The display shows transitional mini notice, confirming your message is being sent.

- 10 If the message is sent successfully, a tone sounds and the display shows positive mini notice.

OR

If the message cannot be sent, the display shows negative mini notice.

*If the text message fails to send, the radio returns you to the **Resend** option screen (see **Managing Fail-to-Send Text Messages** on page 50).*

NOTE: If you are using a keypad microphone, you can also write and send a new message (see **Writing and Sending a Text Message** on page 87) or modify a Quick Text message before sending it (see **Editing a Quick Reply Message** on page 89).

Deleting a Text Message from the Inbox



Procedure:



Press the programmed **Text Message** button and proceed to Step 3.



OR

Follow the procedure below.



- 1  to access the menu.



- 2  or  to Messages and press  to select.

- 3  or  to Inbox and press  to select.

- 4  or  to the required message and press  to select.
A subject line may be shown if the message is from an e-mail application.

- 5 Press  once more to access the sub-menu.

- 6  or  to Delete and press  to select.

- 7  or  to Yes and press  to select.

- 8 The display shows positive mini notice.

- 9 The screen returns to the Inbox.

Deleting All Text Messages from the Inbox



Procedure:



Press the programmed **Text Message** button and proceed to Step 3.



OR



Follow the procedure below.

- 1  to access the menu.

- 2  or  to Messages and press  to select.

- 3  or  to Inbox and press  to select.

- 4  or  to Delete All and press  to select.

- 5  or  to Yes and press  to select.

- 6 The display shows positive mini notice.

*When you select the Inbox and it contains no text messages, the display shows *List Empty*, and sounds a low tone if Keypad Tones are turned on (see **Turning Keypad Tones On or Off** on page 80).*

NOTE: Additional text messaging features are available with a keypad-enabled microphone. Refer to **Text Messaging** on page 87 for more details.



■ Analog Message Encode



Your radio is able to send preprogrammed messages from the Message list to a radio alias or to the dispatcher.



Sending MDC Message Encode to Dispatcher

Procedure:

- 1  to access the menu.

- 2  or  to Message and press  to select.

- 3  or  to Quick Text and press  to select.

- 4  or  to the required message. Press  to send.



- 5 The display shows transitional mini notice, confirming your message is being sent.



- 6 If the message is sent, a tone sounds and the display shows positive mini notice.
OR
If the message is not sent, a low tone sounds and the display shows negative mini notice.



Sending 5-Tone Message Encode to Contact



Procedure:

- 1  to access the menu.

- 2  or  to Message and press  to select.

- 3  or  to Quick Text and press  to select.

- 4  or  to the required message. Press  to select.

- 5  or  to the required contact. Press  to select.

- 6 The display shows transitional mini notice, confirming your message is being sent.

- 7 If the message is sent, a tone sounds and the display shows positive mini notice.
OR
If the message is not sent, a low tone sounds and the display shows negative mini notice.

■ Analog Status Update



Your radio is able to send preprogrammed messages from the Status List indicating your current activity to a radio contact (for 5-Tone systems) or to the dispatcher (for MDC systems).



The last acknowledged message is kept at the top of the Status List. The other messages are arranged in alphanumeric order.



Sending Status Update to Predefined Contact

Procedure:

- 1  to access the menu.

- 2  or  to Status and press  to select.

- 3  or  to the required status. Press  to select.

- 4  or  to Set as Default. Press  to send the status update.

- 5 The display shows transitional mini notice, confirming your status update is being sent.

- 6 If the status update is acknowledged, a tone sounds and the display shows positive mini notice. A ✓ appears beside the acknowledged status.
OR
 If the status update is not acknowledged, a low tone sounds and the display shows negative mini notice. A ✓ remains beside the previous status.



For 5-Tone systems, see **Setting Default Contact** on page 36 for details on setting the default contact.



For 5-Tone systems, a **PTT** button press while in the status list sends the selected status update and returns to the Home screen to initiate a voice call.



Viewing 5-Tone Status Details

Procedure:

- 1  to access the menu.

- 2  or  to Status and press  to select.

- 3  or  to the required status. Press  to select.

- 4  or  to View Details. Press  to select.

- 5 The display shows details of the selected status.

NOTE: If you are using a keypad microphone, you can modify the status details before sending it (see **Editing a Quick Reply Message** on page 89).

■ Privacy

If enabled, this feature helps to prevent eavesdropping by unauthorized users on a channel by the use of a software-based scrambling solution. The signaling and user identification portions of a transmission are not scrambled.

Your radio must have privacy enabled on the channel to send a privacy-enabled transmission, although this is not a necessary requirement for receiving a transmission. While on a privacy-enabled channel, the radio is still able to receive clear (unscrambled) transmissions.

Your radio supports two types of privacy:

- Basic Privacy
- Enhanced Privacy.

Only **ONE** of the privacy types above can be assigned to the radio.

To unscramble a privacy-enabled call or data transmission, your radio must be programmed to have the same Privacy Key (for Basic Privacy), OR the same Key Value and Key ID (for Enhanced Privacy) as the transmitting radio.

If your radio receives a scrambled call that is of a different Privacy Key, OR a different Key Value and Key ID, you will either hear a garbled transmission (Basic Privacy) or nothing at all (Enhanced Privacy).

The green LED lights up while the radio is transmitting and double blinks when the radio is receiving an ongoing privacy-enabled transmission.

NOTE: Some radio models may not offer this Privacy feature. Check with your dealer or system administrator for more information.



Procedure:



Press the programmed **Privacy** button to toggle privacy on or off.



OR



Follow the procedure below.

- 1  **OK** to access the menu.

 - 2  or  to Utilities and press  **OK** to select.

 - 3  or  to Radio Settings and press  **OK** to select.

 - 4  or  to Privacy.

 - 5 Press  **OK** to enable Privacy. The display shows ✓ beside Enabled.
- OR**
- Press  **OK** to disable Privacy. The ✓ disappears from beside Enabled.

If the radio has a privacy type assigned, the secure or unsecure icon appears on the status bar, except when the radio is sending or receiving an Emergency call or alarm.

■ Multi-Site Controls

These features are applicable when your current radio channel is part of an IP Site Connect or Linked Capacity Plus configuration.

See **IP Site Connect** on page 8 and **Linked Capacity Plus** on page 9 for more details about these configurations.

Starting an Automatic Site Search

NOTE: The radio **only** scans for a new site if the current signal is weak or when the radio is unable to detect any signal from the current site. If the RSSI value is strong, the radio remains on the current site.

Procedure:













Press the programmed **Site Lock On/Off** button.

- 1 A tone sounds and the display shows `Site Unlocked`.
- 2 The yellow LED blinks rapidly when the radio is actively searching for a new site, and turns off once the radio locks on to a site.
- 3 The display shows the channel alias and the site roaming icon appears.

OR

Procedure:

Use the menu.

- 1  to access the menu.
- 2  or  to Utilities and press  to select.
- 3  or  to Radio Settings and press  to select.
- 4  or  to Site Roaming and press  to select.
- 5  or  to Unlock Site and press  to select. A tone sounds and the display shows `Site Unlocked`.
- 6 The radio returns to the Home screen. The display shows the channel alias and the site roaming icon appears.
- 7 The yellow LED blinks rapidly when the radio is actively searching for a new site, and turns off once the radio locks on to a site.

*The radio also performs an automatic site search (site is unlocked) during a **PTT** button press or data transmission if the current channel, a multi-site channel with an attached roam list, is out of range.*

Stopping an Automatic Site Search

When the radio is actively searching for a new site:















Procedure:

Press the programmed **Site Lock On/Off** button.

- 1 A tone sounds and the display shows Site Locked.
- 2 The LED turns off and the display shows the channel alias.

OR**Procedure:**

Use the menu.

- 1  to access the menu.
 - 2  or  to Utilities and press  to select.
 - 3  or  to Radio Settings and press  to select.
 - 4  or  to Site Roaming and press  to select.
 - 5  or  to Lock Site State.
 - 6 Press  to lock site. The display shows ✓ beside Enabled.
- OR**
- Press  to unlock site. The ✓ disappears from beside Enabled.
- 7 The LED turns off and the radio returns to the Home screen. The display shows the channel alias.

Starting a Manual Site Search













Procedure:

Press the programmed **Manual Site Roam** button and proceed

to Step 6.

OR

Follow the procedure below.

- 1  to access the menu.
 - 2  or  to Utilities and press  to select.
 - 3  or  to Radio Settings and press  to select.
 - 4  or  to Site Roaming and press  to select.
 - 5  or  to Active Search and press  to select.
 - 6 A tone sounds and the display shows Finding Site. The green LED blinks.
 - 7 If a new site is found, a tone sounds and the LED turns off. The display shows Site <Alias> Found.
- OR**
- If there is no available site within range, a tone sounds and the LED turns off. The display shows Out of Range.
- OR**
- If a new site is within range, but the radio is unable to connect to it, a tone sounds and the LED turns off. The display shows Channel Busy.
- 8 The radio returns to the Home screen.

■ Security

You can enable or disable any radio in the system. For example, you might want to disable a stolen radio, to prevent the thief from using it, and enable that radio, when it is recovered.



NOTE: Performing Radio Disable and Enable is limited to radios with these functions enabled.

Radio Disable

Procedure:

Use the programmed **Radio Disable** button.

- 1 Press the programmed **Radio Disable** button.

- 2  or  to the required subscriber alias or ID and press  to select.

- 3 The display shows transitional mini notice, indicating the request is in progress. The green LED blinks.

- 4 Wait for acknowledgment.



- 5 If successful, a positive indicator tone sounds and the display shows positive mini notice.
OR
If unsuccessful, a negative indicator tone sounds and the display shows negative mini notice.



OR



Procedure:

Use the menu.

- 1  to access the menu.

- 2  or  to **Contacts** and press  to select. The entries are alphabetically sorted.

- 3  or  to the required subscriber alias or ID and press  to select.

- 4  or  to **Radio Disable** and press  to select.

- 5 The display shows transitional mini notice, indicating the request is in progress. The green LED blinks.

- 6 Wait for acknowledgment.

- 7 If successful, a positive indicator tone sounds and the display shows positive mini notice.
OR
If unsuccessful, a negative indicator tone sounds and the display shows negative mini notice.

Do not press  during the Radio Disable operation as you will not get an acknowledgement message.



*You can also access this feature using manual dial (see **Radio Disable via Manual Dial** on page 92).*

Radio Enable

Procedure:

Use the programmed **Radio Enable** button.

- 1 Press the programmed **Radio Enable** button.

- 2  or  to the required subscriber alias or ID and press  to select.

- 3 The display shows `Radio Enable` and the subscriber alias or ID. The green LED lights up.

- 4 Wait for acknowledgment.



- 5 If successful, the radio sounds a positive indicator tone and the display shows positive mini notice.
OR
If unsuccessful, the radio sounds a negative indicator tone and the display shows negative mini notice.



OR



Procedure:

Use the menu.

- 1  to access the menu.

- 2  or  to `Contacts` and press  to select. The entries are alphabetically sorted.

- 3  or  to the required subscriber alias or ID and press  to select.

- 4  or  to `Radio Enable` and press  to select. The green LED blinks.

- 5 The display shows `Radio Enable` and the subscriber alias or ID. The green LED lights up.

- 6 Wait for acknowledgment.

- 7 If successful, a tone sounds and the display shows `Radio Enable Successful`.
OR
If not successful, a tone sounds and the display shows `Radio Enable Failed`.

Do not press  during the Radio Enable operation as you will not get an acknowledgement message.

*You can also access this feature using manual dial (see **Radio Enable via Manual Dial** on page 92).*

■ Lone Worker

This feature prompts an emergency to be raised if there is no user activity, such as any radio button press or activation of the channel selector, for a predefined time.

Following no user activity for a programmed duration, the radio pre-warns the user via an audio indicator once the inactivity timer expires.

If there is still no acknowledgment by the user before the predefined reminder timer expires, the radio initiates an Emergency Alarm.

Only **one** of the following Emergency Alarms is assigned to this feature:

- Emergency Alarm
- Emergency Alarm with Call
- Emergency Alarm with Voice to Follow 

The radio remains in the emergency state allowing voice messages to proceed until action is taken. See **Emergency Operation** on page 43 on ways to exit Emergency.

NOTE: This feature is limited to radios with this function enabled. Check with your dealer or system administrator for more information.

NOTE:

■ Bluetooth

This feature allows you to use your radio with a Bluetooth-enabled device (accessory) via a Bluetooth connection. Your radio supports both Motorola and COTS (Commercially available Off-The-Shelf) Bluetooth-enabled devices.

Bluetooth operates within a range of 10 meters line of sight. This is an unobstructed path between your radio and your Bluetooth-enabled device.

It is not recommended that you leave your radio behind and expect your Bluetooth-enabled device to work with a high degree of reliability when they are separated.

At the fringe areas of reception, both voice and tone quality will start to sound "garbled" or "broken". To correct this problem, simply position your radio and Bluetooth-enabled device closer to each other (within the 10-meter defined range) to re-establish clear audio reception. Your radio's Bluetooth function has a maximum power of 2.5 mW (4 dBm) at the 10-meter range.



Your radio can support up to 3 simultaneous Bluetooth connections with Bluetooth-enabled devices of unique types. For example, a headset, a scanner, and a PTT-Only Device (POD). Multiple connections with Bluetooth-enabled devices of the same type are not supported.



Refer to your respective Bluetooth-enabled device's user manual for more details on your Bluetooth-enabled device's full capabilities.







Turning Bluetooth On or Off

Procedure:

- 1  to access the menu.

- 2  or  to Bluetooth and press  to select.

- 3  or  to My Status and press  to select.



- 4 The display shows On and Off.  or  to On and press  to enable Bluetooth. ✓ appears beside On. The Bluetooth icon appears on the status bar.
OR
 The display shows On and Off.  or  to Off and press  to disable Bluetooth. ✓ appears beside Off.



Finding and Connecting to a Bluetooth Device



Procedure:





- 1 Turn on your Bluetooth-enabled device and place it in pairing mode. Refer to respective Bluetooth-enabled device's user manual.



 - 2 On your radio, press  to access the menu.

 - 3  or  to Bluetooth and press  to select.

 - 4  or  to Devices and press  to select.

 - 5  or  to the required device and press  to select.
- OR**

 or  to Find Devices to locate available devices.
 or  to the required device and press  to select.

- 6  or  to Connect and press  to select. Display shows Connecting to <device>. Your Bluetooth-enabled device may require additional steps to complete the pairing. Refer to respective Bluetooth-enabled device's user manual.

- 7 If successful, the radio display shows <Device> Connected. A tone sounds and ✓ appears beside the connected device. The Bluetooth Connected icon appears on the status bar.
OR
 If unsuccessful, the radio display shows Connecting Failed.



Do not turn off your Bluetooth-enabled device or press  during the finding and connecting operation as this cancels the operation.



NOTE: If pin code is required, use the same entry method as Step 2 in **Accessing the Radio from Password** on page 93.



Disconnecting from a Bluetooth Device



Procedure:

- 1 On your radio, press  to access the menu.

- 2  or  to Bluetooth and press  to select.

- 3  or  to Devices and press  to select.

- 4  or  to the required device and press  to select.

- 5  or  to Disconnect and press  to select. Display shows Disconnecting from <device>. Your Bluetooth-enabled device may require additional steps to disconnect. Refer to respective Bluetooth-enabled device's user manual.

- 6 The radio display shows <Device> Disconnected. A positive indicator tone sounds and ✓ disappears beside the connected device. The Bluetooth Connected icon disappears on the status bar.

Switching Audio Route

You can toggle audio routing between internal radio speaker and external Bluetooth-enabled accessory.

Procedure:



- 1 Press the programmed **Bluetooth Audio Switch** button .



- 2 A tone sounds and display shows Route Audio to Radio.
OR
A tone sounds and display shows Route Audio to Bluetooth.



Viewing Device Details



Procedure:

- 1  to access the menu.

- 2  or  to Bluetooth and press  to select.

- 3  or  to Devices and press  to select.

- 4  or  to the required device and press  to select.

- 5  or  to View Details and press  to select.

■ Notification List

Your radio has a Notification List that collects all your “unread” events on the channel, such as unread text messages, telegrams, telemetry messages, missed calls, and call alerts.

The Notification icon appears on the status bar when the Notification List has one or more events.

The list supports a maximum of forty (40) unread events. When it is full, the next event automatically replaces the oldest event.



After the events are read, they are removed from the Notification List.



NOTE: Your radio suspends Scan when the Notification List is displayed. Scanning resumes when your radio exits the Notification List. Press  to exit the Notification List or wait for the menu timer to expire.

Accessing the Notification List

Procedure:

- 1  to access the menu.

- 2  or  to Notification and press  to select.

- 3  or  to the required event and press  to select.

Long press  to return to the Home screen.

■ Utilities

Turning the Radio Tones/Alerts On or Off

You can enable and disable all radio tones and alerts (except for the incoming Emergency alert tone) if needed.



Procedure:



Press the programmed **All Tones/Alerts** button to toggle all tones on or off.



OR



Follow the procedure below.



- 1  to access the menu.

 - 2  or  to Utilities and press  to select.

 - 3  or  to Radio Settings and press  to select.

 - 4  or  to Tones/Alerts and press  to select.

 - 5  or  to All Tones and press  to select.



 - 6 Press  to enable all tones. The display shows ✓ beside Enabled.
- OR**
- Press  to disable all tones. The ✓ disappears from beside Enabled.



Setting the Tone Alert Volume Offset Level



You can adjust the Tone Alert Volume Offset level if needed. This feature adjusts the volume of the tones/alerts, allowing it to be higher or lower than the voice volume.



Procedure:



- 1  to access the menu.



- 2  or  to Utilities and press  to select.

- 3  or  to Radio Settings and press  to select.

- 4  or  to Tones/Alerts and press  to select.

- 5  or  to Vol. Offset and press  to select.

- 6  or  to the required volume value. The radio sounds a feedback tone with each corresponding volume value.



- 7 Press  to keep the required displayed volume value.
OR
 Repeat Step 6 to select another volume value.
OR
 to exit without changing the current volume offset settings.



Turning the Talk Permit Tone On or Off



You can enable and disable the Talk Permit Tone if needed.



Procedure:



- 1  to access the menu.

- 2  or  to Utilities and press  to select.

- 3  or  to Radio Settings and press  to select.

- 4  or  to Tones/Alerts and press  to select.

- 5  or  to Talk Permit and press  to select.

- 6 Press  to enable Talk Permit Tone. The display shows ✓ beside Enabled.
OR
 Press  to disable Talk Permit Tone. The ✓ disappears from beside Enabled.

Setting the Power Level

You can customize your radio's power setting to high or low for each channel.

Settings: **High** enables communication with radios located at a considerable distance from you. **Low** enables communication with radios in closer proximity.



Procedure:



Press the programmed **Power Level** button to toggle transmit power level between high and low.



OR



Follow the procedure below.

- 1  to access the menu.

- 2  or  to Utilities and press  to select.

- 3  or  to Radio Settings and press  to select.

- 4  or  to Power and press  to select.

- 5  or  to the required setting and press  to select. ✓ appears beside selected setting.

- 6 Screen returns to the previous menu.

Long press  to return to the Home screen. The power level icon is visible.

Changing the Display Mode

You can change radio's display mode between Day or Night, as needed. This affects the colour palette of the display.



Procedure:



Press the programmed **Display Mode** button to toggle the display mode settings.



OR



Follow the procedure below.

- 1  to access the menu.

- 2  or  to Utilities and press  to select.

- 3  or  to Radio Settings and press  to select.

- 4  or  to Day/Night and press  to select.

- 5 The display shows Day Mode and Night Mode.  or  to the required setting and press  to enable. ✓ appears beside selected setting.

Adjusting the Display Brightness

You can adjust radio's display brightness as needed.



Procedure:



Press the programmed **Brightness** button and proceed to Step 5.



OR



Follow the procedure below.

- 1  to access the menu.

- 2  or  to Utilities and press  to select.

- 3  or  to Radio Settings and press  to select.

- 4  or  to Brightness and press  to select.

- 5 The display shows a progress bar. Decrease display brightness by pressing  or increase the display brightness by pressing . Press  to confirm your entry.

Turning Horns/Lights On or Off

Your radio is able to notify you of an incoming call via the horns and lights feature. When activated, an incoming call sounds your vehicle's horn and turns on its lights.

This feature needs to be installed through your radio's rear accessory connector by your dealer.



Procedure:



Press the programmed **Horns/Lights** button to toggle horns and lights feature on or off.



OR



Follow the procedure below.

- 1  to access the menu.

 - 2  or  to **Utilities** and press  to select.

 - 3  or  to **Radio Settings** and press  to select.

 - 4  or  to **Horns/Lights** and press  to select.

 - 5 Press  to enable Horns/Lights. The display shows ✓ beside Enabled.
- OR**
- Press  to disable Horns/Lights. The ✓ disappears from beside Enabled
-

Turning the Public Address System On or Off

You can enable and disable the radio's internal public address (PA) system.

Procedure:

Press the programmed **PA On/Off** button to toggle the feature on or off.

Turning the External Public Address System On or Off

You can enable or disable the audio routing between the connected public address (PA) loudspeaker amplifier and the radio's internal public address (PA) system.

Procedure:

Press the programmed **Ext PA On/Off** button to toggle the feature on or off.

Setting the Squelch Level

You can adjust your radio's squelch level to filter out unwanted calls with low signal strength or channels that have a higher than normal background noise.

Settings: **Normal** is the default. **Tight** filters out (unwanted) calls and/or background noise. However, calls from remote locations may also be filtered out.

Procedure:



Press the programmed **Squelch** button to toggle squelch level



between normal and tight.



OR



Follow the procedure below.

- 1  to access the menu.

- 2  or  to Utilities and press  to select.

- 3  or  to Radio Settings and press  to select.

- 4  or  to Squelch and press  to select.

- 5 The display shows Tight and Normal.  or  to the required setting and press  to enable. ✓ appears besides selected setting.



- 6 Screen returns to the previous menu.



Turning the Introduction Screen On or Off



You can enable and disable the Introduction Screen if needed.

Procedure:

- 1  to access the menu.

- 2  or  to Utilities and press  to select.

- 3  or  to Radio Settings and press  to select.

- 4  or  to Intro Screen and press  to select.

- 5 Press  to enable Introduction Screen. The display shows ✓ beside Enabled.

OR



Press  to disable Introduction Screen. The ✓ disappears from beside Enabled.



Turning the LED Indicators On or Off



You can enable and disable the LED Indicators if needed.

Procedure:

- 1  to access the menu.

- 2  or  to Utilities and press  to select.

- 3  or  to Radio Settings and press  to select.

- 4  or  to LED Indicator and press  to select.

- 5 Press  to enable LED indicator. The display shows ✓ beside Enabled.



OR



Press  to disable LED indicator. The ✓ disappears from beside Enabled.



Setting Dual Knob Operation Preference



Your radio has a dual-purpose **Volume/Channel Knob**. Disabling the dual-purpose option sets the knob to work as a Volume Knob only.

- 1  to access the menu.

- 2  or  to **Utilities** and press  to select.

- 3  or  to **Radio Settings** and press  to select.

- 4  or  to **Dual Knob** and press  to select.

- 5 The display shows **Volume Only** and **Volume & Ch.**
 or  to the required setting and press  to enable.
 ✓ appears besides selected setting.



- 6 Screen returns to the previous menu.



Language



You can set your radio display to be in your required language.

Procedure:

- 1  to access the menu.

- 2  or  to **Utilities** and press  to select.

- 3  or  to **Language** and press  to select.

- 4  or  to the required language and press  to enable. ✓ appears beside selected language.

Turning the Voice Operating Transmission (VOX) Feature On or Off

This feature allows you to initiate a hands-free voice activated call on a programmed channel. The radio automatically transmits, for a programmed period, whenever the microphone on the VOX-capable accessory detects voice.

NOTE: You may need to turn off the radio and power it up again after detaching the VOX-capable microphone from it to allow the radio to switch to another valid accessory.

Pressing the **PTT** button during radio operation disables VOX. To re-enable VOX, do **one** of the following:

- Turn the radio off and power it on again, **OR**
- Change the channel via the **Scroll Up/Down** buttons, **OR**
- Change the channel via the **Volume/Channel Knob**, **OR**
- Follow the procedure below.

NOTE: Turning this feature on or off is limited to radios with this function enabled. Check with your dealer or system administrator for more information.



Procedure:



Press the programmed **VOX** button to toggle the feature on or off.



OR

Follow the procedure below.

- 1  **OK** to access the menu.

- 2  or  to Utilities and press  **OK** to select.

- 3  or  to Radio Settings and press  **OK** to select.

- 4  or  to VOX and press  **OK** to select.

- 5 Press  **OK** to enable VOX. The display shows ✓ beside Enabled.

OR

Press  **OK** to disable VOX. The ✓ disappears from beside Enabled.

*If the Talk Permit Tone feature is enabled (see **Turning the Talk Permit Tone On or Off** on page 68), use a trigger word to initiate the call. Wait for the Talk Permit Tone to finish before speaking clearly into the microphone.*

Turning the Option Board Feature(s) On or Off

Option board capabilities within each channel and can be assigned to programmable buttons. Refer to your dealer or system administrator for more information.

Procedure:



Press the programmed **Option Board Feature** button to toggle the feature on or off.



Identifying Cable Type



You can select the type of cable your radio uses.

Procedure:

- 1  **OK** to access the menu.

- 2  or  to Utilities and press  **OK** to select.

- 3  or  to Radio Settings and press  **OK** to select.

- 4  or  to Cable Type and press  **OK** to select.

- 5 The current cable type is indicated by a ✓.

Voice Announcement

This feature enables the radio to audibly indicate the current Zone or Channel the user has just assigned, or programmable button press. This audio indicator can be customized per customer requirements. This is typically useful when the user is in a difficult condition to read the content shown on the display.







Use the following features to toggle Voice Announcement on or off.

Procedure:

Press the programmed **Voice Announcement** button.

OR

Follow the procedure below.

- 1  to access the menu.
- 2  or  to Utilities and press  to select.
- 3  or  to Voice Announcement.
- 4 Press  to enable Voice Announcement. The display shows ✓ beside Enabled.







OR

Press  to disable Voice Announcement. The ✓ disappears from beside Enabled.

Call Forwarding

You can enable your radio to automatically forward voice calls to another radio.

Procedure:

- 1  to access the menu.
- 2  or  to Utilities and press  to select.
- 3  or  to Call Forward.
- 4 Press  to enable Call Forwarding. The display shows ✓ beside Enabled.













OR

Press  to disable Call Forwarding. The ✓ disappears from beside Enabled.

Menu Timer

Set the period of time your radio stays in the menu before it automatically switches to the Home screen.





Procedure:



- 1  to access the menu.
- 2  or  to Utilities and press  to select.
- 3  or  to Radio Settings and press  to select.
- 4  or  to Menu Timer and press  to select.
- 5  or  to the required setting and press  to enable.



Analog Mic AGC



This feature controls the your radio's microphone gain automatically while transmitting on an analog system. It suppresses loud audio or boosts soft audio to a preset value in order to provide a consistent level of audio.

Procedure:

- 1  to access the menu.
- 2  or  to Utilities and press  to select.

- 3  or  to Radio Settings and press  to select.

- 4  or  to Analog Mic AGC.



- 5 Press  to enable Analog Mic AGC. The display shows ✓ beside Enabled.
OR
 Press  to disable Analog Mic AGC. The ✓ disappears from beside Enabled.



Digital Mic AGC



This feature controls the your radio's microphone gain automatically while transmitting on an digital system. It suppresses loud audio or boosts soft audio to a preset value in order to provide a consistent level of audio.



Procedure:

- 1  to access the menu.

- 2  or  to Utilities and press  to select.

- 3  or  to Radio Settings and press  to select.

- 4  or  to Digital Mic AGC.

- 5 Press  to enable Digital Mic AGC. The display shows ✓ beside Enabled.
OR
 Press  to disable Digital Mic AGC. The ✓ disappears from beside Enabled.

Intelligent Audio

Your radio automatically adjusts its audio volume to overcome current background noise in the environment, inclusive of both stationary and non-stationary noise sources. This feature is a Receive-only feature and does not affect Transmit audio.

NOTE: *This feature is not applicable during a Bluetooth session.*

Use the following features to toggle Intelligent Audio on or off.



Procedure:



Press the programmed **Intelligent Audio** button to toggle the feature on or off.



OR



Follow the procedure below.

- 1  to access the menu.

- 2  or  to Utilities and press  to select.

- 3  or  to Radio Settings and press  to select.

- 4  or  to Intelligent Audio.

- 5 Press  to enable Intelligent Audio. The display shows ✓ beside Enabled.
OR
 Press  to disable Intelligent Audio. The ✓ disappears from beside Enabled.

GPS



Global Positioning System (GPS) is a satellite navigation system that determines the radio's precise location.



Procedure:



Press the programmed **GPS** button to toggle the feature on or off.



OR

- 1  to access the menu.

 - 2  or  to Utilities and press  to select.

 - 3  or  to Radio Settings and press  to select.

 - 4  or  to GPS.



 - 5 Press  to enable GPS. The display shows ✓ beside Enabled.
- OR**
- Press  to disable GPS. The ✓ disappears from beside Enabled.

See **Checking the GPS Information** on page 77 for details on retrieving GPS information.

Accessing General Radio Information

Your radio contains information on the following:

- Radio Alias and ID 
- Firmware and Codeplug Versions
- GPS Information

NOTE: Press  at any time to return to the previous screen or long press  to return to the Home screen. The radio exits the current screen once the inactivity timer expires.

Checking the Radio Alias and ID

Displays the ID of your radio.



Procedure:



Press the programmed Radio Alias and ID button to check your radio alias and ID. You hear a positive indicator tone.



OR

Follow the procedure below.

- 1  to access the menu.

- 2  or  to Utilities and press  to select.

- 3  or  to Radio Info and press  to select.

- 4  or  to My Number and press  to select.

- 5 The first line of the display shows the radio alias. The second line of the display shows the radio ID.
-



You can also press the programmed **Radio Alias and ID** button to return to the previous screen.



Checking the Firmware Version and Codeplug Version



Displays the firmware and codeplug versions on your radio.

Procedure:

- 1  to access the menu.

- 2  or  to Utilities and press  to select.

- 3  or  to Radio Info and press  to select.

- 4  or  to Versions and press  to select.

The display shows the current firmware and codeplug versions.



Checking the GPS Information



Displays the GPS information on your radio, such as values of:



- Latitude
- Longitude
- Altitude
- Direction
- Velocity
- Horizontal Dilution of Precision (HDOP)
- Satellites
- Version



Procedure:

- 1  to access the menu.

- 2  or  to Utilities and press  to select.

- 3  or  to Radio Info and press  to select.

- 4  or  to GPS Info and press  to select.

- 5  or  to the required item and press  to select.

- 6 The display shows the requested GPS information.

See **GPS** on page 76 for details on GPS.

■ Keypad Microphone Features

The following additional features for your radio are available with a keypad-enabled microphone:

- Using the Keypad page 79
- Additional Advanced Features page 80
- Text Messaging page 87
- Dual Tone Multi Frequency (DTMF) page 91
- Security page 92
- Password Lock Features. page 93
- Front Panel Programming (FPP). page 95

■ Using the Keypad

You can use the 3 x 4 alphanumeric keypad on the 4-Way Navigation Keypad Microphone (Motorola part number RMN5127_) to access your radio's features. You can use the keypad to enter subscriber aliases or IDs, and text messages. Many characters require that you press a key multiple times. The table below shows the number of times a key needs to be pressed to generate the required character.



Key	Number of Times Key is Pressed												
	1	2	3	4	5	6	7	8	9	10	11	12	13
1	1	.	,	?	!	@	&	'	%	-	:	*	#
2	A	B	C	2									
DEF 3	D	E	F	3									
4	G	H	I	4									
5	J	K	L	5									
MNO 6	M	N	O	6									
7	P	Q	R	S	7								
8	T	U	V	8									
WXYZ 9	W	X	Y	Z	9								
0	0	NOTE: Press to enter "0" and long press to activate the CAPS lock. Another long press to turn off the CAPS lock.											
* <	* or del	NOTE: Press during text entry to delete the character. Press during numeric entry to enter a "**".											
#	# or space	NOTE: Press during text entry to insert a space. Press during numeric entry to enter a "#".											



☞ Turning Keypad Tones On or Off



You can enable and disable Keypad Tones if needed.



Procedure:



- 1  to access the menu.

- 2  or  to Utilities and press  to select.

- 3  or  to Radio Settings and press  to select.

- 4  or  to Tones/Alerts and press  to select.

- 5  or  to Keypad Tones and press  to select.



- 6 Press  to enable keypad tones. The display shows ✓ beside Enabled.
OR
 Press  to disable keypad tones. The ✓ disappears from beside Enabled.

■ Additional Advanced Features



☞ Selecting a Zone by Alias Search



Procedure:

- 1  to access the menu.

- 2  or  to Zone and press  to select.

- 3 The current zone is displayed and indicated by a ✓.

- 4  or  to the required zone and proceed to Step 7.
OR
 Key in the first character of the required zone.

- 5 A blinking cursor appears.
 Use the keypad to type the required zone.
 Press  to move one space to the left.
 Press  to move one space to the right.
 Press the *DEL key to delete any unwanted characters.













- 6 The first line of the display shows the characters you keyed in. The next lines of the display show the shortlisted search results.
 The alias search is case-insensitive. If there are two or more zones with the same name, the radio displays the zone that is listed first in the zone list.

- 7 Press  to select.

- 8 The display shows <Zone> Selected momentarily and returns to the selected zone screen.

Initiating a Radio Check by Manual Dial

Procedure:













- 1  to access the menu.
- 2  or  to Contacts and press  to select.
- 3  or  to Manual Dial and press  to select.
- 4 If there was previously dialed ID, the ID appears along with a blinking cursor. Use the keypad to edit the ID. Press  to select.
OR
Key in the subscriber alias or ID and press .
- 5  or  to Radio Check and press  to select.
- 6 The display shows transitional mini notice, indicating the request is in progress. The green LED lights up.
- 7 Wait for acknowledgement.
- 8 If successful, a positive indicator tone sounds and the display shows positive mini notice.
OR
If unsuccessful, a negative indicator tone sounds and the display shows negative mini notice.

- 9 Radio returns to the subscriber alias or ID screen.

If the  button is pressed when the radio is waiting for acknowledgement, a tone sounds, and the radio terminates all retries and exits Radio Check mode.

Initiating Remote Monitor by Manual Dial

Procedure:

- 1  to access the menu.
- 2  or  to Contacts and press  to select.
- 3  or  to Manual Dial and press  to select.
- 4 If there was previously dialed ID, the ID appears along with a blinking cursor. Use the keypad to edit the ID. Press  to select.
OR
Key in the subscriber alias or ID and press .
- 5  or  to Remote Mon. and press  to select.
- 6 The display shows transitional mini notice, indicating the request is in progress. The green LED lights up.
- 7 Wait for acknowledgment.
- 8 If successful, a positive indicator tone sounds and the display shows positive mini notice. Your radio starts playing audio from the monitored radio for a programmed duration and display shows Rem. Monitor.







Once the timer expires, the radio sounds an alert tone and the LED turns off.

OR

If unsuccessful, the radio sounds a negative indicator tone the display shows negative mini notice.

Making a Private Call by Manual Dial

Procedure:

- 1  to access the menu.
 - 2  or  to **Contacts** and press  to select. The entries are alphabetically sorted.
 - 3  or  to **Manual Dial** and press  to select.
 - 4 If there is a previously dialed subscriber ID, the ID appears along with a blinking cursor.
Use the keypad to edit the subscriber ID.
OR
Use the keypad to enter a new subscriber ID.
 - 5 Press the **PTT** button to make the call. The green LED lights up. The display shows the destination alias.
 - 6 Wait for the Talk Permit Tone to finish (if enabled) and speak clearly into the microphone.
 - 7 Release the **PTT** button to listen. When the target radio responds, the green LED blinks.
-

- 8 If the Channel Free Indication feature is enabled, you hear a short alert tone the moment the target radio releases the **PTT** button, indicating the channel is free for you to respond. Press the **PTT** button to respond.

OR

If there is no voice activity for a programmed period of time, the call ends.

- 9 You hear a short tone. The display shows **Call Ended**.
-

Making a Group, Private or All Call with the Programmable Number Key

The Programmable Number Key feature allows you to make a Group, Private or All Call to a predefined alias or ID easily. This feature can be assigned to all the available number keys on a keypad microphone.

You can **ONLY** have one alias or ID assigned to a number key, but you can have more than one number key associated to an alias or ID.

Procedure:

When you are on the Home screen:

- 1 Long press the programmed number key to make a Group, Private or All Call to the predefined alias or ID.
If the number key is not associated to an entry, a negative indicator tone sounds.
-

- 2 Press the **PTT** button to make the call. The green LED lights up. The Group/Private Call icon appears in the top right corner. The first text line shows the caller alias. The second text line displays either the call status for a Private Call or **All Call** for All Call.

- 3 Wait for the Talk Permit Tone to finish (if enabled) and speak clearly into the microphone.
OR
 **For Group Call only:** Wait for the **PTT** Sidetone to finish (if enabled) and speak clearly into the microphone.

- 4 Release the **PTT** button to listen. When the target radio responds, the green LED blinks. The display shows the destination alias.

- 5 If the Channel Free Indication feature is enabled, you hear a short alert tone the moment the target radio releases the **PTT** button, indicating the channel is free for you to respond. Press the **PTT** button to respond.
OR
If there is no voice activity for a predetermined period of time, the call ends.

- 6 Radio returns to the screen you were on prior to initiating the call.

For a Private Call, you hear a short tone when the call ends.

See **Assigning an Entry to a Programmable Number Key** on page 35 for details on assigning an entry to a number key on the keypad.



Making a Group, Private, Phone or All Call by Alias Search

You can also use alias or alphanumeric search to retrieve the required subscriber alias.



This feature is only applicable while in Contacts.

Procedure:

- 1  to access the menu.



- 2  or  to **Contacts** and press  to select. The entries are alphabetically sorted.

- 3 Key in the first character of the required alias.

- 4 A blinking cursor appears.
Use the keypad to type the required alias.
Press  to move one space to the left.
Press  to move one space to the right.
Press the *DEL key to delete any unwanted characters.







- 5 The first line of the display shows the characters you keyed in. The next lines of the display show the shortlisted search results.
The alias search is case-insensitive. If there are two or more aliases with the same name, the radio displays the alias that is listed first in the Contacts list.



- 6 Press the **PTT** button to make the call. The green LED lights up. The first line displays the target radio's ID.
- 7 Wait for the Talk Permit Tone to finish (if enabled) and speak clearly into the microphone
- 8 Release the **PTT** button to listen. When the target radio responds, the green LED blinks. The display shows the destination alias.
- 9 If the Channel Free Indication feature is enabled, you hear a short alert tone the moment the target radio releases the **PTT** button, indicating the channel is free for you to respond. Press the **PTT** button to respond.
OR
If there is no voice activity for a programmed period of time, the call ends.
- 10 You hear a short tone. The display shows `Call Ended`.

NOTE: Press  button or  to exit alias search.

Viewing an Entry in the Scan List by Alias Search

Procedure:

- 1  to access the menu.
- 2  or  to `Scan` and press  to select.
- 3  or  to `Scan List` and press  to select.
- 4 Key in the first character of the required alias.











- 5 A blinking cursor appears.
Use the keypad to type the required alias.
Press  to move one space to the left.
Press  to move one space to the right.
Press the ***DEL** key to delete any unwanted characters.
- 6 The first line of the display shows the characters you keyed in. The next lines of the display show the shortlisted search results.

The alias search is case-insensitive. If there are two or more entries with the same name, the radio displays the entry that is listed first in the scan list.

Editing the Scan List by Alias Search

Adding a New Entry to the Scan List











Procedure:

- 1  to access the menu.
- 2  or  to `Scan` and press  to select.
- 3  or  to `Scan List` and press  to select.
- 4  or  to `Add Member` and press  to select.
- 5 Key in the first character of the required alias.
- 6 A blinking cursor appears.
Use the keypad to type the required alias.

Press  to move one space to the left.

Press  to move one space to the right.



















Press the *DEL key to delete any unwanted characters.

- 7 The first line of the display shows the characters you keyed in. The next lines of the display show the shortlisted search results.
The alias search is case-insensitive. If there are two or more aliases with the same name, the radio displays the alias that is listed first in the list.
- 8 Press  to select.
- 9  or  to the required priority level and press  to select.
- 10 The display shows positive mini notice, followed immediately by Add Another?.
- 11  or  to Yes and press  to select, to add another entry, and repeat Steps 5 to 9.
OR
 or  to No and press  to select to save the current list.

Deleting an Entry from the Scan List

Procedure:













- 1  to access the menu.



- 2  or  to Scan and press  to select.
- 3  or  to Scan List and press  to select.
- 4 Key in the first character of the required alias.
- 5 A blinking cursor appears.
Use the keypad to type the required alias.
Press  to move one space to the left.
Press  to move one space to the right.
Press the *DEL key to delete any unwanted characters.
- 6 The first line of the display shows the characters you keyed in. The next lines of the display show the shortlisted search results.
The alias search is case-insensitive. If there are two or more entries with the same name, the radio displays the entry that is listed first in the scan list.
- 7 Press  to select.
- 8  or  to Delete and press  to select.
- 9 At Delete Entry?,  or  to Yes and press  to select, to delete the entry. The display shows positive mini notice.
OR
 or  to No and press  to select to return to the previous screen.
- 10 Repeat Steps 4 to 9 to delete other entries.

After deleting all required aliases or IDs, long press  to return to the Home screen.

Setting and Editing Priority for an Entry in the Scan List

Procedure:

- 1  to access the menu.
- 2  or  to Scan and press  to select.
- 3  or  to Scan List and press  to select.
- 4 Key in the first character of the required alias.
- 5 A blinking cursor appears.
Use the keypad to type the required alias.
Press  to move one space to the left.
Press  to move one space to the right.
Press the *DEL key to delete any unwanted characters.
- 6 The first line of the display shows the characters you keyed in. The next lines of the display show the shortlisted search results.
The alias search is case-insensitive. If there are two or more entries with the same name, the radio displays the entry that is listed first in the scan list.
- 7 Press  to select.
- 8  or  to Edit Priority and press  to select.

9  or  to the required priority level and press  to select.















10 The display shows positive mini notice before returning to the previous screen.

11 The priority icon appears left of the member's name.

*There is no priority icon if priority is set to **None**.*

Storing an Alias or ID from a Call List

Procedure:



- 1  to access the menu.
- 2  or  to Call Log and press  to select.
- 3  or  to the required list and press  to select.
- 4  or  to the required alias or ID and press  to select.
- 5  or  to Store and press  to select.
- 6 A blinking cursor appears. If needed, key in the alias for that ID and press .
- 7 The display shows positive mini notice.



You can also store an ID without an alias.

Making a Call Alert by Manual Dial



Procedure:

- 1  to access the menu.

- 2  or  to **Contacts** and press  to select.

- 3  or  to **Manual Dial** and press  to select.

- 4 A blinking cursor appears. Enter the subscriber ID you want to send the Call Alert to and press .

- 5  or  to **Call Alert** and press  to select.

- 6 The display shows **Call Alert** and the subscriber alias or ID, indicating that the Call Alert has been sent.

- 7 The green LED lights up when your radio is sending the Call Alert.

- 8 If the Call Alert acknowledgement is received, the display shows positive mini notice.

OR

If the Call Alert acknowledgement is not received, the display shows negative mini notice.

Text Messaging

The **maximum** length of characters for a text message, including the subject line (seen when receiving message from an e-mail application), is **140**, whereas to receive would be a maximum of **280** characters.

The radio exits the current screen once the inactivity timer expires. Any text message in the writing/editing screen is automatically saved to the Drafts folder.

NOTE: Long press  at any time to return to the Home screen.

Writing and Sending a Text Message



Procedure:



Press the programmed **Text Message** button and proceed to Step 3.

OR

Follow the procedure below.

- 1  to access the menu.

- 2  or  to **Messages** and press  to select.

- 3  or  to **Compose** and press  to select.

- 4 Use the keypad to type your message.
Press  to move one space to the left.

Press **▶** or the # key to move one space to the right.
 Press the * key to delete any unwanted characters.

- 5 Press **[OK]** once message is composed.
- 6 **▲** or **▼** to the required alias or ID and press **[OK]** to select.
OR
▲ or **▼** to Manual Dial and press **[OK]** to select.
 Key in the subscriber ID and press **[OK]**.
OR
↶ to edit the message.
↶ again to discard the message or save it to the Drafts folder.
- 7 The display shows transitional mini notice, confirming your message is being sent.
- 8 If the message is sent, a tone sounds and the display shows positive mini notice.
OR
 If the message is not sent, a low tone sounds and the display shows negative mini notice.

*If the text message fails to send, the radio returns you to the Resend option screen (see **Managing Fail-to-Send Text Messages** on page 50 and page 90).*

Replying to Text Messages from the Inbox

Procedure:

Press the programmed **Text Message** button and proceed to Step 3.

OR

Follow the procedure below.

- 1 **[OK]** to access the menu.
- 2 **▲** or **▼** to Messages and press **[OK]** to select.
- 3 **▲** or **▼** to Inbox and press **[OK]** to select.
- 4 **▲** or **▼** to the required message and press **[OK]** to select.
 A subject line may be shown if the message is from an e-mail application.
- 5 Press **[OK]** once more to access additional options.
- 6 **▲** or **▼** to Reply and press **[OK]** to select.
 A blinking cursor appears. Use the keypad to type your message.
 Press **◀** to move one space to the left.
 Press **▶** or the # key to move one space to the right.
 Press the * key to delete any unwanted characters.
- 7 Press **[OK]** once message is composed.
- 8 The display shows transitional mini notice, confirming your message is being sent.

- 9 If the message is sent, a tone sounds and the display shows positive mini notice.

OR

If the message is not sent, a low tone sounds and the display shows negative mini notice.

*If the text message fails to send, the radio returns you to the Resend option screen (see **Managing Fail-to-Send Text Messages** on page 50 and page 90).*

NOTE: If a subject line is present (for messages received from an e-mail application), you cannot edit it.

Editing a Quick Reply Message



Procedure:



Press the programmed **Text Message** button and proceed to Step 3.



OR

Follow the procedure below.

- 1  to access the menu.

- 2  or  to Messages and press  to select.

- 3  or  to Quick Reply and press  to select.

- 4  or  to the required Quick Text and press  to select.

- 5 A blinking cursor appears. Use the keypad to edit the message.

Press  to move one space to the left.

Press  or the # key to move one space to the right.

Press the * key to delete any unwanted characters.

- 6 Press  once message is composed.

 - 7 The display shows transitional mini notice, confirming your message is being sent.

 - 8 If the message is sent, a tone sounds and the display shows positive mini notice.
- OR**
- If the message is not sent, a low tone sounds and the display shows negative mini notice.

*If the text message fails to send, the radio returns you to the Resend option screen (see **Managing Fail-to-Send Text Messages** on page 50 and page 90).*

Accessing the Drafts Folder

You can save a text message to send it at a later time.

If a **PTT** button press or a mode change causes the radio to exit the text message writing/editing screen while you are in the process of writing or editing a text message, your current text message is automatically saved to the Drafts folder.







The most recent saved text message is always added to the top of the Drafts list. See **Managing Text Messages in the Drafts Folder** on page 49 for more information.







NOTE: Long press  at any time to return to the Home screen.

Editing and Sending a Saved Text Message

Procedure:

- 1 Press  again while viewing the message.

- 2  or  to Edit and press  to select.
A blinking cursor appears.
Use the keypad to edit your message.
Press  to move one space to the left.
Press  or the # key to move one space to the right.
Press the *DEL key to delete any unwanted characters.
Press  once message is composed.

- 3  or  to the required alias or ID and press  to select.
OR
 or  to Manual Dial and press  to select.
Key in the subscriber alias or ID and press .

- 4 The display shows transitional mini notice, confirming your message is being sent.

- 5 If the message is sent, a tone sounds and the display shows positive mini notice.
OR
If the message is not sent, a low tone sounds and the display shows negative mini notice.

If the text message fails to send, it is moved to the Sent Items folder and marked with a Send Failed icon.



Managing Fail-to-Send Text Messages





if the message fails to send, the radio returns you to the Resend option screen.

Forwarding a Text Message by Manual Dial

Select Forward to send the message to another subscriber/group alias or ID.

Procedure:

- 1  or  to Forward and press  to select.

- 2  or  to Manual Dial and press  to select.
Key in the subscriber ID and press .

- 3 The display shows transitional mini notice, confirming your message is being sent.



- 4 If the message is sent, a tone sounds and the display shows positive mini notice.
OR
If the message is not sent, a low tone sounds and the display shows negative mini notice.



Editing a Text Message

Select **Edit** to edit the message before sending it.







NOTE: If a subject line is present (for messages received from an e-mail application), you cannot edit it.

Procedure:

- 1  or  to **Edit**, and press  to select.

- 2 A blinking cursor appears beside the message.
Use the keypad to edit your message.
Press  to move one space to the left.
Press  or the # key to move one space to the right.
Press the *DEL key to delete any unwanted characters.

- 3 Press  once message is composed.

- 4  or  to the required alias or ID and press  to select.
OR
 or  to **Manual Dial** and press  to select.
Key in the subscriber ID and press .

- 5 The display shows transitional mini notice, confirming your message is being sent.

- 6 If the message is sent, a tone sounds and the display shows positive mini notice.

OR

If the message is not sent, a low tone sounds and the display shows negative mini notice.

■ Dual Tone Multi Frequency (DTMF)

The Dual Tone Multi Frequency (DTMF) feature allows the radio to operate in a radio system with an interface to telephone systems.

Procedure:

To initiate a DTMF call.

- 1 Press and hold the **PTT** button.

- 2 Enter the desired number, * or #.



*You can turn off the DTMF tone by disabling all radio tones and alerts (see **Turning the Radio Tones/Alerts On or Off** on page 67).*





■ Security



Radio Disable via Manual Dial

Procedure:

- 1  to access the menu.

- 2  or  to **Contacts** and press  to select. The entries are alphabetically sorted.

- 3  or  to **Manual Dial** and press  to select. Key in the subscriber ID and press .

- 4  or  to **Radio Disable** and press  to select.

- 5 The display shows transitional mini notice, indicating the request is in progress. The green LED blinks.

- 6 Wait for acknowledgment.



- 7 If successful, a positive indicator tone sounds and the display shows positive mini notice.
OR
If unsuccessful, a negative indicator tone sounds and the display shows negative mini notice.





Do not press  during the Radio Disable operation as you will not get an acknowledgement message.



Radio Enable via Manual Dial

Procedure:

- 1  to access the menu.

- 2  or  to **Contacts** and press  to select. The entries are alphabetically sorted.

- 3  or  to **Manual Dial** and press  to select. Key in the subscriber ID and press .

- 4  or  to **Radio Enable** and press  to select.

- 5 The display shows **Radio Enable** and the subscriber alias or ID. The LED lights up solid green.

- 6 Wait for acknowledgment.

- 7 If successful, the radio sounds a positive indicator tone and the display shows positive mini notice.
OR
If unsuccessful, the radio sounds a negative indicator tone and the display shows negative mini notice.

Do not press  during the Radio Enable operation as you will not get an acknowledgement message.

■ Password Lock Features

If enabled, this feature allows you to access your radio via password upon powering up. You can use a keypad microphone or **Scroll Up/Down** buttons to enter password.

📄 Accessing the Radio from Password





Procedure:

Power up the radio.



- 1 You hear a continuous tone.
- 2 Enter your current four-digit password via keypad microphone.

The display shows ●●●●. Press  to proceed.

OR

Enter your current four-digit password. Press  or  to edit each digit's numeric value and  to enter the selected digit and move to the next digit. Each digit changes to ●. Press  to confirm your selection.

You hear a positive indicator tone for every digit pressed.

Press  to remove the each ● on the display. You hear a negative indicator tone, if you press  when the line is empty, or if you press more than four digits.

- 3 If the password is correct:
Your radio proceeds to power up. See **Powering Up the Radio** on page 2.

OR

If the password is incorrect:

The display shows Wrong Password. Repeat Step 2.

OR

After the third incorrect password, the display shows Wrong Password and then, shows Radio Locked. A tone sounds and the yellow LED double blinks.

*Your radio enters into locked state for 15 minutes, and responds to inputs from **On/Off** button and programmed **Backlight Auto** button only.*

NOTE: The radio is unable to receive any call, including emergency calls, in locked state.

The use of **Emergency** footswitch cancels out password input to access the radio.

📄 Unlocking the Radio from Locked State

Procedure:

Wait for 15 minutes. Repeat Steps 1 to 3 in **Accessing the Radio from Password** on page 93.

OR











Power up the radio, if you have powered down the radio during locked state:





- 1 A tone sounds and the yellow LED double blinks. The display shows **Radio Locked**.
- 2 Wait for 15 minutes. Repeat **Accessing the Radio from Password** on page 93.

Your radio restarts the 15 minutes timer for locked state when you power up.

📄 Turning the Password Lock On or Off













Procedure:

- 1  to access the menu.
- 2  or  to **Utilities** and press  to select.
- 3  or  to **Radio Settings** and press  to select.
- 4  or  to **Password Lock** and press  to select.
- 5 Enter a four-digit password.
See Step 2 in **Accessing the Radio from Password** on page 93.

- 6 If the password is correct:
Press  to enable Password Lock. The display shows  beside **Enabled**.
OR
Press  to disable Password Lock. The  disappears from beside **Enabled**.
OR
If the password is incorrect:
The display shows **Wrong Password** and automatically returns to the previous menu.

📄 Changing the Password

Procedure:

- 1  to access the menu.
- 2  or  to **Utilities** and press  to select.
- 3  or  to **Radio Settings** and press  to select.
- 4  or  to **Password Lock** and press  to select.
- 5 Enter your current four-digit password via keypad microphone.
See Step 2 in **Accessing the Radio from Password** on page 93.
- 6 If the password is correct:
 or  to **Change Pwd** and press  to select.
OR
If the password is incorrect:

The display shows *Wrong Password* and automatically returns to the previous menu.







- 7 Enter a new four-digit password via keypad microphone. See Step 2 in ***Accessing the Radio from Password*** on page 93.
- 8 Re-enter the new four-digit password. See Step 2 in ***Accessing the Radio from Password*** on page 93.
- 9 If both of the new password inputs match:
The display shows *Password Changed*.
OR
If both of the new password inputs do not match:
The display shows *Passwords Do Not Match*.
- 10 The screen automatically returns to the previous menu.

■ Front Panel Programming (FPP)

Your radio is able to customize certain feature parameters to enhance the use of your radio.

📖 Entering FPP Mode





Procedure:

- 1  to access the menu.
- 2  or  to *Utilities* and press  to select.
- 3  or  to *Program Radio* and press  to select.

NOTE: Long press  at any time to return to the Home screen.

📖 Editing FPP Mode Parameters

Use the following buttons as required while navigating through the feature parameters.

, , ,  – Scroll through options, increase/decrease values, or navigate vertically

 – Select the option or enter a sub-menu

 – Short-press to return to previous menu or to exit the selection screen. Long-press to return to Home screen.

Limited Warranty

MOTOROLA COMMUNICATION PRODUCTS

I. WHAT THIS WARRANTY COVERS AND FOR HOW LONG:

MOTOROLA SOLUTIONS INC. ("MOTOROLA") warrants the MOTOROLA manufactured Communication Products listed below ("Product") against defects in material and workmanship under normal use and service for a period of time from the date of purchase as scheduled below:

DM Series Digital Mobile Radios	Two (2) Years
Product Accessories	One (1) Year

MOTOROLA, at its option, will at no charge either repair the Product (with new or reconditioned parts), replace it (with a new or reconditioned Product), or refund the purchase price of the Product during the warranty period provided it is returned in accordance with the terms of this warranty. Replaced parts or boards are warranted for the balance of the original applicable warranty period. All replaced parts of Product shall become the property of MOTOROLA.

This express limited warranty is extended by MOTOROLA to the original end user purchaser only and is not assignable or transferable to any other party. This is the complete warranty for the Product manufactured by MOTOROLA. MOTOROLA assumes no

obligations or liability for additions or modifications to this warranty unless made in writing and signed by an officer of MOTOROLA.

Unless made in a separate agreement between MOTOROLA and the original end user purchaser, MOTOROLA does not warrant the installation, maintenance or service of the Product.

MOTOROLA cannot be responsible in any way for any ancillary equipment not furnished by MOTOROLA which is attached to or used in connection with the Product, or for operation of the Product with any ancillary equipment, and all such equipment is expressly excluded from this warranty. Because each system which may use the Product is unique, MOTOROLA disclaims liability for range, coverage, or operation of the system as a whole under this warranty.

II. GENERAL PROVISIONS:

This warranty sets forth the full extent of MOTOROLA'S responsibilities regarding the Product. Repair, replacement or refund of the purchase price, at MOTOROLA'S option, is the exclusive remedy. THIS WARRANTY IS GIVEN IN LIEU OF ALL OTHER EXPRESS WARRANTIES. IMPLIED WARRANTIES, INCLUDING WITHOUT LIMITATION, IMPLIED WARRANTIES OF MERCHANTABILITY AND FITNESS FOR A PARTICULAR PURPOSE, ARE LIMITED TO THE DURATION OF THIS LIMITED WARRANTY. IN NO EVENT SHALL MOTOROLA BE LIABLE FOR DAMAGES IN EXCESS OF THE PURCHASE PRICE OF THE PRODUCT, FOR ANY LOSS OF USE, LOSS OF TIME, INCONVENIENCE, COMMERCIAL LOSS, LOST PROFITS OR SAVINGS OR OTHER INCIDENTAL, SPECIAL OR CONSEQUENTIAL DAMAGES ARISING OUT OF THE USE OR

INABILITY TO USE SUCH PRODUCT, TO THE FULL EXTENT SUCH MAY BE DISCLAIMED BY LAW.

III. STATE LAW RIGHTS:

SOME STATES DO NOT ALLOW THE EXCLUSION OR LIMITATION OF INCIDENTAL OR CONSEQUENTIAL DAMAGES OR LIMITATION ON HOW LONG AN IMPLIED WARRANTY LASTS, SO THE ABOVE LIMITATION OR EXCLUSIONS MAY NOT APPLY.

This warranty gives specific legal rights, and there may be other rights which may vary from state to state.

IV. HOW TO GET WARRANTY SERVICE:

You must provide proof of purchase (bearing the date of purchase and Product item serial number) in order to receive warranty service and, also, deliver or send the Product item, transportation and insurance prepaid, to an authorized warranty service location. Warranty service will be provided by MOTOROLA through one of its authorized warranty service locations. If you first contact the company which sold you the Product (e.g., dealer or communication service provider), it can facilitate your obtaining warranty service.

V. WHAT THIS WARRANTY DOES NOT COVER:

- A) Defects or damage resulting from use of the Product in other than its normal and customary manner.
- B) Defects or damage from misuse, accident, water, or neglect.

- C) Defects or damage from improper testing, operation, maintenance, installation, alteration, modification, or adjustment.
- D) Breakage or damage to antennas unless caused directly by defects in material workmanship.
- E) A Product subjected to unauthorized Product modifications, disassembles or repairs (including, without limitation, the addition to the Product of non-MOTOROLA supplied equipment) which adversely affect performance of the Product or interfere with MOTOROLA's normal warranty inspection and testing of the Product to verify any warranty claim.
- F) Product which has had the serial number removed or made illegible.
- G) Rechargeable batteries if:
 - (1) any of the seals on the battery enclosure of cells are broken or show evidence of tampering.
 - (2) the damage or defect is caused by charging or using the battery in equipment or service other than the Product for which it is specified.
- H) Freight costs to the repair depot.
- I) A Product which, due to illegal or unauthorized alteration of the software/firmware in the Product, does not function in accordance with MOTOROLA's published specifications or the FCC certification labeling in effect for the Product at the time the Product was initially distributed from MOTOROLA.
- J) Scratches or other cosmetic damage to Product surfaces that does not affect the operation of the Product.
- K) Normal and customary wear and tear.

VI. PATENT AND SOFTWARE PROVISIONS:

MOTOROLA will defend, at its own expense, any suit brought against the end user purchaser to the extent that it is based on a claim that the Product or parts infringe a United States patent, and MOTOROLA will pay those costs and damages finally awarded against the end user purchaser in any such suit which are attributable to any such claim, but such defense and payments are conditioned on the following:

- A) that MOTOROLA will be notified promptly in writing by such purchaser of any notice of such claim;
- B) that MOTOROLA will have sole control of the defense of such suit and all negotiations for its settlement or compromise; and
- C) should the Product or parts become, or in MOTOROLA's opinion be likely to become, the subject of a claim of infringement of a United States patent, that such purchaser will permit MOTOROLA, at its option and expense, either to procure for such purchaser the right to continue using the Product or parts or to replace or modify the same so that it becomes non-infringing or to grant such purchaser a credit for the Product or parts as depreciated and accept its return. The depreciation will be an equal amount per year over the lifetime of the Product or parts as established by MOTOROLA.

MOTOROLA will have no liability with respect to any claim of patent infringement which is based upon the combination of the Product or parts furnished hereunder with software, apparatus or devices not furnished by MOTOROLA, nor will MOTOROLA have any liability for the use of ancillary equipment or software not furnished by MOTOROLA which is attached to or used in connection with the Product. The foregoing states the entire liability of MOTOROLA with respect to infringement of patents by the Product or any parts thereof.

Laws in the United States and other countries preserve for MOTOROLA certain exclusive rights for copyrighted MOTOROLA software such as the exclusive rights to reproduce in copies and distribute copies of such MOTOROLA software. MOTOROLA software may be used in only the Product in which the software was originally embodied and such software in such Product may not be replaced, copied, distributed, modified in any way, or used to produce any derivative thereof. No other use including, without limitation, alteration, modification, reproduction, distribution, or reverse engineering of such MOTOROLA software or exercise of rights in such MOTOROLA software is permitted. No license is granted by implication, estoppel or otherwise under MOTOROLA patent rights or copyrights.

VII. GOVERNING LAW:

This Warranty is governed by the laws of the State of Illinois, U.S.A.