

Relay Module

KFD2-RSH-1.2D.FL2

- 1-channel signal conditioner
- 24 V DC supply
- Logic input 19 V DC ... 26.4 V DC
- Recommended connectable voltage 8 V DC ... 60 V DC
- Relay contact output for de-energized to safe function
- Line fault transparency (LFT)
- Diagnostic function
- Up to SIL 3 acc. to IEC/EN 61508
- Up to PL e acc. to EN/ISO 13849



Function

This signal conditioner provides the galvanic isolation between field circuits and control circuits. The device is a relay module that is suitable for safely switching applications of a load circuit. The device isolates load circuits up to 60 V DC and the 24 V DC control circuit. The de-energized to safe (DTS) function is permitted for SIL 3 and PL e applications. An internal fault or a line fault is signaled by the impedance change of the relay contact input and an additional relay contact output. A fault is signaled by LEDs and a separate collective error message output. The output must be protected against contact welding by an internal fuse or an external current limitation.

Connection

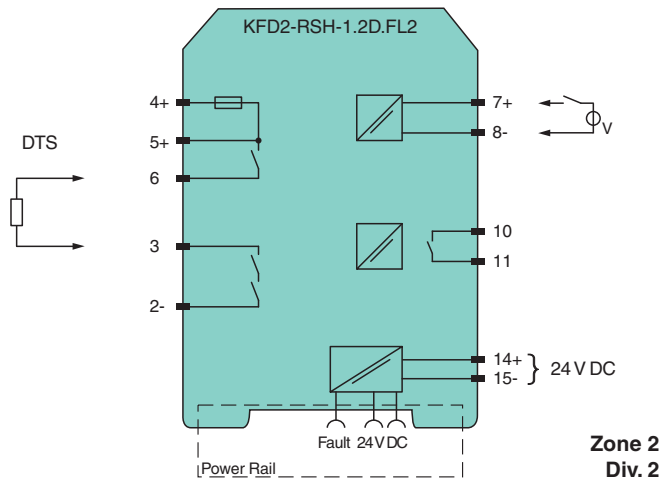

Zone 2
Div. 2

Technical Data

General specifications

Signal type Digital Output

Functional safety related parameters

Safety Integrity Level (SIL) SIL 3
 Systematic capability (SC) SC 3
 Performance level (PL) PL e

Supply

Connection Power Rail or terminals 14+, 15-
 Rated voltage U_r 19 ... 26.4 V DC
 Input current max. 35 mA at 24 V DC , max. 44 mA at 19 V DC , with enabled internal fault detection

Release date: 2022-02-15 Date of issue: 2022-02-15 Filename: 274893_eng.pdf

Refer to "General Notes Relating to Pepperl+Fuchs Product Information".

Pepperl+Fuchs Group
www.pepperl-fuchs.com

USA: +1 330 486 0002
pa-info@us.pepperl-fuchs.com

Germany: +49 621 776 2222
pa-info@de.pepperl-fuchs.com

Singapore: +65 6779 9091
pa-info@sg.pepperl-fuchs.com

PF PEPPERL+FUCHS

Technical Data

Power consumption		< 1.7 W , includes the power consumption of the digital input , see derating curves
Input		
Connection side		control side
Connection		terminals 7+, 8-
Pulse/Pause ratio		min. 150 ms / min. 150 ms with disabled internal fault detection min. 1 s / min. 1 s with enabled internal fault detection
Test pulse length		max. 2 ms from DO card
Signal level		0-signal: -5 ... 5 V DC 1-signal: 19 ... 26.4 V DC
Rated current	I_r	0-signal: typ. 1.6 mA at 1.5 V DC; typ. 8 mA at 3 V DC (maximum leakage current DO card) 1-signal: ≥ 36 mA (minimum load current DO card)
Inrush current		< 200 mA after 100 μ s
Output		
Connection side		field side
Connection		external voltage : terminals 4+, 5+, 2- load : terminals 6, 3
Connectable voltage		8 ... 60 V DC
Power dissipation		< 3.3 W at 5 A , see derating curves
Contact loading		30 V DC / 5 A resistive load , see derating curves
Minimum switch current		10 mA
Mechanical life		5 x 10 ⁶ switching cycles
Line fault detection		low voltage < 5 V DC undercurrent: 10 mA DC; overcurrent: 2.2 A DC (relay energized) breakage: 8.2 k Ω ; short-circuit: 11 Ω (load, relay de-energized)
Fuse rating		2.5 A (scope of delivery) max. 5 AT, recommended maximum utilization of the fuse: 80 %
Fault indication output		
Connection		terminals 10, 11
Contact loading		30 V DC/ 0.5 A resistive load
Reaction time		< 2 s
Mechanical life		10 ⁵ switching cycles
Transfer characteristics		
Switching frequency		< 3 Hz with disabled internal fault detection < 0.5 Hz with enabled internal fault detection
Galvanic isolation		
Input/power supply		basic insulation according to IEC/EN 61010-1, rated insulation voltage 60 V _{eff}
Input/fault indication output		basic insulation according to IEC/EN 61010-1, rated insulation voltage 30 V _{eff}
Output/other circuits		reinforced insulation according to IEC/EN 61010-1, rated insulation voltage 300 V _{eff}
Indicators/settings		
Display elements		LEDs
Control elements		DIP switch
Configuration		via DIP switches
Labeling		space for labeling at the front
Directive conformity		
Electromagnetic compatibility		
Directive 2014/30/EU		EN 61326-1:2013 (industrial locations)
Machinery Directive		
Directive 2006/42/EC		EN 62061:2005+AC:2010+A1:2013+A2:2015 , EN/ISO 13849-1:2015
Conformity		
Electromagnetic compatibility		NE 21:2017 , IEC/EN 61326-3-2:2018 , EN 61326-3-1:2017
Degree of protection		IEC 60529:2013
Protection against electrical shock		EN 61010-1:2010
Ambient conditions		
Ambient temperature		-20 ... 60 °C (-4 ... 140 °F) Observe the temperature range limited by derating, see section derating.
Mechanical specifications		

Release date: 2022-02-15 Date of issue: 2022-02-15 Filename: 274893_eng.pdf

Technical Data

Degree of protection	IP20
Connection	screw terminals
Mass	approx. 142 g
Dimensions	20 x 119 x 115 mm (0.8 x 4.7 x 4.5 inch) (W x H x D) , housing type B2
Mounting	on 35 mm DIN mounting rail acc. to EN 60715:2001
Data for application in connection with hazardous areas	
Certificate	PF 17 CERT 4305 X
Marking	Ⓜ II 3G Ex nC ec IIC T4 Gc [device in zone 2]
Directive conformity	
Directive 2014/34/EU	EN 60079-0:2012+A11:2013 , EN 60079-7:2015 , EN 60079-15:2010
International approvals	
UL approval	E106378
General information	
Supplementary information	Observe the certificates, declarations of conformity, instruction manuals, and manuals where applicable. For information see www.pepperl-fuchs.com .

Assembly

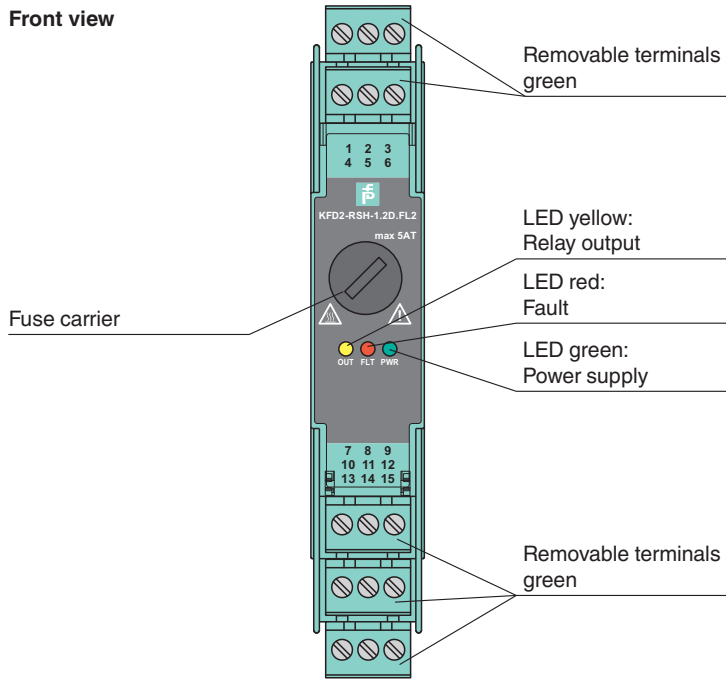



Matching System Components

	KFD2-EB2	Power Feed Module
	UPR-03	Universal Power Rail with end caps and cover, 3 conductors, length: 2 m
	UPR-03-M	Universal Power Rail with end caps and cover, 3 conductors, length: 1,6 m
	UPR-03-S	Universal Power Rail with end caps and cover, 3 conductors, length: 0.8 m



Release date: 2022-02-15 Date of issue: 2022-02-15 Filename: 274893_eng.pdf

Refer to "General Notes Relating to Pepperl+Fuchs Product Information".

Matching System Components

	K-DUCT-GY	Profile rail, wiring comb field side, gray
	K-DUCT-GY-UPR-03	Profile rail with UPR-03-* insert, 3 conductors, wiring comb field side, gray

Accessories

	KF-ST-5GN	Terminal block for KF modules, 3-pin screw terminal, green
	KF-CP	Red coding pins, packaging unit: 20 x 6

Configuration

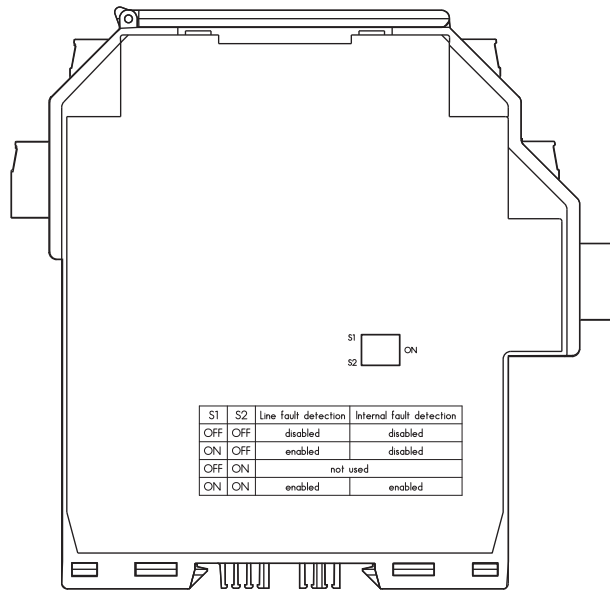

Output switch settings

S1	S2	Line fault detection	Internal fault detection
OFF	OFF	disabled	disabled
ON	OFF	enabled	disabled
OFF	ON	not used	
ON	ON	enabled	enabled

Factory settings: line fault detection enabled, internal fault detection enabled

During a switching event the device detects an internal fault. A full test of all 3 redundant relay channels requires 3 consecutive switching events.

Characteristic Curve

Derating

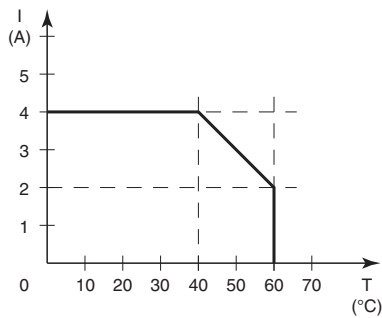

— fused, non-hazardous area
U_i 26.4 V

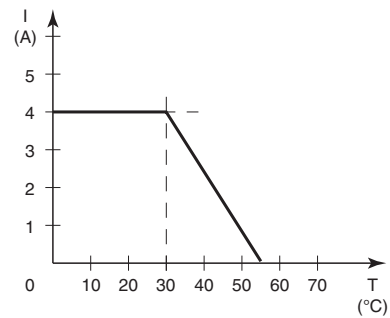

— fused, Zone 2
U_i 26.4 V

Release date: 2022-02-15 Date of issue: 2022-02-15 Filename: 274893_eng.pdf

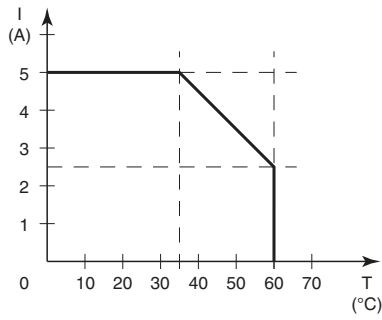

— unfused, non-hazardous area
 U_i 26.4 V

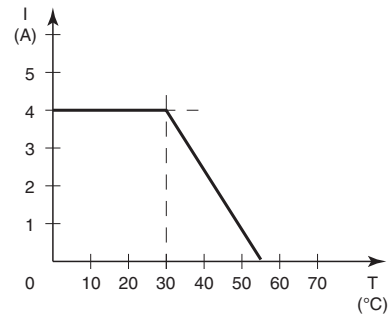

— unfused, Zone 2
 U_i 26.4 V

Characteristic Curve

Maximum Switching Power of Output Contacts

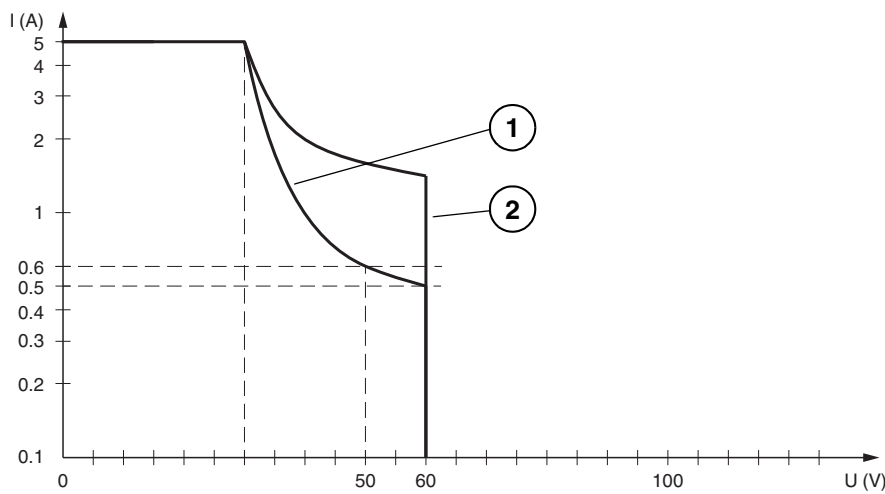

— Resistive load DC
1 max. 10^5 switching cycles
2 max. 3×10^4 switching cycles

The maximum number of switching cycles is depending on the electrical load and may be higher if reduced currents and voltages are applied.