

DISTRIBUTOR

INSTRUCTION MANUAL

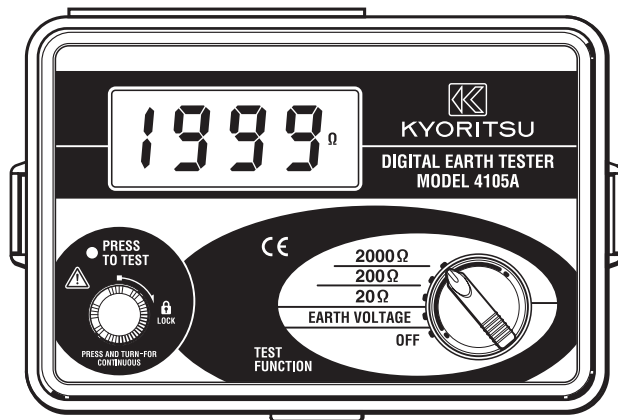

Kyoritsu reserves the rights to change specifications or designs described in this manual without notice and without obligations.



**KYORITSU ELECTRICAL
INSTRUMENTS
WORKS, LTD.**

No.5-20,Nakane 2-chome, Meguro-ku, Tokyo
152-0031 Japan
Phone : (03) 3723-0131 Fax : (03) 3723-0152
URL : <http://www.kew-ltd.co.jp>
E-mail : info@kew-ltd.co.jp
Factories : Uwajima & Ehime

Digital Earth Resistance Tester

MODEL 4105A

**KYORITSU ELECTRICAL INSTRUMENTS
WORKS, LTD.**

CONTENTS

1. Safety Precautions	1
2. Features	4
3. Specifications	5
4. Layout Diagram	8
5. Preparation for Measurement	9
5-1 Battery Voltage Check	9
5-2 Connecting Test Probes	9
6. Operating Instructions	9
6-1 Principle of Measurement	9
6-2 Precise Measurement	10
6-3 Simplified Measurement	11
7. Battery Replacement	14
8. Notes on Housing Case & Accessories	15
8-1 Case Lid.....	15
8-2 How to Fit Strap Belt	15
9. Before Sending for Service	16
10. Service	17

1. Safty Precautions

○ The instrument is designed, manufactured, tested and shipped in prime condition in accordance with the following standards.

- IEC 61010-1 Overvoltage CAT III 300V Pollution Degree 2
- IEC 61010-2-31
- IEC 61557-1,5
- IEC 60529 (IP54)

This instruction manual contains warnings and safety rules which must be observed by the user to ensure safety operation of the instrument and to retain it in safe condition. Therefore, read through these instructions before using the instrument.

⚠ WARNING

- Read through and understand instructions contained in this manual before using the instrument.
- Save and keep the manual handy to enable quick reference whenever necessary.
- Be sure to use the instrument only in its intended applications and to follow measurement procedures described in the manual.
- Be sure to understand and follow all safety instructions contained in the manual.

Be sure to observe the above rules strictly. Not following the instructions may cause injury or instrument damage.

○ The symbol ⚠ on the instrument means that the user must refer to the manual for safe operation of the instrument. There are three kinds of the symbol ⚠. Read the instructions following each symbol carefully.

⚠ DANGER is reserved for conditions and actions that are likely to cause serious or fatal injury.

⚠ WARNING is reserved for conditions and actions that can cause serious or fatal injury.

⚠ CAUTION is reserved for conditions and actions that can cause minor injury or instrument damage.

⚠ DANGER

- Make sure that the range selector switch is set to a desired position before making measurement.
- Do not make measurement in the presence of flammable gasses. Otherwise, the use of the instrument may cause sparking, which leads to an explosion.
- Never attempt to connect the test probe if the instrument or your hand is wet.
- Do not apply an electrical quantity exceeding the allowable limit of a measuring range.
- Never open the battery compartment cover while making measurement.

⚠ WARNING

- Never attempt to make measurement, if any abnormal conditions are noted, such as broken case, cracked test probe and exposed metal parts.
- Never turn the range selector switch with test probe connected to the equipment under test.
- Do not install substitute parts or make any decomposition or modification to the instrument. Return the instrument to Kyoritsu or your distributor for repair or re-calibration.
- Do not replace batteries when the surface of the instrument is wet.
- Always set the range switch to the OFF position before opening the battery compartment cover for battery replacement.

⚠ CAUTION

- Make sure that the test probe are securely connected to the terminal of the instrument.
- Be sure to set the range selector switch to the OFF position after use. When the instrument will not be in use for a long period of time, place it in storage after removing the batteries.
- Do not expose the instrument to the direct sun, extreme temperature and humidity or dew fall.
- Use a damp cloth soaked in water or neutral detergent for cleaning the instrument. Do not use abrasives or solvents.
- When the instrument is wet, make sure to let it dry before putting it in storage.

2. Features

MODEL 4105A is an earth resistance tester for testing power distribution lines, in-house wiring system, electrical appliances etc. It also has an earth voltage range for earth voltage measurement.

- Designed to safety standard IEC 61557.
- Dust and drip proof construction in conformity with IEC 60529 (IP54).
Measurement can be made even under adverse weather conditions.
- Large, easy-to-read LCD digital display.
- Simplified measurement probe has a structure that both the alligator clip and the test bar are available.
- Warns when earth resistance of auxiliary earth spikes exceeds the permissible limit.
- Convenient carrying soft bag for accessories etc.

3. Specifications

- Measuring Range and Accuracy (at $23 \pm 5^{\circ}\text{C}$ and RH 75% or less)

Range	Measuring Range	Accuracy
Earth Voltage	0 - 199.9V	$\pm 1.0\%$ rdg ± 4 dgt
Earth Resistance	20 Ω	$\pm 2.0\%$ rdg $\pm 0.1\Omega$ (0 - 19.99 Ω)
	200 Ω	$\pm 2.0\%$ rdg ± 3 dgt(above 20 Ω) (Auxiliary earth resistance 100 Ω $\pm 5\%$)
	2000 Ω	(Earth voltage 10V or less)

- Electromagnetic compatibility(Radiated RF immunity & IEC61000-4-3)
RF field strength = $\leq 1\text{V/m}$, total accuracy : specified accuracy
RF field strength = 3V/m , total accuracy : specified accuracy +5% of range
- Applicable Standards
 - IEC 61010-1 Overvoltage CAT III 300V Pollution Degree 2
 - IEC 61010-2-31
 - IEC 61557-1,5
 - IEC 60529 (IP54)
- Measuring Method
 - Earth voltage measurement
Average sensing
 - Earth resistance measurement
Constant current inverter
Frequency : Approx. 820Hz
Measuring current : 20 Ω range Approx. AC 3mA

○ Maximum Operating Error

Operating error (B) is an error obtained within the rated operating conditions, and calculated with the intrinsic error (A), which is an error of the instrument used, and the error (Ei) due to variations.

$$B = \pm (| A | + 1.15 \times \sqrt{E_1^2 + E_2^2 + E_3^2 + E_4^2 + E_5^2 + E_7^2 + E_8^2})$$

A : Intrinsic error

E₁ : Variation due to changing the position

E₂ : Variation due to changing the supply voltage

E₃ : Variation due to changing the temperature

E₄ : Variation due to series interference voltage

E₅ : Variation due to resistance of the probes and auxiliary earth electrode resistance

E₇ : Variation due to changing the system frequency

E₈ : Variation due to changing the system voltage

○ Range to keep the maximum operating error

Measurement range within which the maximum operating error ($\pm 30\%$) applies.

20 Ω range : 5-19.99 Ω

200 Ω range : 20-199.9 Ω

2000 Ω range : 200-1999 Ω

○ Number of Measurement

3300 times or more

(Measure 10 Ω for 5s on 20 Ω range and take a pause for 25s)

○ Operating Temperature and Humidity

0 - 40°C, relative humidity 85% or less (no condensation)

○ Storage Temperature and Humidity

-20 - 60°C, relative humidity 75% or less (no condensation)

○ Power Source

9V DC : R6P (SUM-3) x6

○ Overload Protection

Earth resistance ranges : 280V AC/DC (10 seconds)

Earth voltage range : 300V AC/DC (1 minute)

○ Insulation Resistance

5M Ω or more at 500V between the electrical circuit and the housing case

○ Withstand Voltage

3700V AC for one minute between the electrical circuit and the housing case

○ Dimensions

105(L) x 158(W) x 70(D) mm

○ Weight

Approx. 550g

○ Accessories

M-7095	Test Leads	x 1 set
M-8032	Auxiliary Earth Spikes	x 2
M-7127	Simplified Measurement Probe	x 1 set
	(with safety alligator clip and flat test bar)	
M-9084	Carrying Case	x 1
	Strap Belt	x 1
	Instruction Manual	x 1
	Battery R6P (SUM-3)	x 6

4. Layout Diagram

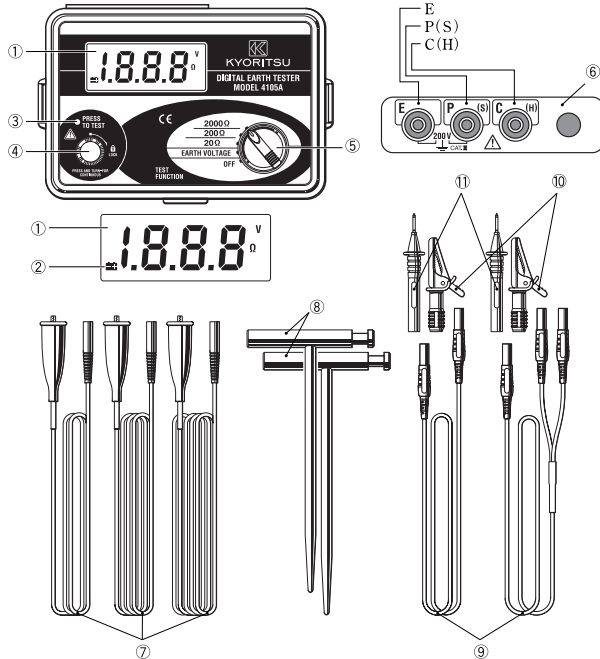

- | | |
|---------------------------------------------|----------------------------------------------------|
| ① LCD Display | ② Battery Replacement Mark
(Low Battery Symbol) |
| ③ Indication LED With
Measurement(Green) | ④ Press To Test Button |
| ⑤ Range Selector Switch | ⑥ Measuring Terminals |
| ⑦ Test Leads | ⑧ Auxiliary Earth Spikes |
| ⑨ Simplified Measurement Probe | ⑩ Safety Alligator Clip |
| ⑪ Test Bar | |

5. Preparation for Measurement

5-1 Battery Voltage Check

Turn on the instrument. If the display is clear without low battery symbol "🔋" showing, battery voltage is sufficient. If the display blanks or "🔋" is indicated, replace the batteries according to section 7 for Battery Replacement.

5-2 Connecting Test Probe

Insert the plug of the probe securely into the terminals of the instrument. Loose connection may result in inaccurate measurements.

6. Operating Instructions

⚠ DANGER

- The instrument will produce a maximum voltage of about 50V between terminals E-C in earth resistance function. Take enough caution to avoid electric shock hazard.
- When measuring earth voltage, do not apply voltage greater than 200V between measuring terminals.
- When measuring earth resistance, do not apply voltage between measuring terminals.

6-1 Principle of Measurement

This instrument makes earth resistance measurement with fall-of-potential method, which is a method to obtain earth resistance value R_x by applying AC constant current I between the measurement object E (earth electrode) and C (current electrode), and finding out the potential difference V between E and P (potential electrode).

$$R_x = V / I$$

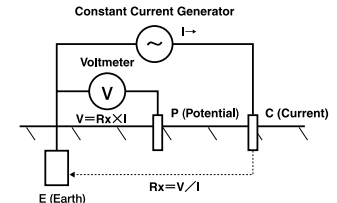

6-2 Precise Measurement (with Test Probe M-7095)

① Test probe connection

Stick the auxiliary earth spikes P and C into the ground deeply. They should be aligned at an interval of 5-10m from the earthed equipment under test. Connect the green wire to the earthed equipment under test, the yellow wire to the auxiliary earth spike P and the red wire to the auxiliary earth spike C from terminals E, P and C of the instrument in order.

Note : ◇ Make sure to stick the auxiliary earth spikes in the moist part of the soil. Give enough water where the spikes have to be stuck into the dry, stony or sandy part of the earth so that it may become moist.
◇ In case of concrete, lay the auxiliary earth spike down and water it, or put a wet dustcloth etc. on the spike when making measurement.

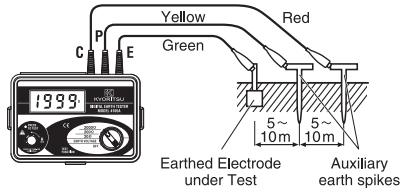

② Earth Voltage Measurement

Set the range switch to EARTH VOLTAGE position in the condition of ①. Earth voltage will be indicated on the display. Make sure that the voltage is 10V or less.

When the display reads more than 10V, it may result in excessive errors in earth resistance measurement. To avoid this, make measurement after reducing the voltage by turning off the power supply of the equipment under test etc.

③ Precise Measurement

Set the range switch to 2000Ω position and press the test button. LED remains illuminated during testing. Turn the range switch to 200Ω and

20Ω when the earth resistance is low. This indicated value is the earth resistance of the earthed equipment under test.

Note : ◇ If the auxiliary earth resistance of auxiliary earth spike C is too high to make measurement, the display reads '...'. Recheck the connection of test leads and the earth resistance of auxiliary earth spike.

⚠ CAUTION

- If measurement is made with the probes twisted or in touch with each other, the reading of the instrument may be affected by induction. When connecting the probes, make sure that they are separated.
- If earth resistance of auxiliary earth spikes is too large, it may result in inaccurate measurement. Make sure to stick the auxiliary earth spike P and C into the moist part of the earth carefully, and ensure sufficient connections between the respective connections.

6-3 Simplified Measurement (with Test Probe M-7127)

Use this method when the auxiliary earth spike cannot be stuck. In this method, an existing earth electrode with a low earth resistance, such as a metal water pipe, a common earth of a commercial power supply and an earth terminal of a building, can be used with two-terminal method (E,P).

Use the simplified measurement probe attached which has a convenient structure that both the safety alligator clip and the test bar are available.

① Wiring

Make connection as shown in the figure.

Note : ◇ When the simplified measurement probes are not used, short P and C terminals.

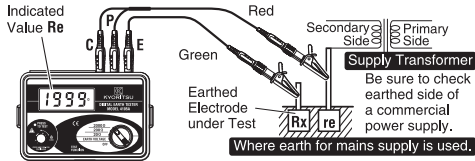

⚠ DANGER

- Please be sure to use a voltage detector to check a common earth of commercial power supply.
- Do not use the instrument to check a common earth of commercial power supply.

A danger will be caused because the voltage may not be displayed even in case of a live conductor when the connection of the earth electrode to be measured has come off, or when the connection of the test leads of the instrument is not correct etc.

- Do not use the instrument to measure the voltage of commercial power supply.

The instrument is not designed for voltage measurement of commercial power supply. When using the adjunctive simplified measurement probe MODEL 7127, P and C terminals will be short-circuited and the input impedance will be reduced. The residual current circuit breaker may operate when making measurement of the voltage in the circuit with the breaker.

② Earth Voltage Measurement

Set the range switch to EARTH VOLTAGE position in the condition of ①. Earth voltage will be indicated on the display. Make sure that the voltage is 10V or less.

When the display reads more than 10V, it may result in excessive errors in earth resistance measurement. To avoid this, make measurement after reducing the voltage by turning off the power supply of the equipment under test etc.

③ Simplified Measurement

Set the range switch to 2000Ω position and press the test button. LED remains illuminated during testing. Turn the range switch to 200Ω and 20Ω when the earth resistance is low. This indicated value is the earth resistance of the earthed equipment under test.

Note : ◇ If the auxiliary earth resistance of auxiliary earth spike C is too high to make measurement, the display reads '...'. Recheck the connection of each test lead and the earth resistance of auxiliary earth spike.

④ Simplified Measurement Value

Two-terminal method is used for simplified measurement. In this method, earth resistance value **re** of earth electrode connected to terminal P is added to true earth resistance value **Rx** and shown as an indicated value **Re**.

$$\mathbf{Re = Rx + re}$$

If the **re** is known beforehand, true earth resistance value **Rx** is calculated as follows.

$$\mathbf{Rx = Re - re}$$

7. Battery Replacement

⚠ DANGER

- Never attempt to open the battery compartment cover, if the outer surface of the instrument is wet.
- Never attempt to replace batteries while making measurement. To avoid shock hazard, turn the instrument off and disconnect the test leads and the probes from the instrument before opening the battery compartment cover.

⚠ CAUTION

- Do not mix new and old batteries.
- Install batteries in the orientation as shown inside the battery compartment, observing correct polarity.

- ① Turn off the instrument and disconnect the test probes from the terminals.
- ② Loosen two screws on the bottom of the instrument and remove the battery cover.
- ③ Always replace all six batteries in correct polarity.
Battery : R6P (AA dry battery) x6
- ④ Put the cover back in place and tighten the two screws.

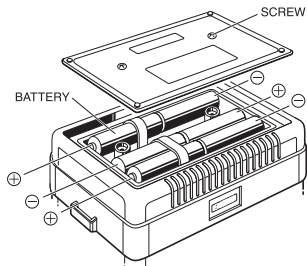

8. Notes on Housing Case & Accessories

8-1 Case Lid

Case lid can be fit under the housing case while making measurement.

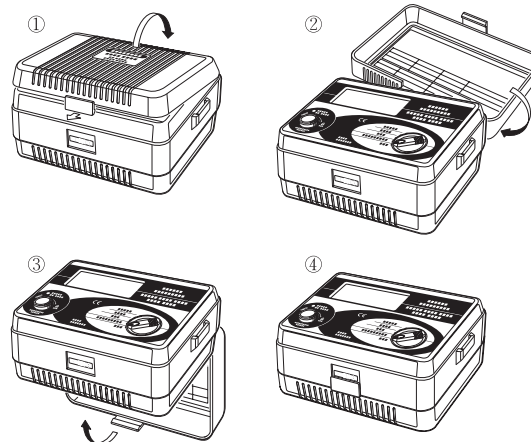

8-2 How to Fit Strap Belt

The instrument is equipped with a strap belt to suspend from the neck to allow both hands to be used freely for easy and safe operation

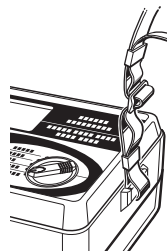

9. Before Sending for Service

If this instrument should fail to operate correctly, return it to your nearest distributor stating the exact nature of the fault. Before returning the instrument follow the trouble-shooting guide shown below.

- If the instrument does not turn on;
Check whether batteries are missing or they are installed incorrect polarity. Note that batteries were not installed in the instrument at the time of shipment.

- If the display reads '1...' in earth voltage measurement;
A voltage exceeding 200V is being applied to the instrument.
Halt the measurement immediately, otherwise the instrument may be damaged.

- If the display reads '...' in normal earth resistance measurement;
Stick the auxiliary earth spikes deeper into the earth, or stick them at other locations; or
Add moisture to the part of the earth where C auxiliary earth spike is stuck (connected with the red wire); and
Short the three test leads and check if the display indicates a value near ' 0.00 '. (See section 6 for details.)

- If the display reads '...' in simplified earth resistance measurement;
Check if the connection to a metal water pipe, a common earth of commercial power supply, etc., is secure; or
Use another metal water pipe, common earth of commercial power supply, etc.

10. Service

If this instrument should fail to operate correctly, return to your nearest distributors stating the exact nature of the fault.