

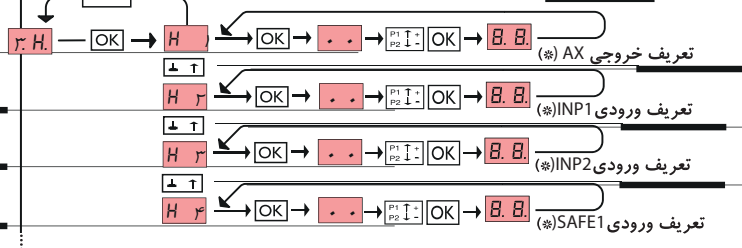

The descriptions and illustrations contained in the present manual are not binding. The Company reserves the right to make any alterations deemed appropriate for the technical improvement of products.

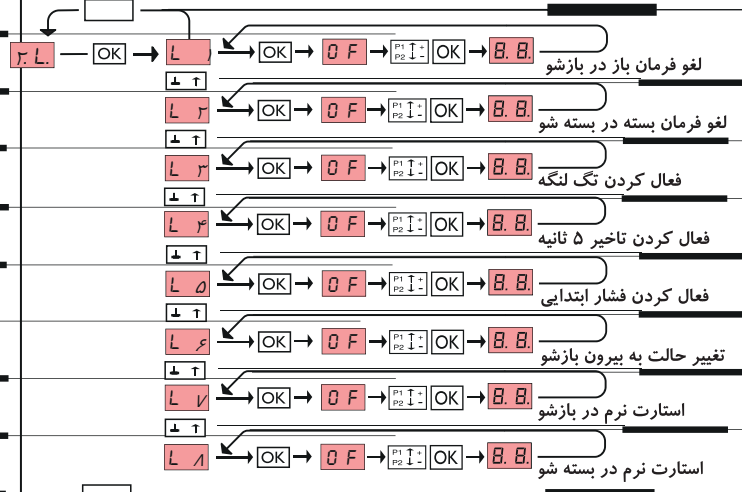
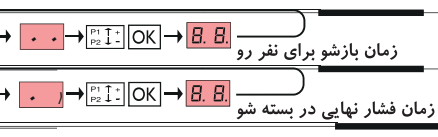
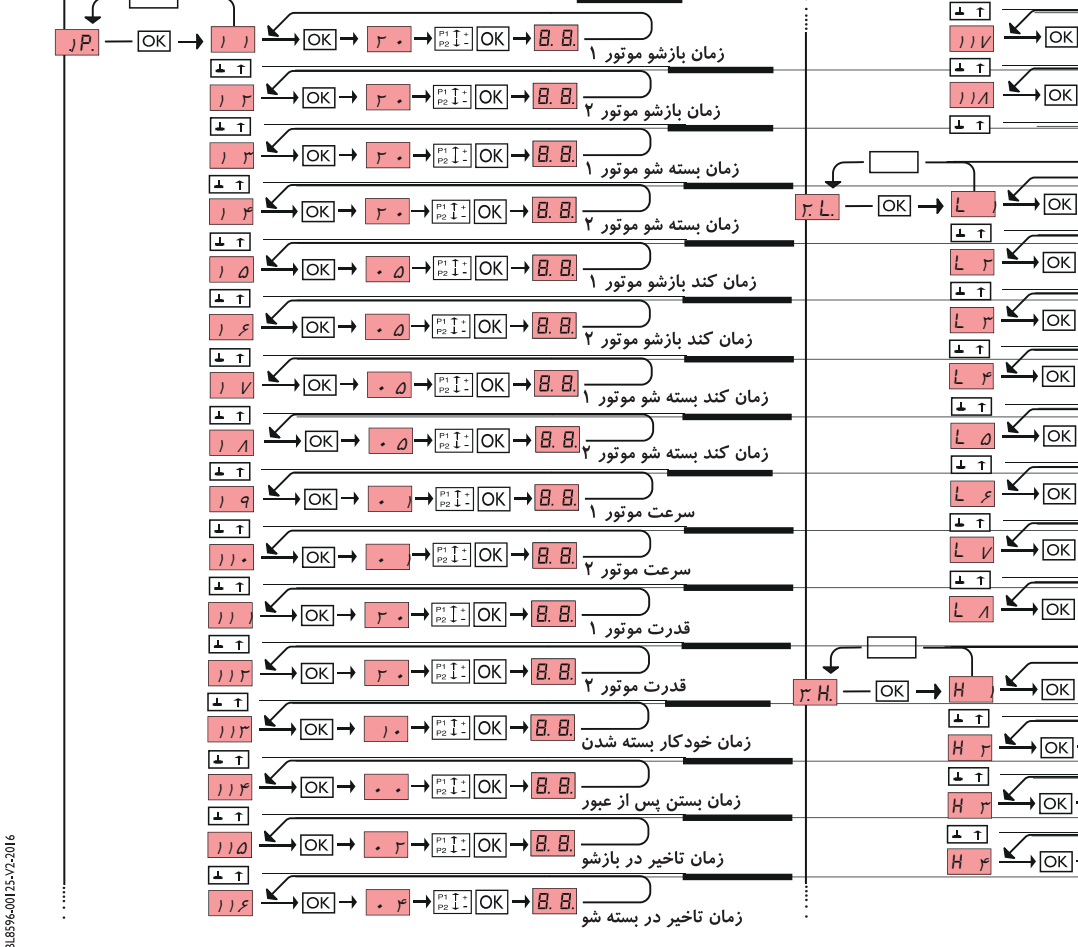
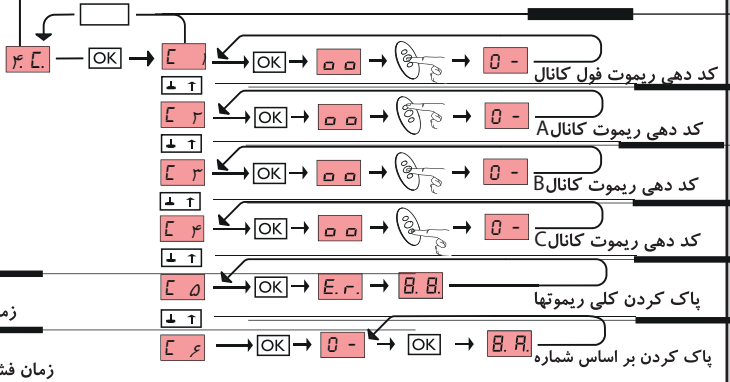
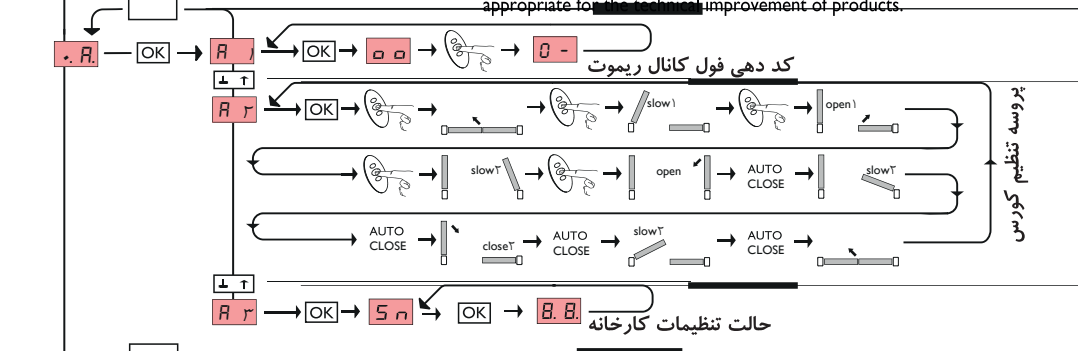
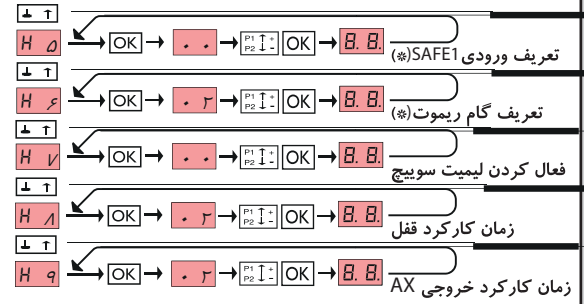
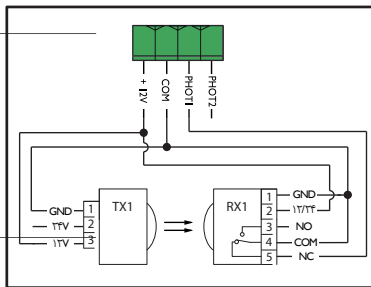
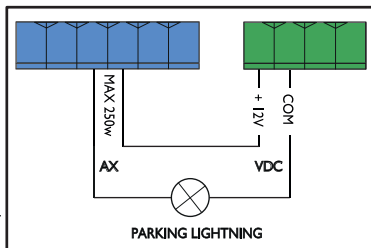

تعاریف منوهای برنامه پذیر (\*)

تعریف ورودی	فرمان	دوگام
0	فرمان بازشو	دوگام
1	فرمان بسته شو	سه گام
2	فرمان تغییر جهت	چهارگام

تعریف ورودی	فرمان	کانال دوم ریموت
0	فرمان استارت	0
1	فرمان بازشو	1
2	فرمان بسته شو	2
3	فرمان تک لنگه	3
4	فرمان نفررو	4
5	فرمان تایمر	5

www.DigiDsc.com  
44748478 - 44757973





This document was created with the Win2PDF "print to PDF" printer available at <http://www.win2pdf.com>

This version of Win2PDF 10 is for evaluation and non-commercial use only.

This page will not be added after purchasing Win2PDF.

<http://www.win2pdf.com/purchase/>