

PRO-60 HP | PORTABLE HYDRAULIC PUNCHERS

PRO-110 HP



Primary features and benefits:

- Double action - fully automated process of punching and return
- Wide range of hole diameters up to 27mm
- Modern construction
- Intelligent control system with inching and automatic load detection
- Mode indicator light
- Protection against accidental start-up
- Easy to handle in out-of-normal positions
- All connecting ports located at the back
- Wide range of special-shaped punches and dies
- Patent pending compact moveable hydraulic power pack
- Unique Gantry Punching Station increases both productivity and operator's comfort



| | max. thickness | max. throat depth | max. hole | max. oblong hole | punching time | punching power | double action hydraulic movement |
|--|----------------|-------------------|-----------|------------------|---------------|----------------|----------------------------------|

| | | | | | | | |
|------------|-------|--------|-------|------------|-------|--------|-----|
| PRO 60 HP | 13 mm | 60 mm | 27 mm | 25 x 18 mm | 5 sec | 35 ton | YES |
| PRO 110 HP | 16 mm | 110 mm | 27 mm | 25 x 18 mm | 8 sec | 47 ton | YES |

| Portable Double-Action Hydraulic Puncher Technical Specification | model PRO 60 HP | model PRO 110 HP |
|--|---------------------|---------------------|
| Max. throat depth | 60 mm | 110 mm |
| Max. hole | ∅ 27 mm | ∅ 27 mm |
| Max. oblong hole | 25 x 18 mm | 25 x 18 mm |
| Punching time | 5 sec | 8 sec |
| Max. plate thickness | 13 mm | 16 mm |
| Punching power | 35 ton | 47 ton |
| Working pressure | 700 bar | 700 bar |
| Weight | 20 kg | 35 kg |
| Product code | GLW-0522-10-00-00-1 | GLW-0507-10-00-00-0 |

Overall dimensions

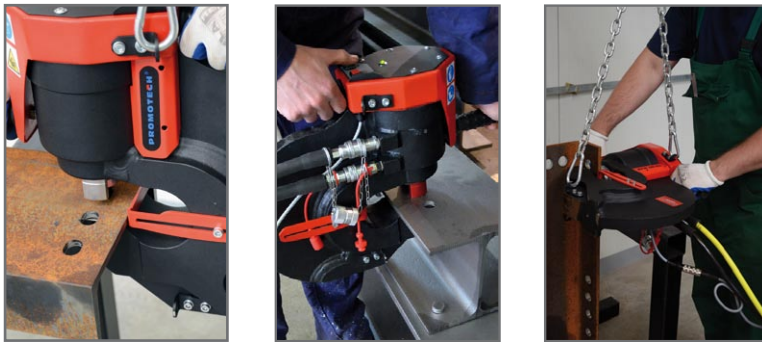
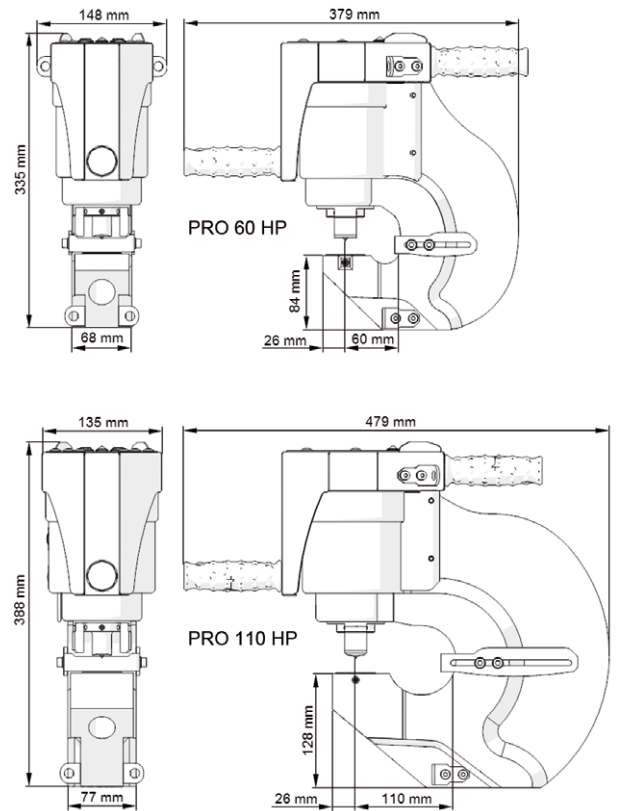

Ready to work in both vertical and horizontal positions

| Double-Action Hydraulic Power Pack model HPP 700/1.5 | |
|--|----------------------------|
| Power supply* | 230V/50Hz; 115V/60Hz |
| Motor power | 1500 W |
| Working pressure | 700 bar |
| Pump output | 1.5 L/min |
| Oil capacity | 10 L |
| Product code | ZSL-0517-10-20-00-0 |
| | HPP-700/1,5 /220-240V/50Hz |

* Contact Promotech for other voltage options



Portable hydraulic power pack with shelf for puncher transport.



Ergonomic location of ports at the back



Balancer for PRO 60 HP
Product code: BLN-000004

Balancer for PRO 110 HP
Product code: BLN-000005

Customize your work place with a variety of optional accessories.

Hoist set

Product code: ZUR-0517-15-00-00-0



Simple set-up and easy adjustment of height and balance control.



Hoist arm and 2 supports with wheels allow for easy manipulation of punch and power pack as single unit.

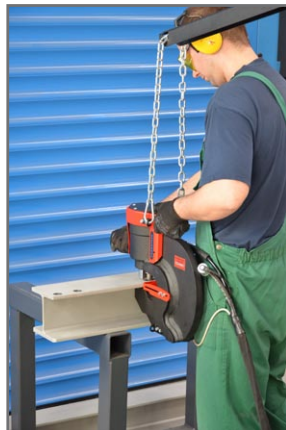

Unique solution which makes your work as efficient and comfortable as never before.

Wheel puncher slide

Product code: PRW-0507-90-00-00-0

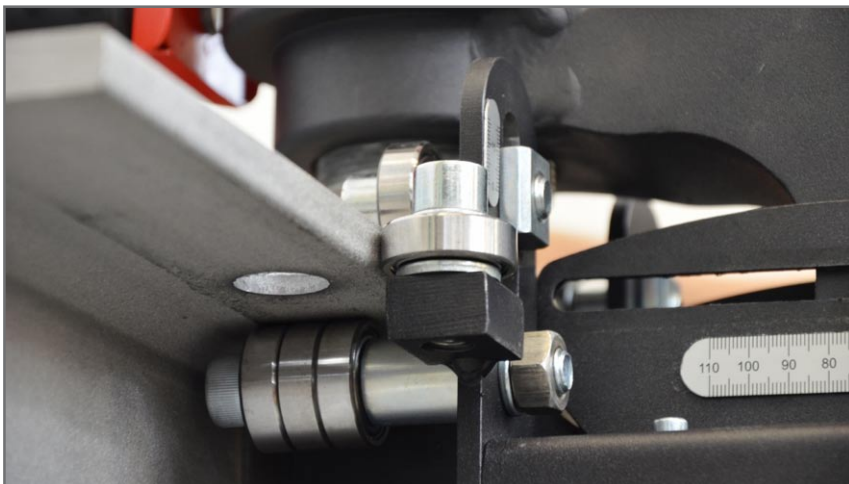

Permits smooth and efficient lineal movement along the workpiece.



Bench top stand with foot pedal

Product code: ZST-0507-91-00-00-0



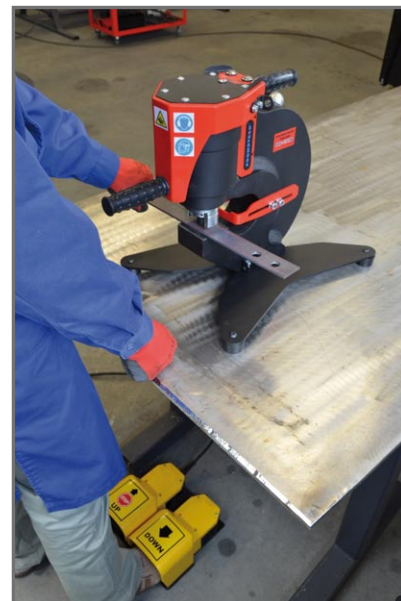

Neither balancer nor hoist arm is required to keep puncher in place.
An operator can use start and stop buttons on the machine or foot pedals.





Foot pedal machine control in hands free operation on bench top configuration.

Punches & dies

| Hydraulic Punchers tools |  |  |
|--------------------------|---|---|
| Oblong [mm] | Punch - product code | Die - product code |
| 16x8 | STM-0507-30-13-00-0 | MTY-0507-70-13-00-0 |
| 18x9 | STM-0507-30-12-00-0 | MTY-0507-70-12-00-0 |
| 18x11 | STM-0507-30-11-00-0 | MTY-0507-70-11-00-0 |
| 20x10 | STM-0507-30-10-00-0 | MTY-0507-70-10-00-0 |
| 20x12 | STM-0507-30-09-00-0 | MTY-0507-70-09-00-0 |
| 20x14 | STM-0507-30-08-00-0 | MTY-0507-70-08-00-0 |
| 22x11 | STM-0507-30-07-00-0 | MTY-0507-70-07-00-0 |
| 22x14 | STM-0507-30-06-00-0 | MTY-0507-70-06-00-0 |
| 24x12 | STM-0507-30-05-00-0 | MTY-0507-70-05-00-0 |
| 25x9 | STM-0507-30-04-00-0 | MTY-0507-70-04-00-0 |
| 25x12 | STM-0507-30-03-00-0 | MTY-0507-70-03-00-0 |
| 25x13 | STM-0507-30-02-00-0 | MTY-0507-70-02-00-0 |
| 25x14 | STM-0507-30-01-00-0 | MTY-0507-70-01-00-0 |
| 25x18 | STM-0507-30-00-00-0 | MTY-0507-70-00-00-0 |

Various hydraulic punch tools are available on request in imperial or metric sizes.

| Hydraulic Punchers tools |  |  |  |
|--------------------------|---|--|--|
| Diameter [mm] | Punch - product code | Die - product code | Die 5° - product code |
| 7 | STM-0507-20-18-00-0 | MTY-0507-40-18-00-0 | - |
| 8 | STM-0507-20-17-00-0 | MTY-0507-40-17-00-0 | - |
| 9 | STM-0507-20-16-00-0 | MTY-0507-40-16-00-0 | MTY-0507-50-16-00-0 |
| 10 | STM-0507-20-15-00-0 | MTY-0507-40-15-00-0 | MTY-0507-50-15-00-0 |
| 11 | STM-0507-20-14-00-0 | MTY-0507-40-14-00-0 | MTY-0507-50-14-00-0 |
| 12 | STM-0507-20-13-00-0 | MTY-0507-40-13-00-0 | MTY-0507-50-13-00-0 |
| 13 | STM-0507-20-12-00-0 | MTY-0507-40-12-00-0 | MTY-0507-50-12-00-0 |
| 14 | STM-0507-20-11-00-0 | MTY-0507-40-11-00-0 | MTY-0507-50-11-00-0 |
| 15 | STM-0507-20-10-00-0 | MTY-0507-40-10-00-0 | MTY-0507-50-10-00-0 |
| 16 | STM-0507-20-09-00-0 | MTY-0507-40-09-00-0 | MTY-0507-50-09-00-0 |
| 17 | STM-0507-20-08-00-0 | MTY-0507-40-08-00-0 | MTY-0507-50-08-00-0 |
| 18 | STM-0507-20-07-00-0 | MTY-0507-40-07-00-0 | MTY-0507-50-07-00-0 |
| 19 | STM-0507-20-06-00-0 | MTY-0507-40-06-00-0 | MTY-0507-50-06-00-0 |
| 20 | STM-0507-20-05-00-0 | MTY-0507-40-05-00-0 | MTY-0507-50-05-00-0 |
| 21 | STM-0507-20-04-00-0 | MTY-0507-40-04-00-0 | MTY-0507-50-04-00-0 |
| 22 | STM-0507-20-03-00-0 | MTY-0507-40-03-00-0 | MTY-0507-50-03-00-0 |
| 23 | STM-0507-20-02-00-0 | MTY-0507-40-02-00-0 | MTY-0507-50-02-00-0 |
| 24 | STM-0507-20-01-00-0 | MTY-0507-40-01-00-0 | MTY-0507-50-01-00-0 |
| 25 | STM-0507-20-00-00-0 | MTY-0507-40-00-00-0 | MTY-0507-50-00-00-0 |
| 26 | STM-0507-20-19-00-0 | MTY-0507-40-19-00-0 | MTY-0507-50-19-00-0 |
| 27 | STM-0507-20-20-00-0 | MTY-0507-40-20-00-0 | MTY-0507-50-20-00-0 |

All information is subject to change without notice. 1504



PROMOTECH Sp. z o.o.
ul. Elewatorska 23/1, 15-620 BIAŁYSTOK, POLAND
tel. (+48 85) 678 34 05, fax (+48 85) 662 78 77
marketing@promotech.eu www.promotech.eu

Your local dealer:

