

# Pressure sensor

## For general industrial applications

### Model A-10

WIKA data sheet PE 81.60



for further approvals  
see page 9

#### Applications

- Machine building
- Shipbuilding
- Measurement and control technology
- Hydraulics and pneumatics
- Pumps and compressors

#### Special features

- Measuring ranges from 0 ... 0.05 to 0 ... 1,000 bar
- Non-linearity 0.25 % or 0.5 %
- Output 4 ... 20 mA, DC 0 ... 10 V, DC 0 ... 5 V and others
- Electrical connection: Angular connector form A and C, circular connector M12 x 1, cable outlet 2 m
- Process connection G 1/4 A DIN 3852-E, 1/4 NPT and others



Pressure sensor, model A-10

#### Description

The model A-10 pressure sensor for general industrial applications is not only notable for its compact design, but it also offers excellent quality at an extremely competitive price.

The user can choose between a non-linearity of 0.25 % and 0.5 %. A free test protocol provides information on the measuring points recorded during manufacture.

The model A-10 is set up for worldwide use through the international cULus and EAC certification. The various pressure units and process connections required for particular operating conditions are available at short notice.

## Measuring ranges

| Gauge pressure  |                        |                               |                               |                               |                   |                              |                              |                              |
|-----------------|------------------------|-------------------------------|-------------------------------|-------------------------------|-------------------|------------------------------|------------------------------|------------------------------|
| bar             | <b>Measuring range</b> | <b>0 ... 0.05</b>             | <b>0 ... 0.1</b>              | <b>0 ... 0.16</b>             | <b>0 ... 0.25</b> | <b>0 ... 0.4</b>             | <b>0 ... 0.6</b>             | <b>0 ... 1</b>               |
|                 | Overload safety        | 0.2                           | 0.2                           | 1                             | 1                 | 1                            | 3                            | 3                            |
|                 | <b>Measuring range</b> | <b>0 ... 1.6</b>              | <b>0 ... 2.5</b>              | <b>0 ... 4</b>                | <b>0 ... 6</b>    | <b>0 ... 10<sup>1)</sup></b> | <b>0 ... 16<sup>1)</sup></b> | <b>0 ... 25<sup>1)</sup></b> |
|                 | Overload safety        | 3.2                           | 5                             | 8                             | 12                | 20                           | 32                           | 50                           |
|                 | <b>Measuring range</b> | <b>0 ... 40</b>               | <b>0 ... 60</b>               | <b>0 ... 100</b>              | <b>0 ... 160</b>  | <b>0 ... 250</b>             | <b>0 ... 400</b>             | <b>0 ... 600</b>             |
|                 | Overload safety        | 80                            | 120                           | 200                           | 320               | 500                          | 800                          | 1,200                        |
|                 | <b>Measuring range</b> | <b>0 ... 1,000</b>            |                               |                               |                   |                              |                              |                              |
| Overload safety | 1,500                  |                               |                               |                               |                   |                              |                              |                              |
| inWC            | <b>Measuring range</b> | <b>0 ... 20</b>               | <b>0 ... 40</b>               | <b>0 ... 60</b>               | <b>0 ... 80</b>   | <b>0 ... 100</b>             | <b>0 ... 120</b>             | <b>0 ... 150</b>             |
|                 | Overload safety        | 84                            | 84                            | 400                           | 400               | 400                          | 400                          | 400                          |
|                 | <b>Measuring range</b> | <b>0 ... 200</b>              | <b>0 ... 250</b>              | <b>0 ... 400</b>              |                   |                              |                              |                              |
|                 | Overload safety        | 400                           | 1,200                         | 1,200                         |                   |                              |                              |                              |
| psi             | <b>Measuring range</b> | <b>0 ... 1</b>                | <b>0 ... 5</b>                | <b>0 ... 15</b>               | <b>0 ... 25</b>   | <b>0 ... 30</b>              | <b>0 ... 50</b>              | <b>0 ... 100</b>             |
|                 | Overload safety        | 3                             | 14.5                          | 45                            | 60                | 60                           | 100                          | 200                          |
|                 | <b>Measuring range</b> | <b>0 ... 160<sup>1)</sup></b> | <b>0 ... 200<sup>1)</sup></b> | <b>0 ... 300<sup>1)</sup></b> | <b>0 ... 500</b>  | <b>0 ... 1,000</b>           | <b>0 ... 1,500</b>           | <b>0 ... 2,000</b>           |
|                 | Overload safety        | 290                           | 400                           | 600                           | 1,000             | 1,740                        | 2,900                        | 4,000                        |
|                 | <b>Measuring range</b> | <b>0 ... 3,000</b>            | <b>0 ... 5,000</b>            | <b>0 ... 10,000</b>           |                   |                              |                              |                              |
| Overload safety | 6,000                  | 10,000                        | 17,400                        |                               |                   |                              |                              |                              |

1) If the medium water is measured, a higher overload safety is recommended.

| Absolute pressure |                        |                  |                   |                   |                  |                  |                  |                  |
|-------------------|------------------------|------------------|-------------------|-------------------|------------------|------------------|------------------|------------------|
| bar               | <b>Measuring range</b> | <b>0 ... 0.1</b> | <b>0 ... 0.16</b> | <b>0 ... 0.25</b> | <b>0 ... 0.4</b> | <b>0 ... 0.6</b> | <b>0 ... 1</b>   | <b>0 ... 1.6</b> |
|                   | Overload safety        | 1                | 1                 | 1                 | 1                | 3                | 3                | 3.2              |
|                   | <b>Measuring range</b> | <b>0 ... 2.5</b> | <b>0 ... 4</b>    | <b>0 ... 6</b>    | <b>0 ... 10</b>  | <b>0 ... 16</b>  | <b>0 ... 25</b>  |                  |
|                   | Overload safety        | 5                | 8                 | 12                | 20               | 32               | 50               |                  |
| inWC              | <b>Measuring range</b> | <b>0 ... 40</b>  | <b>0 ... 60</b>   | <b>0 ... 80</b>   | <b>0 ... 100</b> | <b>0 ... 120</b> | <b>0 ... 150</b> | <b>0 ... 200</b> |
|                   | Overload safety        | 400              | 400               | 400               | 400              | 400              | 400              | 400              |
|                   | <b>Measuring range</b> | <b>0 ... 250</b> | <b>0 ... 400</b>  |                   |                  |                  |                  |                  |
| Overload safety   | 1,200                  | 1,200            |                   |                   |                  |                  |                  |                  |
| psi               | <b>Measuring range</b> | <b>0 ... 5</b>   | <b>0 ... 15</b>   | <b>0 ... 25</b>   | <b>0 ... 30</b>  | <b>0 ... 50</b>  | <b>0 ... 100</b> | <b>0 ... 150</b> |
|                   | Overload safety        | 14.5             | 45                | 60                | 60               | 100              | 200              | 290              |
|                   | <b>Measuring range</b> | <b>0 ... 200</b> | <b>0 ... 300</b>  |                   |                  |                  |                  |                  |
|                   | Overload safety        | 400              | 600               |                   |                  |                  |                  |                  |

## Vacuum and +/- measuring range

|                        |                          |                                       |                                       |                                       |                                |                                |
|------------------------|--------------------------|---------------------------------------|---------------------------------------|---------------------------------------|--------------------------------|--------------------------------|
| <b>bar</b>             | <b>Measuring range</b>   | <b>-0.025 ... +0.025</b>              | <b>-0.05 ... 0</b>                    | <b>-0.05 ... +0.05</b>                | <b>-0.05 ... +0.15</b>         | <b>-0.05 ... +0.2</b>          |
|                        | Overload safety          | ±0.2                                  | ±0.2                                  | ±0.2                                  | 1                              | 1                              |
|                        | <b>Measuring range</b>   | <b>-0.05 ... +0.25</b>                | <b>-0.1 ... 0</b>                     | <b>-0.1 ... +0.1</b>                  | <b>-0.15 ... +0.15</b>         | <b>-0.16 ... 0</b>             |
|                        | Overload safety          | 1                                     | ±0.2                                  | 1                                     | 1                              | 1                              |
|                        | <b>Measuring range</b>   | <b>-0.2 ... +0.2</b>                  | <b>-0.25 ... 0</b>                    | <b>-0.25 ... +0.25</b>                | <b>-0.3 ... +0.3</b>           | <b>-0.4 ... 0</b>              |
|                        | Overload safety          | 1                                     | 1                                     | 1                                     | 3                              | 1                              |
|                        | <b>Measuring range</b>   | <b>-0.5 ... +0.5</b>                  | <b>-0.6 ... 0</b>                     | <b>-1 ... 0</b>                       | <b>-1 ... +0.6</b>             | <b>-1 ... +1.5</b>             |
|                        | Overload safety          | 3                                     | 3                                     | 3                                     | 3.2                            | 5                              |
|                        | <b>Measuring range</b>   | <b>-1 ... +3</b>                      | <b>-1 ... +5</b>                      | <b>-1 ... +9<sup>1)</sup></b>         | <b>-1 ... +15<sup>1)</sup></b> | <b>-1 ... +24<sup>1)</sup></b> |
| Overload safety        | 8                        | 12                                    | 20                                    | 32                                    | 50                             |                                |
| <b>inWC</b>            | <b>Measuring range</b>   | <b>-10 ... +10</b>                    | <b>-20 ... 0</b>                      | <b>-20 ... +20</b>                    | <b>-40 ... 0</b>               | <b>-40 ... +40</b>             |
|                        | Overload safety          | ±80                                   | ±80                                   | ±80                                   | ±80                            | ±80                            |
|                        | <b>Measuring range</b>   | <b>-50 ... +50</b>                    | <b>-60 ... 0</b>                      | <b>-75 ... +75</b>                    | <b>-80 ... 0</b>               | <b>-100 ... 0</b>              |
|                        | Overload safety          | 400                                   | 400                                   | 400                                   | 400                            | 400                            |
|                        | <b>Measuring range</b>   | <b>-100 ... +100</b>                  | <b>-120 ... 0</b>                     | <b>-125 ... +125</b>                  | <b>-150 ... 0</b>              | <b>-200 ... +200</b>           |
|                        | Overload safety          | 400                                   | 400                                   | 1,200                                 | 400                            | 1,200                          |
|                        | <b>Measuring range</b>   | <b>-250 ... 0</b>                     |                                       |                                       |                                |                                |
|                        | Overload safety          | 1,200                                 |                                       |                                       |                                |                                |
|                        | <b>psi</b>               | <b>Measuring range</b>                | <b>-1 ... 0</b>                       | <b>-30 inHg ... 0</b>                 | <b>-30 inHg ... +15</b>        | <b>-30 inHg ... +30</b>        |
| Overload safety        | ±3                       | 45                                    | 60                                    | 60                                    | 150                            |                                |
| <b>Measuring range</b> | <b>-30 inHg ... +100</b> | <b>-30 inHg ... +160<sup>1)</sup></b> | <b>-30 inHg ... +200<sup>1)</sup></b> | <b>-30 inHg ... +300<sup>1)</sup></b> |                                |                                |
| Overload safety        | 250                      | 350                                   | 450                                   | 600                                   |                                |                                |

1 ) If the medium water is measured, a higher overload safety is recommended.

The given measuring ranges are also available in mbar, kg/cm<sup>2</sup>, MPa and kPa.

Other measuring ranges available on request.

3-fold overload safety available on request.

### Vacuum tightness

Yes (for restrictions see overload safety)

## Output signals

| Output signals       |                  |
|----------------------|------------------|
| Current (2-wire)     | 4 ... 20 mA      |
| Voltage (3-wire)     | DC 0 ... 10 V    |
|                      | DC 0 ... 5 V     |
|                      | DC 1 ... 5 V     |
|                      | DC 0.5 ... 4.5 V |
| Ratiometric (3-wire) | DC 0.5 ... 4.5 V |

Other output signals on request

### Load in $\Omega$

Current (2-wire):  $\leq (\text{power supply} - 8 \text{ V}) / 0.02 \text{ A}$

Voltage (3-wire):  $> \text{maximum output signal} / 1 \text{ mA}$

Ratiometric (3-wire):  $> 10\text{k}$

## Voltage supply

| Output signal                | Power supply      |                               |
|------------------------------|-------------------|-------------------------------|
|                              | Standard          | Option                        |
| 4 ... 20 mA                  | DC 8 ... 30 V     | DC 8 ... 35 V <sup>1)2)</sup> |
| DC 0 ... 10 V                | DC 14 ... 30 V    | DC 14 ... 35 V                |
| DC 0 ... 5 V <sup>3)</sup>   | DC 8 ... 30 V     | DC 8 ... 35 V                 |
| DC 1 ... 5 V                 | DC 8 ... 30 V     | DC 8 ... 35 V                 |
| DC 0.5 ... 4.5 V             | DC 8 ... 30 V     | DC 8 ... 35 V                 |
| DC 0.5 ... 4.5 V ratiometric | DC 5 V $\pm$ 10 % | -                             |

1) Not possible with non-linearity 0.25 % BFSL

2) Only possible for temperatures up to 80 °C (176 °F)

3) Not possible with measuring ranges  $\leq 0.1 \text{ bar}$  (or equivalent)

The power supply for the pressure sensor must be made via an energy-limited electrical circuit in accordance with section 9.3 of UL/EN/IEC 61010-1, or an LPS per UL/EN/IEC 60950-1, or class 2 in accordance with UL1310/UL1585 (NEC or CEC). The power supply must be suitable for operation above 2,000 m should the pressure sensor be used at this altitude.

### Total current consumption

Current (2-wire): Signal current, max. 25 mA

Voltage (3-wire): 8 mA

Ratiometric (3-wire): 8 mA

## Accuracy specifications

Optionally the model A-10 is available with an improved non-linearity. Depending on the selected non-linearity the following values result:

|   | Standard                 | Option                                  |
|---|--------------------------|---|
| Non-linearity per BFSL (IEC 61298-2)                    |                          |   |
| ■ Measuring range $\leq 0.1$ bar                        | $\leq \pm 0.5$ % of span | -                                       |
| ■ Measuring range $> 0.1$ bar                           | $\leq \pm 0.5$ % of span | $\leq \pm 0.25$ % of span <sup>1)</sup> |
| Measuring deviation of the zero signal <sup>2) 3)</sup> |                          |   |
| ■ 4 ... 20 mA   | $\leq \pm 0.3$ % of span | $\leq \pm 0.2$ % of span                |
| ■ DC 0 ... 10 V   | $\leq \pm 0.5$ % of span | $\leq \pm 0.4$ % of span                |
| ■ DC 0 ... 5 V <sup>4)</sup>                            | $\leq \pm 0.6$ % of span | -                                       |
| ■ DC 1 ... 5 V  | $\leq \pm 0.3$ % of span | $\leq \pm 0.2$ % of span                |
| ■ DC 0.5 ... 4.5 V                                      | $\leq \pm 0.3$ % of span | $\leq \pm 0.2$ % of span                |
| ■ DC 0.5 ... 4.5 V ratiometric                          | $\leq \pm 0.3$ % of span | $\leq \pm 0.2$ % of span                |
| Accuracy at room temperature <sup>5)</sup>              |                          |   |
| ■ Measuring range $\geq 0.6$ bar                        | $\leq \pm 1$ % of span   | $\leq \pm 0.5$ % of span                |
| ■ Measuring range $\geq 0.4$ bar                        | $\leq \pm 1.2$ % of span | $\leq \pm 0.7$ % of span                |
| ■ Measuring range $\geq 0.25$ bar                       | $\leq \pm 1.3$ % of span | $\leq \pm 0.8$ % of span                |
| ■ Measuring range $\geq 0.16$ bar                       | $\leq \pm 1.5$ % of span | $\leq \pm 1$ % of span                  |
| ■ Measuring range $\geq 0.1$ bar                        | $\leq \pm 1.8$ % of span | -                                       |
| ■ Measuring range $\geq 0.05$ bar                       | $\leq \pm 2.4$ % of span | -                                       |

In case of occasional faults due to electrostatic discharges, a temporary measuring error of up to  $\pm 2.5$  % can occur.

1) Not possible with output signal DC 0 ... 5 V

2) Measuring ranges  $\leq 0.1$  bar (or equivalent) only possible with  $\leq \pm 0.5$  % of span.

3) Outside reference conditions the temperature hysteresis has to be added for measuring ranges  $< 0.6$  bar.

4) Not possible with measuring range  $\leq 0.1$  bar (or equivalent)

5) Including non-linearity, hysteresis, zero offset and end value deviation (corresponds to measured error per IEC 61298-2), calibrated in vertical mounting position with process connection facing downwards

### Non-repeatability (per IEC 61298-2)

Measuring range  $\leq 0.1$  bar:  $\leq 0.2$  % of span

Measuring range  $> 0.1$  bar:  $\leq 0.1$  % of span

### Signal noise

$\leq \pm 0.3$  % of span

( $\leq \pm 0.2$  % of span on request)

### Temperature error at 0 ... 80 °C (32 ... 176 °F)

Typical:  $\leq \pm 1$  % of span

Maximum:  $\leq \pm 2.5$  % of span

Maximum  $\leq \pm 1.5$  % of span on request

### Long-term drift (per IEC 61298-2)

Measuring ranges  $\leq 0.1$  bar:  $\leq \pm 0.5$  % of span <sup>1)</sup>

Measuring ranges  $\leq 0.4$  bar:  $\leq \pm 0.2$  % of span

Measuring ranges  $> 0.4$  bar:  $\leq \pm 0.1$  % of span

1) Outside reference conditions the temperature hysteresis has to be added for measuring ranges  $< 0.1$  bar.

### Temperature hysteresis -30 ... +100°C (-22 ... +212 °F) for measuring ranges $< 0.6$ bar

| Measuring range | Gauge pressure           | Absolute pressure        |
|-----------------|--------------------------|--------------------------|
| $\geq 0.40$ bar | $\leq \pm 0.2$ % of span | $\leq \pm 0.2$ % of span |
| $\geq 0.25$ bar | $\leq \pm 0.3$ % of span | $\leq \pm 0.3$ % of span |
| $\geq 0.16$ bar | $\leq \pm 0.5$ % of span | $\leq \pm 0.5$ % of span |
| $\geq 0.10$ bar | $\leq \pm 0.7$ % of span | $\leq \pm 0.8$ % of span |
| $\geq 0.05$ bar | $\leq \pm 1.4$ % of span | -                        |

## Time response

| Measuring range | Settling time        | Switch-on time |
|-----------------|----------------------|----------------|
| ≥ 0.4 bar       | < 4 ms <sup>1)</sup> | < 15 ms        |
| ≥ 0.05 bar      | < 1 min              | < 1 min        |

1) 1 ms on request

## Operating conditions

### Ingress protection (per IEC 60529)

see table "Specifications"

### Vibration resistance

10 g (IEC 60068-2-6, under resonance) <sup>1)</sup>

20 g available on request <sup>2) 3)</sup>

1) With GL approval and measuring range 0 ... 0.6 bar only feasible with an accuracy of 1 %

2) With GL approval only feasible for measuring range > 0 ... 1 bar

3) From -30 °C (-22 °F)

### Shock resistance

500 g (IEC 60068-2-27, mechanical)

100 g at -40 °C (-40 °F)

### Service life

Measuring range > 0.1 bar: 100 million load cycles

Measuring range ≤ 0.1 bar: 10 million load cycles

## Permissible temperature ranges

|         | Standard                            | Option                               |  |
|---------|-------------------------------------|--------------------------------------|--|
|         |                                     | Voltage signal                       | Current signal <sup>1) 2)</sup>                    |
| Ambient | 0 ... +80 °C<br>(32 ... 176 °F)     | -30 ... +100 °C<br>(-22 ... +212 °F) | -40 ... +100 °C <sup>3)</sup><br>(-40 ... +212 °F) |
| Medium  | 0 ... +80 °C<br>(32 ... 176 °F)     | -30 ... +100 °C<br>(-22 ... +212 °F) | -40 ... +100 °C <sup>3)</sup><br>(-40 ... +212 °F) |
| Storage | -40 ... +70 °C<br>(-40 ... +158 °F) | -40 ... +70 °C<br>(-40 ... +158 °F)  | -40 ... +70 °C<br>(-40 ... +158 °F)                |

Restrictions and derating of the ambient temperature depend on the medium temperature. Depending on the choice of sealing on the process connection, there may be limitations in the permissible temperature range (for limitations see "Process connections, sealings").

1) With cULus approval the minimum ambient and medium temperature is -30 °C (-22 °F)

2) Only with power supply DC 8 ... 30 V

3) Only with housed installation site that is protected from condensation

## Reference conditions (per IEC 61298-1)

### Temperature

15 ... 25 °C (59 ... 77 °F)

### Atmospheric pressure

860 ... 1,060 mbar (12.5 ... 15.4 psi)

### Humidity

45 ... 75 % relative

### Power supply

DC 24 V

### Mounting position

as required

## Process connections

| Standard                    | Thread size  |
|-----------------------------|--|
| EN 837                      | G 1/8 B <sup>1)</sup>                              |
|                             | G 1/4 B  |
|                             | G 1/4 female                                       |
|                             | G 1/4 female, with flange connection <sup>2)</sup> |
|                             | G 3/8 B  |
|                             | G 1/2 B  |
| DIN 3852-E <sup>3) 4)</sup> | G 1/4 A  |
|                             | G 1/2 A  |
|                             | M14 x 1.5  |
| ANSI/ASME B1.20.1           | 1/8 NPT <sup>1)</sup>                              |
|                             | 1/4 NPT  |
|                             | 1/4 NPT female                                     |
|                             | 1/2 NPT  |
| DIN 16288                   | M20 x 1.5  |
| ISO 7                       | R 1/4  |
|                             | R 3/8  |
|                             | R 1/2  |
| KS                          | PT 1/4   |
|                             | PT 1/2   |
|                             | PT 3/8   |
| SAE J514 E <sup>3) 4)</sup> | 7/16-20 UNF O-ring BOSS                            |

1) Maximum measuring range 400 bar

2) Maximum measuring range 100 bar

3) Maximum overload safety 600 bar

4) Maximum permissible temperature -20 ... +100 °C (-4 ... +212 °F)

## Pressure port

|          | Pressure port | Possible process connections |
|----------|---------------|------------------------------|
| Standard | 3.5 mm        | All                          |
| Option 1 | 0.6 mm        | All male threads             |
| Option 2 | 0.3 mm        | All male threads             |
| Option 3 | 6.0 mm        | G 1/4 A and 1/4 NPT          |

Optionally a T-restrictor is possible for the following process connections:

- G 1/4 B
- G 3/8 B
- G 1/2 B
- M20 x 1.5

## Sealings

For the process connections of the following standards the listed sealing materials are available.

| Standard   | Standard | Option          |
|------------|----------|-----------------|
| EN 837     | Copper   | Stainless steel |
| DIN 3852-E | NBR      | FKM             |
| DIN 16288  | Copper   | Stainless steel |
| SAE J514 E | NBR      | FKM             |

The sealings listed under "Standard" are included in the delivery.

# Electrical connections

| Designation                               | Ingress protection <sup>3)</sup> | Wire cross-section                | Cable diameter | Cable material |
|---|----------------------------------|-----------------------------------|----------------|----------------|
| <b>Angular connector DIN 175301-803 A</b> |                                  |                                   |                |                |
| ■ with mating connector                   | IP65                             | up to a max. 1.5 mm <sup>2</sup>  | 6 ... 8 mm     | -              |
| ■ with moulded cable                      | IP65                             | 3 x 0.75 mm <sup>2</sup>          | 6 mm           | PUR            |
| <b>Angular connector DIN 175301-803 C</b> |                                  |                                   |                |                |
| ■ with mating connector                   | IP65                             | up to a max. 0.75 mm <sup>2</sup> | 4.5 ... 6 mm   | -              |
| ■ with moulded cable                      | IP65                             | 4 x 0.5 mm <sup>2</sup>           | 6.2 mm         | PUR            |
| <b>Circular connector M12 x 1 (4-pin)</b> |                                  |                                   |                |                |
| ■ without mating connector                | IP67                             | -                                 | -              | -              |
| ■ straight with moulded cable             | IP67                             | 3 x 0.34 mm <sup>2</sup>          | 4.3 mm         | PUR            |
| ■ angled with moulded cable               | IP67                             | 3 x 0.34 mm <sup>2</sup>          | 4.3 mm         | PUR            |
| <b>Cable outlet</b>                       |                                  |                                   |                |                |
| ■ unshielded <sup>1)</sup>                | IP67                             | 3 x 0.34 mm <sup>2</sup>          | 4 mm           | PUR            |
| ■ OEM version, unshielded <sup>2)</sup>   | IP67                             | 3 x 0.14 mm <sup>2</sup>          | 2.85 mm        | TPU            |

1) Not feasible with GL approval

2) up to a max. 90 °C (194 °F)

3) The stated ingress protection (per IEC 60529) only applies when plugged in using mating connectors that have the appropriate ingress protection.

Mating connectors (with and without cable) are also separately available as accessories.  
Cable lengths of 2 m or 5 m are available.

## Short-circuit resistance

S+ vs. 0V

## Reverse polarity protection

U<sub>B</sub> vs. 0V

no reverse polarity protection with ratiometric output signal

## Insulation voltage

DC 500 V

## Connection diagrams

All connectors with moulded cable have the same colour assignment as the unshielded cable outlet.

| Angular connector DIN 175301-803 A  |                |        |        |
|---|----------------|--------|--------|
|   |                | 2-wire | 3-wire |
|  | U <sub>B</sub> | 1      | 1      |
|   | 0V             | 2      | 2      |
|   | S+             | -      | 3      |

| Cable outlet, unshielded  |                |        |        |
|---|----------------|--------|--------|
|   |                | 2-wire | 3-wire |
|  | U <sub>B</sub> | brown  | brown  |
|   | 0V             | blue   | blue   |
|   | S+             | -      | black  |

| Angular connector DIN 175301-803 C  |                |        |        |
|---|----------------|--------|--------|
|   |                | 2-wire | 3-wire |
|  | U <sub>B</sub> | 1      | 1      |
|   | 0V             | 2      | 2      |
|   | S+             | -      | 3      |

| Cable outlet, OEM version, unshielded   |                |        |        |
|---|----------------|--------|--------|
|   |                | 2-wire | 3-wire |
|  | U <sub>B</sub> | brown  | brown  |
|   | 0V             | blue   | blue   |
|   | S+             | -      | black  |

| Circular connector M12 x 1 (4-pin)  |                |        |        |
|---|----------------|--------|--------|
|   |                | 2-wire | 3-wire |
|  | U <sub>B</sub> | 1      | 1      |
|   | 0V             | 3      | 3      |
|   | S+             | -      | 4      |

## Legend

U<sub>B</sub> Positive power supply terminal  
 0V Negative power supply terminal  
 S+ Analogue output



## Materials

### Wetted parts

- < 10 bar (150 psi): Stainless steel 316L
- ≥ 10 bar (150 psi): Stainless steel 316L and PH steel
- ≤ 0 ... 25 bar (400 psi) abs.: Stainless steel 316L

### Non-wetted parts

- Stainless steel 316L
- HNBR
- PA









For sealing materials see "Process connections"

For cable materials see "Electrical connections"

### Pressure transmission medium

- < 0 ... 10 bar (150 psi) gauge: Synthetic oil
- ≤ 0 ... 25 bar (400 psi) absolute: Synthetic oil
- ≥ 0 ... 10 bar (150 psi) gauge: Dry measuring cell

## Approvals

| Logo  | Description   | Country                     |
|---|---|-----------------------------|
|    | <b>EU declaration of conformity</b><br><ul style="list-style-type: none"> <li>■ EMC directive<br/>Emission (group 1, class B) and interference immunity (industrial application)</li> <li>■ Pressure equipment directive</li> </ul> | European Community          |
|  | <b>UL <sup>1)</sup></b><br>Safety (e.g. electr. safety, overpressure, ...)  | USA and Canada              |
|  | <b>EAC</b><br><ul style="list-style-type: none"> <li>■ Electromagnetic compatibility</li> </ul>   | Eurasian Economic Community |
|  | <b>GOST</b><br>Metrology, measurement technology  | Russia                      |
|  | <b>KazInMetr</b><br>Metrology, measurement technology   | Kazakhstan                  |
|   | <b>MTSCHS</b><br>Permission for commissioning   | Kazakhstan                  |
|  | <b>BelGIM</b><br>Metrology, measurement technology  | Belarus                     |
|  | <b>UkrSEPRO</b><br>Metrology, measurement technology  | Ukraine                     |
|  | <b>Uzstandard</b><br>Metrology, measurement technology  | Uzbekistan                  |
|  | <b>DNV GL <sup>1)</sup></b><br>Ships, shipbuilding (e.g. offshore)  | Germany                     |
|   | <b>CRN</b><br>Safety (e.g. electr. safety, overpressure, ...)   | Canada                      |

1) not for measuring ranges < 0.6 bar and not for medium temperature -40 ... +100 °C (-40 ... +212 °F)

## Manufacturer's information and certifications

| Logo  | Description                              |
|---|--|
|  | China RoHS conformity<br>SJ/T 11364-2014 |

Approvals and certificates, see website

# Dimensions in mm

## Pressure sensor

with angular connector form A

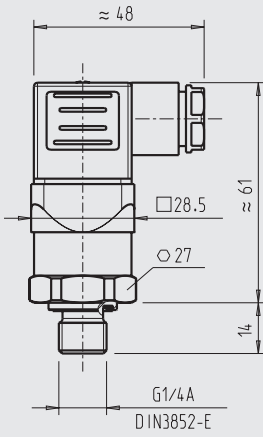

Weight: approx. 80 g

with angular connector form C

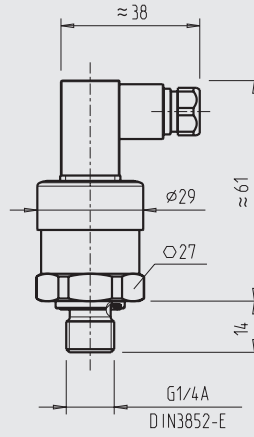

Weight: approx. 80 g

with angular connector form A and flange connection

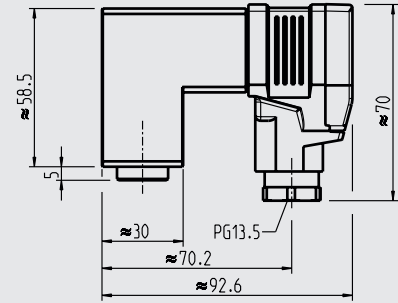

Weight: approx. 350 g

with M12 x 1 circular connector

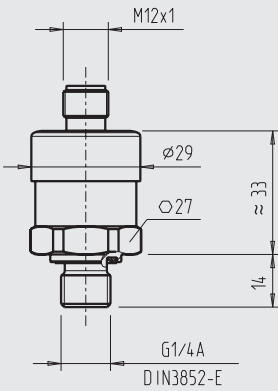

Weight: approx. 80 g

with standard cable outlet, unshielded

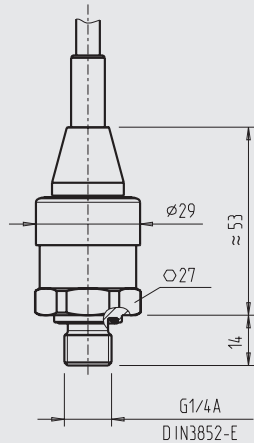

Weight: approx. 80 g

with cable outlet OEM version, unshielded

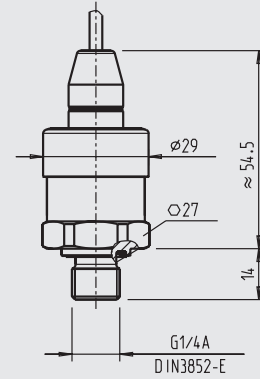

Weight: approx. 80 g

## Process connections

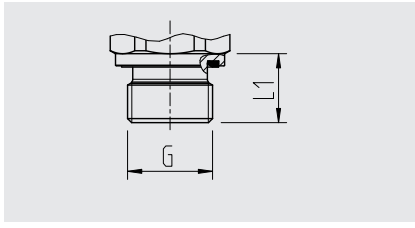

| G                  | L1 |
|--------------------|----|
| G 1/4 A DIN 3852-E | 14 |
| G 1/2 A DIN 3852-E | 17 |
| M14 x 1.5          | 14 |

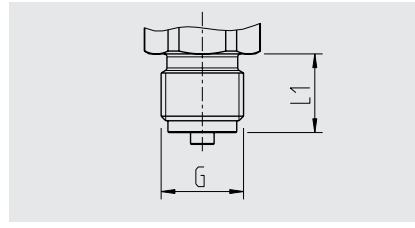

| G              | L1 |
|----------------|----|
| G 1/4 B EN 837 | 13 |
| G 3/8 B EN 837 | 16 |
| G 1/2 B EN 837 | 20 |
| M20 x 1.5      | 20 |

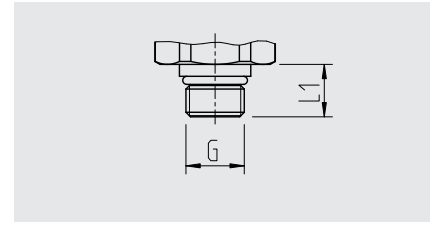

| G                | L1    |
|------------------|-------|
| 7/16-20 UNF BOSS | 12.85 |

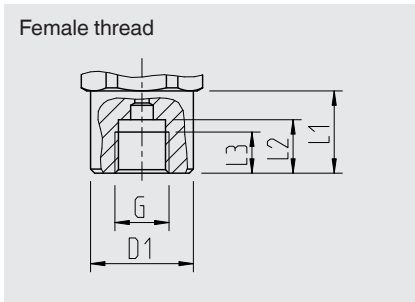

| G            | L1 | L2 | L3 | D1   |
|--------------|----|----|----|------|
| G 1/4 EN 837 | 20 | 13 | 10 | Ø 25 |

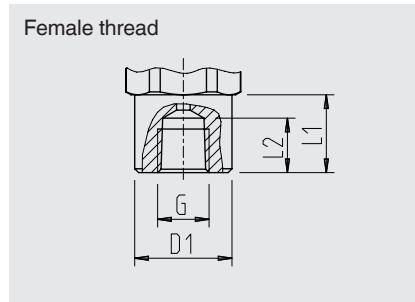

| G       | L1 | L2 | D1   |
|---------|----|----|------|
| 1/4 NPT | 20 | 14 | Ø 25 |

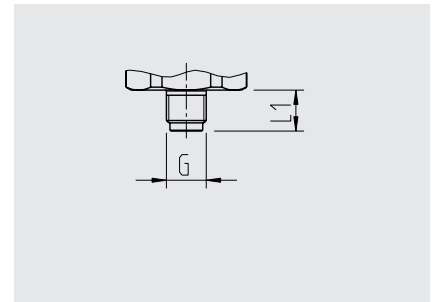

| G              | L1 |
|----------------|----|
| G 1/8 B EN 837 | 10 |

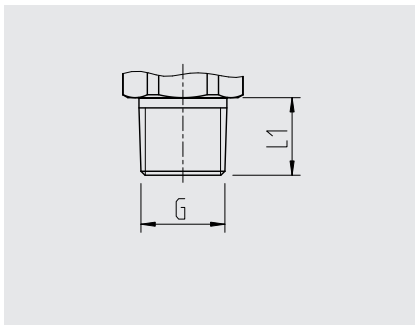

| G       | L1 |
|---------|----|
| 1/8 NPT | 10 |
| 1/4 NPT | 13 |
| 1/2 NPT | 19 |
| R 1/4   | 13 |
| R 3/8   | 15 |
| R 1/2   | 19 |
| PT 1/4  | 13 |
| PT 3/8  | 15 |
| PT 1/2  | 19 |

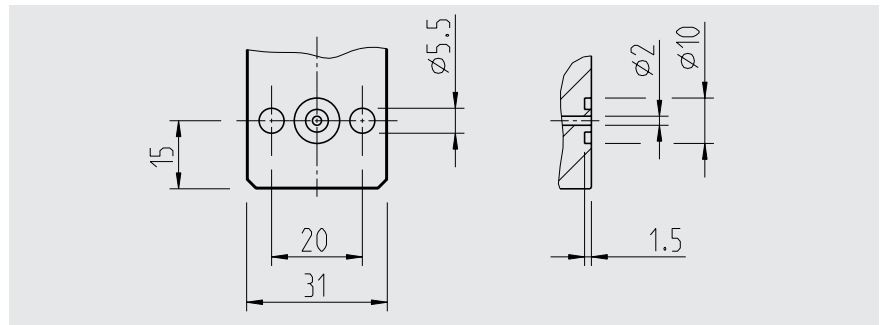

|                                      |                            |
|--------------------------------------|----------------------------|
| G 1/4 female, with flange connection | For dimensions see drawing |
|--------------------------------------|----------------------------|

For information on tapped holes and welding sockets, see Technical information IN 00.14 at [www.wika.com](http://www.wika.com)

## Accessories and spare parts

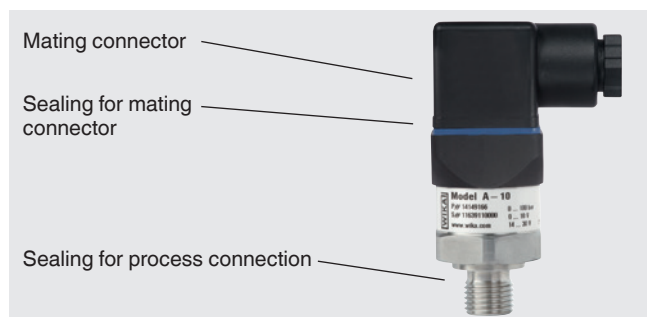

### Mating connector

| Designation                        | Order number          |                |                |
|------------------------------------|-----------------------|----------------|----------------|
|                                    | without cable         | with 2 m cable | with 5 m cable |
| Angular connector DIN 175301-803 C | 1439081 <sup>1)</sup> | 11225823       | 11250194       |
| Angular connector DIN 175301-803 A |                       |                |                |
| ■ with cable gland, metric         | 11427567              | 11225793       | 11250186       |
| ■ with cable gland, conduit        | 11022485              | -              | -              |
| Circular connector M12 x 1, 4-pin  |                       |                |                |
| ■ straight                         | 2421262               | 11250780       | 11250259       |
| ■ angled                           | 2421270               | 11250798       | 11250232       |

1) Connector not permissible for A-10 with GL approval

### Sealings for mating connectors

| Designation                        | Order number |                 |
|------------------------------------|--------------|-----------------|
|                                    | Blue (WIKA)  | Brown (neutral) |
| Angular connector DIN 175301-803 A | 1576240      | 11437902        |
| Angular connector DIN 175301-803 C | 11169479     | 11437881        |

### Sealings for process connection

| Designation    | Order number |                 |         |         |
|----------------|--------------|-----------------|---------|---------|
|                | Cu           | Stainless steel | NBR     | FKM     |
| G ¼ EN 837     | 11250810     | 11250844        | -       | -       |
| M14 x 1.5      | -            | -               | 1537857 | 1576534 |
| G ½ EN 837     | 11250861     | 11251042        | -       | -       |
| M20 x 1.5      | 11250861     | 11251042        | -       | -       |
| G ⅜ EN 837     | 11251051     | -               | -       | -       |
| G ¼ DIN 3852-E | -            | -               | 1537857 | 1576534 |
| G ½ DIN 3852-E | -            | -               | 1039067 | 1039075 |

Only use the accessories and spare parts listed, otherwise it could lead to the loss of the approval.

### Ordering information

Model / Measuring range / Output signal / Power supply / Non-linearity / Temperature range / Process connection / Sealing / Electrical connection

© 2011 WIKA Alexander Wiegand SE & Co. KG, all rights reserved.  
The specifications given in this document represent the state of engineering at the time of publishing.  
We reserve the right to make modifications to the specifications and materials.

