

**M12 MALE 0° / M8 FEMALE 90° LED**

PUR 3X0.34 GRAY, UL/CSA, drag ch 5m

Male straight – female 90°

M12 – M8, 3-pole

2× LED (PNP), (NPN) on request

Plastic housings with good resistance against chemicals and oils.

The resistance to aggressive media should be individually tested for your application. Further details on request.

Further cable lengths on request.

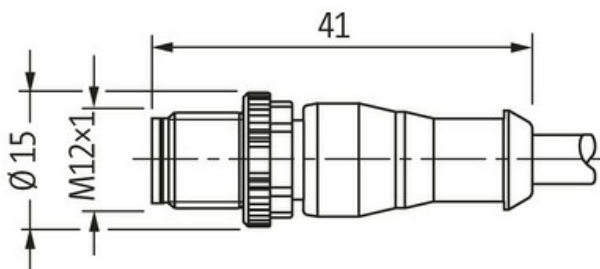
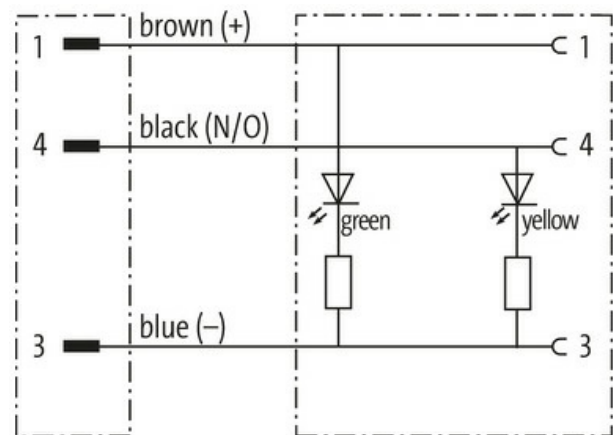
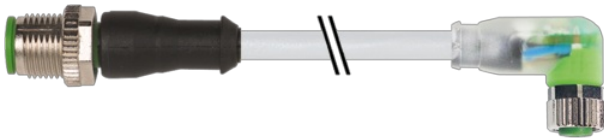
**[Link to Product](#)****Illustration**

Male

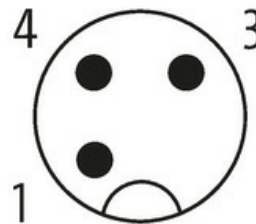

Female

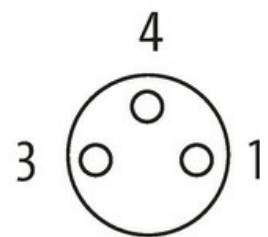

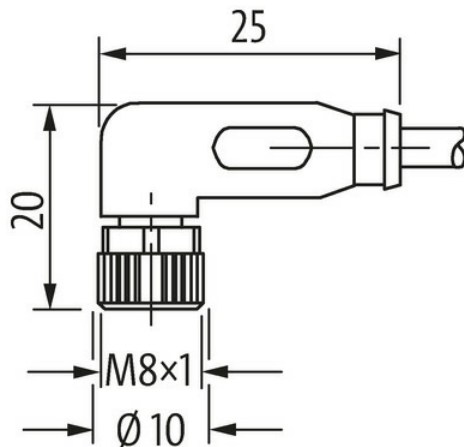

Product may differ from Image

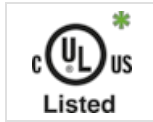

\* only for products with UL/CSA approved cable

**Form**

Form 40641

**Technical Data**

Operating voltage	24 V DC $\pm 25\%$
Operating current per contact	max. 4 A
Locking of ports	Screw thread (M8/M12 $\times 1$ mm) recommended torque 0.4/0.6 Nm, self-securing
Protection	IP66K, IP67 inserted and tightened (EN 60529)
Locking material	Zinc die casting, nickel-plated

**General data**

Temperature range -25...+85 °C, depending on cable quality

**Cables**

Cable identification	233
Cable Type	3 (PUR)
Approval (cable)	cURus (AWM-Style 20549/10493); CE conform
Cable weight [g/m]	29,7 g
Material (wire)	Cu wire, bare
Resistor (core)	max. 57 $\Omega$ /km (20 °C)
Single wire $\varnothing$ (core)	0.1 mm
Construction (core)	42 $\times$ 0.1 mm (multi-strand wire class 6)
Diameter (core)	3 $\times$ 0.34 mm <sup>2</sup>
AWG	similar to AWG 22
Material (wire isolation)	PP
Material property (wire isolation)	CFC-, halogen-, cadmium-, silicone- and lead-free
Shore hardness (wire isolation)	70 $\pm 5$ D
Wire- $\varnothing$ incl. isolation	1.25 mm $\pm 5\%$
Color/numbering of wires	br, bk, bl
Stranding combination	3 wires twisted
Shield	no
Material (jacket)	PUR
Material property (jacket)	CFC-, halogen-, cadmium-, silicone- and lead-free, matt, low-adhesion, machine easy to process, abrasion-resistant, hydrolysis and microbial resistant
Shore hardness (jacket)	90 $\pm 5$ A
Outer- $\varnothing$ (jacket)	4.1 mm $\pm 5\%$

The information in this brochure has been compiled with the utmost care.

Liability for the correctness completeness and topicality of the information is restricted to gross negligence. Version: 12/21

Color (jacket)	gray
chemical resistance	good resistance to oil, gasoline and chemicals (EN 60811-404)
thermal resistance	flame retardand UL 1581 Section 1090 (H), CSA FT2 / IEC 60332-2-2
Nominal voltage	300 V AC
Test voltage	2500 V AC
Current load capacity	to DIN VDE 0298-4
Temperature range (fixed)	-40...+80 °C, (+90 °C at max. 10 000 operating hours)
Temperature range (mobile)	-25...+80 °C, (+90 °C at max. 10 000 operating hours)
Bend radius (fixed)	5× outer Ø
Bend radius (moving)	10× outer Ø
No. of bending cycles (C-track)	max. 10 Mio. (25 °C)
Travel speed (C-track)	max. 3 m/s
Acceleration (C-track)	max. 10 m/s <sup>2</sup>
Torsion stress	±180°/m
No. of torsion cycles	max. 2 Mio. (25 °C)
Torsion speed	35 cycles/min

#### Commercial data

country of origin	DE
customs tariff number	85444290
EAN	4048879083737
eClass	27279218
Packaging unit	1.000