

Contents

Preface	1
1 Precautions	4
1.1 Safety precautions	4
1.2 Other precautions	5
2 Specifications	7
2.1 Common specifications for Hope800 series	7
2.2 Product series specifications	错误! 未定义书签。
3 Installation and wiring	12
3.1 Installation	12
3.2 Removal and installation of parts	13
3.2.1 Removal and installation of keypad	13
3.2.2 Installation of keypad on cabinet front cover	13
3.2.3 Uninstallation/Installation of Cover and Control Panel	14
3.3 Wiring	15
3.3.1 Wiring and configuration of main circuit terminals	16
3.3.2 Wiring method	20
3.3.3 Control board terminals, jumpers and wirings	20
3.4 Methods of suppressing electromagnetic interference	24
4 Operation and commissioning	27
4.1 Operation and display	27
4.1.1 Keypad functions	27
4.1.2 Display status and operation of keypad	28
4.2 Power on for the first time	30
4.3 Quick commissioning	30
4.3.1 Setting of common parameters	30
4.3.2 Quick commissioning for V/F control	31
4.3.3 Quick commissioning for vector control	31
5 Parameter table	32
F0: Basic Parameters	32
F1: Accel/decel, start, stop and jog parameters	33

F2: V/F control parameters34

F3: Speed, torque and flux control parameters36

F4: Digital input terminals and multistep speed37

F5: Digital and relay outputs39

F6: Analog and pulse frequency terminals41

F7: Process PID parameters43

F8: Simple PLC.....45

F9: Wobble frequency, counter, meter-counter and zero-servo46

FA: Motor parameters47

Fb: Protection functions and advanced settings48

FC: Keypad operation and display settings51

Fd: Expansion options and functions.....52

FE: Programmable unit54

FF: Communication parameters57

Fn: Factory parameter57

FP: Fault history.....58

FU: Data monitoring59

6 Parameter description62

6.1 F0: Basic Parameters62

6.2 F1: Accel/decel, start, stop and jog parameters.....65

6.3 F2: V/F control parameters.....70

6.4 F3: Speed, torque and flux control parameters74

6.5 F4: Digital input terminals and multistep speed.....78

6.6 F5: Digital output and relay outputs85

6.7 F6: Analog and pulse frequency terminals.....89

6.8 F7: Process PID parameters.....94

6.9 F8: Simple PLC.....98

6.10 F9: Wobble frequency, counter, meter-counter and zero-servo103

6.11 FA: Motor parameters.....108

6.12 Fb: Protection functions and advanced settings112

6.13 FC: Keypad operation and display settings.....119

6.14 Fd: Expansion options and functions.....120

6.15 FE: Programmable unit124

6.16	FF: Communication parameters	130
6.17	FP: Fault history.....	136
6.18	FU: Data monitoring	137
7	Troubleshooting	140
7.1	Faults and remedies.....	140
7.2	Alarms and remedies.....	143
7.3	Operation faults and remedies	146
8	Maintenance and after-sale services	148
8.1	Daily maintenance.....	148
8.2	Periodical maintenance.....	148
8.3	Replacement of parts	149
8.4	Storage of the inverter	149
8.5	After-sale services	149
9	Options	150
9.1	Braking unit	150
9.2	Communication component.....	150
9.3	AC reactor.....	151
9.4	EMI filter and ferrite chip common-mode filter	151
9.5	Digital I/O expansion board	151
9.6	Encoder interface board(SL-PG0).....	152
9.7	Keypad options	154
9.8	Keypad mounting box.....	156
9.9	Analog input expansion board.....	156

Preface

Thank you for purchasing our SenLan Hope800 series high-performance vector control inverters.

Hope800 is a new-generation inverter developed independently by the SenLan Science & Technology Holding Corp., Ltd., featuring low noise, high performance and multiple functions. It adopts the rotor field-oriented vector control strategy to realize high-accuracy, wide-range speed and torque control of the motor with high reliability, powerful functions. It can be widely applied in metallurgy, petroleum, chemical engineering, spinning, electric power, building materials, coal, medicine, food, papermaking, plastic, printing and dyeing, hoisting, cable, washing, water supply, heating and ventilation, sewage treatment and other industries, such as drawbenches, mixers, extruders, winding machines, compressors, fans, pumps, grinding machines, belt conveyors, hoists and centrifuges.

Hope800's wide application attributes to its modular design and various options, which offer the customers integrated solutions, lower the system cost and improve the system reliability remarkably. Furthermore, users can carry out secondary development according to their own needs.

Please carefully read and understand this manual before installing, setting, running and maintaining the product and keep it in safety. The technical specifications for the product may alter and the contents of this manual are subject to change without notice.

Check after unpacking

Please check the following items after unpacking the inverter. If there is anything missing, contact us or our distributors.

Check items	Check method
If the product is exactly what you have ordered?	Check to see if the data on the nameplate of the inverter is consistent with those in your order form
If there is any damage of the product?	Observe the external appearance of the product. Check to see if it has got any damage during transportation.

Description of inverter type

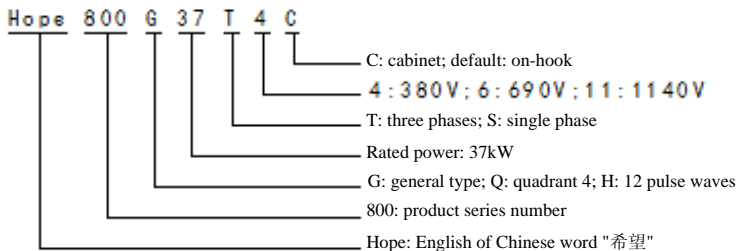

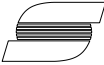

Description of Inverter Nameplate: (based on Hope800G132T4)

<h2>Slanvert Inverter</h2>	
Model: Hope800G132T4	Executive standard: GB/T12668.2
Rated input: 3 phases 380V 50/60Hz	Product No.: 1234567
Rated output: 3 phases 0~380V 0~650Hz	
Rated current: 253A	
Rated power: 132kW	
 <h1 style="margin: 0;">Slanvert</h1> <p style="margin: 0; font-size: small;">Hope Slanvert Science and Technology Corp., Ltd.</p>	

Safety signs



The safety signs in this manual fall into two categories:

 **DANGER** : indicates that errors in operation may destroy the inverter or lead to death or heavy injury to people.

 **CAUTION** : indicates that errors in operation may lead to damage to the inverter or other devices.

Terms and abbreviations:

Name	Description
AI	Analog Input, see page 79
AO	Analog Output, see page 81
ASR	Automatic Speed Regulator, see page 60
AVR	Automatic Voltage Regulation, see page 64
EMC	Electric Magnetic Compatibility
EMI	Electric Magnetic Interference
LED	Light Emitting Diode
PFI	Pulse Frequency Input, see page 82
PFO	Pulse Frequency Output, see page 82
PID	Proportion-integration – differentiation, see page 83
PG	Pulse Generator, see page 105

PWM	Pulse Width Modulate
UP/DOWN value	A percentage value that can be adjusted by terminals and keypad  /  keys. It can be used as the frequency reference (max. frequency=100%) or PID reference. See page 74
Programmable unit	A software module inside the inverter that implements the arithmetic operation, logic operation, comparison and the like. See page 109
n(digital input)	The nth digital signal listed in the “Table of digital input functions” in page 70. It can be used as the input of X, FWD and REV terminals, as well as the output of the logic unit, timer and comparator.
n (digital output)	The nth digital signal listed in the “Table of digital output functions” on page 76. It can be used as the output of the Y terminals and relays, as well as the input of the logic unit, timer, analog multi-switch, counter and meter-counter.
n (analog output)	The nth analog signal listed in the “Table of analog output functions” on page 81 It can be used as the output of the AO1, AO2 and PFO terminals, as well as the input of the comparator, analog multi-switch and low-pass filter.

1 Precautions

1.1 Safety precautions

I. Installation

- Do not install the inverter at a place with or near inflammable objects, otherwise there may be a risk of fire.
- Install the inverter on flat, smooth and solid surface and keep it away from moist, heat and condensation environment.

II. Wiring

- Make sure the high-voltage indicator is off and the DC link voltage is lower than 36V, otherwise there may be a risk of electric shock.
- Make sure that the input power is completely cut off before the wiring is conducted, otherwise there may be a risk of electric shock.
- Do not connect a braking resistor between the DC+ terminals DC- to avoid fire.
- The voltage of the input power terminals should not be out of the rated voltage range to avoid damages to the inverter.
- The grounding terminal(PE) of the inverter must be securely connected to earth (resistance to earth $\leq 10\Omega$), otherwise there may be a risk of electric fire.

III. Check before switching on the power

- Close the door of the inverter before turning on the power, otherwise there may be a risk of electric shock or explosion.
- Before trying to run the motor at a frequency over the rated motor frequency, make sure that the motor and the mechanical devices can endure such a high speed.

IV. Precautions on power and operation

- Check if parameters are appropriately set before commissioning.
- Do not open the front cover while the input power is switched on, for the high voltage inside may cause electric shock.
- Do not handle the inverter with wet hands. That may lead to electric shock.
- “Power-on auto start” is enabled before shipment from the factory. When the terminal control and the run signal are valid, the inverter will start automatically once the power is on.
- Do not control the run and stop of the inverter by switching on and off the input power.
- Related parameters should be reset after parameter initialization.
- If the function of restart has been set (such as auto-reset or restart after momentary power failure), do not approach the motor or mechanical load while the inverter is waiting to restart.

V. Precautions on transport and package

- Do not place more inverters than specified in the packaging box.
- Do not put any heavy object on the inverter.
- Do not open the cover board during transportation.
- Do not apply any force on the keypad and the cover board while handling the inverter, otherwise there may be a risk of injury to people or damage to equipment.

VI. Disposal

- Dispose the inverter as industrial waste.
- The electrolytic capacitors inside the inverter may explode while burned.
- Plastic components of the inverter will generate poisonous gases while burned.

1.2 Other precautions

I. About motor and mechanical load

- Comparison with commercial power operation

Hope800 inverter is a voltage-type PWM motor drive. Its output voltage contains some harmonics. Compared with the commercial power, it creates more loss and noise and leads to larger temperature rise of the motor.

The insulation withstands voltage of the cables and motor should be taken into account when the input voltage is high or the motor cables are long.

- Constant-torque, low-speed operation

When a common motor runs at low speed for a long time, the motor temperature will rise due to the weakened cooling effect. So if a motor is required to operate at low speed and constant torque for a long period of time, an inverter or the forced air cooling method must be applied.

- Overload protection

If the rated capacity of the motor does not match that of the inverter, regulate the overload protection level or adopt other protective measures so that the motor can operate safely.

- Running above 50Hz

If you plan to run the motor over 50Hz, be aware that the vibration and noise will increase and make sure that the motor bearings and mechanical devices can withstand such a high speed.

- Lubrication of mechanical devices

While running at low speed for a long time, such mechanical devices as gearbox and gears may be damaged due to weakened lubricating effect. Before you run them, check the lubrication conditions.

- Load of regulative torque

Regulative torque often occurs while a load is hoisted, and the inverter often stops due to overvoltage protection. In this case, an appropriate braking unit should be installed.

- Mechanical resonant point

Certain output frequencies of the inverter may be the mechanical resonant points. To avoid these points, place anti-vibration rubber under the base of the motor or setting the jump frequencies.

- Motor insulation check before connected to the inverter

When the motor is used for the first time or reused after it has not been used for a long time, the motor insulation must be inspected to prevent the damage to the inverter caused by the failed insulation of the motor windings. Use a 500V voltage-type megaohm meter to measure the insulation resistance, which should be no less than 5M Ω .

II. About inverter

- Capacitor or voltage-dependent resistor for power factor improvement

1 Precautions

As the inverter output is of PWM voltage type, the capacitor or voltage-dependent resistor (for improving the power factor) installed on the output side of the inverter will lead to inverter trip or damage to components. Do remove the capacitor or the voltage-dependent resistor before using the inverter.

■ Installation of switching devices (e.g. contactor) on inverter output side

If a switching device like contactor is required to be installed between the inverter and the motor, make sure the on/off operation is performed while the inverter has no output, otherwise the inverter may be destroyed.

■ Frequent start and stop

For applications where frequent start and stop are needed, terminals are recommended for the control of the start/stop of the inverter. Using the switching device (such as contactor) on the inverter input side to start or stop the inverter frequently is prohibited. That may destroy the inverter.

■ Using the inverter beyond the rated value

It is not recommended to operate the inverter beyond the range of the allowable input voltage. If the inverter has to be used beyond the range, raise or reduce the voltage via a voltage regulator.

■ Lightning protection

With the built-in protection of overvoltage from lightning, the inverter has certain self-protection ability against lightning strike.

■ Leakage protector

The high-speed switching operation during the running of the inverter will generate high-frequency current which sometimes causes the mis-operation of the leakage protection circuit. To address this issue, moderately lower the carrier frequency, shorten the wires or install a leakage protector.

Observe the following points while installing the leakage protector.

- 1) The leakage protector should be installed on the inverter input side, preferably behind the air switch (non-fuse circuit breaker).
- 2) The leakage protector should be one that is insensitive to higher harmonics or specially designed for the inverter (sensitivity above 30mA). If a common leakage protector is selected, its sensitivity and action time should be greater than 200mA and 0.2s respectively.

■ Derating of inverter

- 1) If the ambient temperature exceeds 40°C, the inverter should be derated as per figure 1 and external forced cooling should be provided.
- 2) If the altitude is above 1000 meters, heat dissipation effect of the inverter will be poor due to thin air thus it should be derated, with derated output and input current value shown in figure B and C;
- 3) If the carrier frequency is greater than the factory setting, the inverter should be derated by 5% for every 1kHz increase.

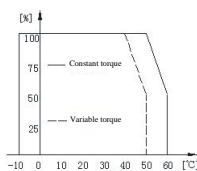

Fig. A

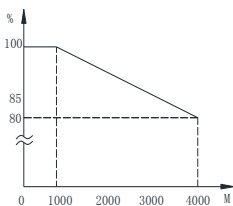

Fig. B

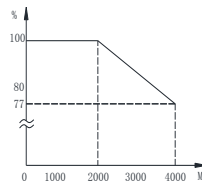

Fig. C

2 Specifications

2.1 Common specifications for Hope800 series

Item		Description
Input	Rated voltage and frequency	3 phases: 380v; 50/60Hz
	Allowable range	Voltage fluctuation range: $\pm 15\%$; voltage unbalance: $<3\%$; frequency: 47~63 Hz
Output	Output voltage	3-phase, 0V~input voltage, with the error less than 5%.
	Output frequency range	V/F control: 0.00~650.00Hz Vector control: 0.00~200.00Hz
Basic specifications	Motor control mode	V/F control without PG, V/F control with PG, vector control without PG, vector control with PG, V/F separate control
	Steady-state speed precision	Vector control without PG: $\leq 1\%$ Vector control with PG: $\leq 0.02\%$
	Starting torque	Not less than 150% of rated torque at 0.50Hz
	Overload capacity	150% of rated current for 1 minute
	Frequency resolution	Digital reference: 0.01Hz Analog reference: 0.1% of max. frequency
	Output frequency precision	Analog reference: $\pm 0.2\%$ of max. frequency(25 $\pm 10^{\circ}\text{C}$) Digital reference: 0.01Hz(-10~+40 $^{\circ}\text{C}$)
	Command source	Keypad, terminal and communication. They can be switched over by terminals
	Frequency reference source	Keypad, communication, UP/DOWN value, AI1, AI2, PFI and arithmetic unit
	Auxiliary frequency reference	Achieves flexible frequency setting
	Torque boost	Auto or manual torque boost
	V/F curve	User defined V/F, linear V/F and 5 reduced-torque curves
	Accel/decel	Linear or S-curve acceleration/deceleration
	Jog	Jog frequency: 0.10~50.00Hz Jog accel/decel time: 0.1~60.0s
	Auto energy saving	V/F curve is optimized automatically based on the load condition, achieving auto energy-saving run
	AVR	Keeps the output voltage constant automatically when the voltage of power grid fluctuates
	Auto carrier regulation	Carrier frequency is regulated automatically based on the load characteristic and ambient temperature
	Random PWM	Regulates the tone of the motor noise
	Droop control	Applicable to cases where multiple inverters drive the same load
	Momentary power failure	Ensures uninterrupted operation by controlling the DC link voltage
	DC braking	Braking time: 0.0~60.0s Braking current: 0.0~100.0% of rated current
	PFI	Highest input frequency: 50kHz
	PFO	Open-collector pulse(square wave) output of 0~50kHz, programmable
	Analog input	2 channels of analog input, voltage or current type, positive or negative
Analog output	2 channels of analog output, 0/4~20mA or 0/2~10V, programmable	
Digital input	8 channels of optional multi-function digital input(leakage/source	

2 Specifications

Item		Description
		type)
	Digital output	2 channels of optional multi-function digital output(leakage/source type); 2 channels of multi-function relay output
	Communication	Built-in RS485 port, supporting Modbus protocol and USS commands
Characteristic functions	Process PID	Two sets of PID parameters; multiple correction modes; free PID function
	Multiple PLC modes	User can set 8 PLC run modes, with each having up to 48 stages. The mode can be selected by terminals. PLC status can be saved at power failure.
	Multi-speed select mode	4 selection modes. Refer to F4-17
	User defined menu	30 user parameters can be defined
	Parameter display change	Can display parameters different from the default ones
	Torque control	Torque/speed control can be switched by terminals. Multiple torque setting modes.
	Zero-servo	Zero-speed position can be locked
Characteristic functions	High-speed UP/DOWN counter	Synchronous control, counting in production, stop control by count and precise position control can be realized
	High-speed meter counter	Stop control by length and length indication can be achieved
	Wobble	Ensures even winding of textiles
	Programmable unit	Comparator, logic unit, trigger, arithmetic unit, filter, multiple-way switch, timer
	kWh meter timer	For adjustment of optimal energy saving strategy
Protection functions		Overcurrent, overvoltage, undervoltage, input/output phase loss, output short-circuit, overheating, motor overload, external fault, analog input disconnection, stall prevention, etc.
Options		Braking unit, remote control box, digital I/O expansion board, encoder interface board, analog input expansion board, keypad with copying function or potentiometer, keypad mounting box, keypad extension line, I/O reactor, EMI filter, Profibus-DP module, etc.
Ambient	Service site	Altitude less than 1000 meters; indoor; no direct sunlight; free of dust, corrosive gases, inflammable gases, oil mist, water vapor, water drops, salt mist, etc.
	Temperature/humid	-10~+40℃/20~90%RH, no condensation
	Storage temperature	-20~+60℃
	Vibration	Less than 5.9m/s ² (0.6g)
Structure	Protection degree	IP30
	Cooling method	Forced air cooling, with fan control

2.2 Product series specifications

Table of rated value of inverter:

Model	Rated capacity (kVA)	Rated output current (A)	Adapted motor (kW)	Model	Rated capacity (kVA)	Rated output current(A)	Adapted motor (kW)
Hope800G0.4T4	1.1	1.5	0.4	Hope800 G45T4	60	91	45
Hope800G0.75T4	1.6	2.5	0.75	Hope800G55T4	74	112	55
Hope800G1.5T4	2.4	3.7	1.5	Hope800G75T4	99	150	75
Hope800G2.2T4	3.6	5.5	2.2	Hope800G90T4	116	176	90
Hope800G4T4	6.4	9.7	4	Hope800G110T4	138	210	110
Hope800G5.5T4	8.5	13	5.5	Hope800G132 T4	167	253	132
Hope800G7.5T4	12	18	7.5	Hope800G160 T4	200	304	160
Hope800G11T4	16	24	11	Hope800G200 T4	248	377	200
Hope800G15T4	20	30	15	Hope800G220T4	273	415	220
Hope800G18.5T4	25	38	18.5	Hope800G250T4	310	475	250
Hope800G22T4	30	45	22	Hope800G280T4	342	520	280
Hope800G30T4	40	60	30	Hope800G315T4	389	590	315
Hope800G37T4	49	75	37	Hope800G375T4	460	705	375

2 Specifications

Outline and installation dimensions of HOPE800G0.4~15T4 are as follow:

Model	W(mm)	W1(mm)	H(mm)	H1(mm)	H2(mm)	d(mm)	Φ(mm)	Weight (kg)
Hope 800G0.4T4	100	87.5	180	170	5	157	4.5	2
Hope800G0.75T4								
Hope800G1.5T4								
Hope800G2.2T4	135	125	240	230	5	170	4.5	3
Hope800G4T4								
Hope800G5.5T4	150	138	300	288	6	195	5.5	7
Hope800G7.5T4								
Hope800G11T4	200	185	380	367	6	225	7	10
Hope800G15T4								

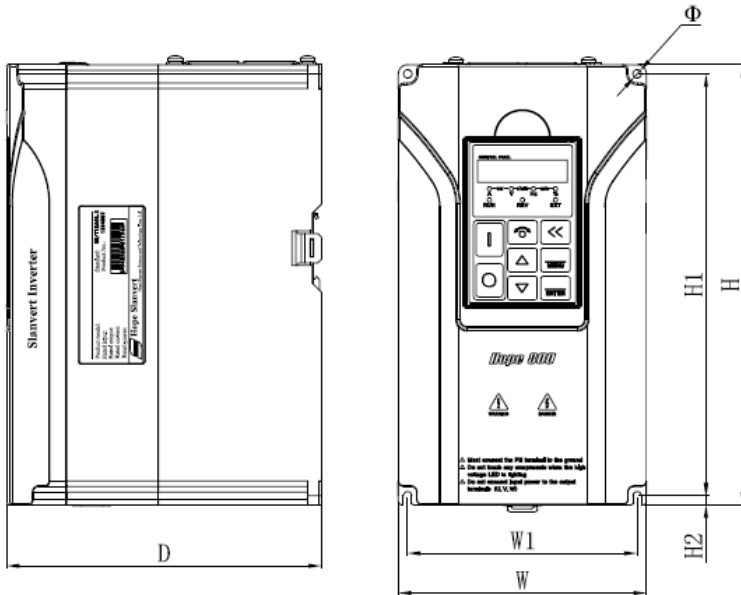

Outside dimension of Hope800G10.4~15T4

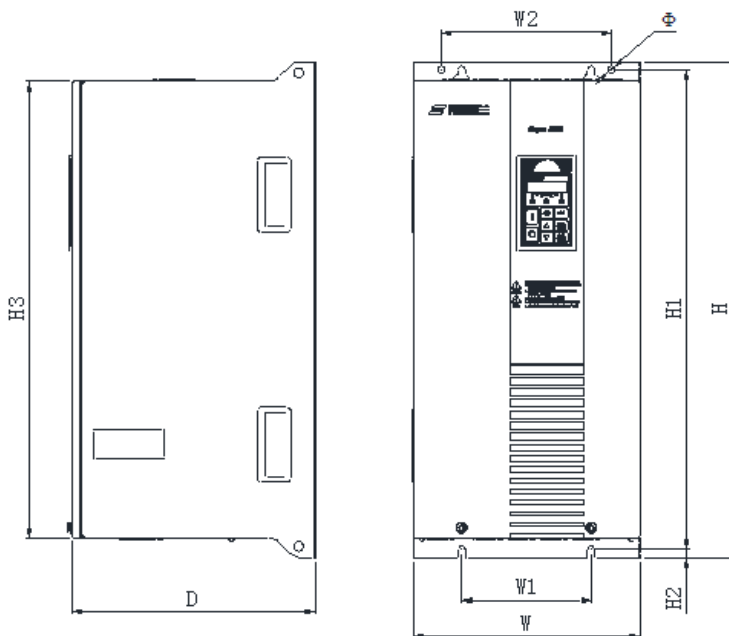

Outside dimension of Hope800G18.5~375T4:

Model	W (mm)	W1 (mm)	W2 (mm)	H (mm)	H1 (mm)	H2 (mm)	H3 (mm)	D(mm)	Φ(mm)	Weight (kg)
Hope800G18.5T4	275	160	200	530	515	7	490	285	7	22
Hope800G22T4										
Hope800G30T4										
Hope800G37T4	280	160	210	625	605	10	575	300	9	35
Hope800G45T4										
Hope800G55T4										
Hope800G75T4	305	200	240	800	780	10	750	350	9	47
Hope800G90T4										
Hope800G110T4										
Hope800G132T4	360	260	300	960	935	10	905	375	11	80
Hope800G160T4										
Hope800G200T4										
Hope800G220T4	500	300	400	1260	1235	10	1205	385	11	82
Hope800G250T4										
Hope800G280T4										
Hope800G315T4	650	400	500	1350	1320	13	1280	385	13	175
Hope800G375T4										
										180
										200
										220

3 Installation and wiring

3 Installation and wiring

3.1 Installation

	<ol style="list-style-type: none">1. The installation of the inverter can be performed only by qualified professionals.2. Do not install and run the inverter if there is any damage on the inverter or any part is missing, otherwise there may be a risk of fire and injury.3. Install the inverter on a firm support that can bear its weight, otherwise the inverter may fall and cause damage or injury.4. Do not apply force on the keypad or cover board while handling the inverter, otherwise the falling of keypad or cover board may cause damage or injury.
---	--

The inverter should be installed in a room with good ventilation. The installing environment should meet the following requirements:

1. Ambient temperature: $-10\sim 40^{\circ}\text{C}$. If the temperature exceeds 40°C , derate the inverter by 5% for every one-degree increase in temperature and apply external forced cooling.
2. Altitude: not greater than 1000m. If the altitude exceeds 1000m, derate the inverter by 1% for every 100-meter increase in altitude.
3. Humidity: less than 90% RH, no condensation.
4. Vibration: less than 5.9m/s^2 (0.6g)
5. Avoid installing it at a place with direct sunlight
6. Avoid installing it at a place with much dust and metal powder
7. Never install it at a place with corrosive and inflammable gases
8. The inverter should be installed vertically instead of upside down, slantways or horizontally, and fixed to a firm structure with screws. Installation, installation space and distance requirements are shown in the figure below:

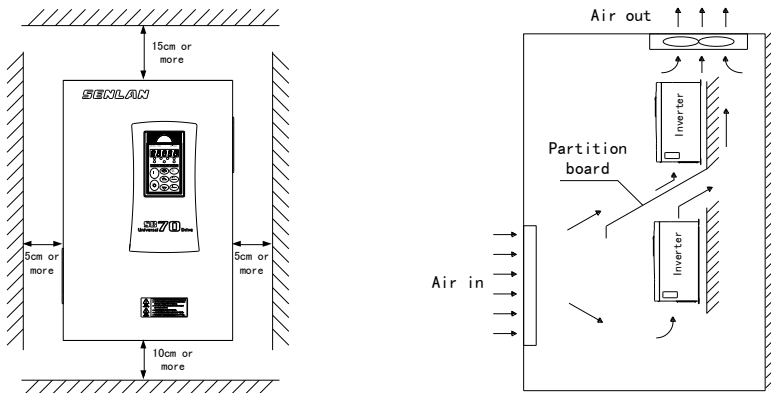

3 Installation and wiring

3.2 Removal and installation of parts

3.2.1 Removal and installation of keypad

Removal: press the spring piece on top of the keypad and pull out.

Installation: push the keypad in with the slot on its bottom aligning with the stopper on the mounting box.

Press the spring piece and pull out

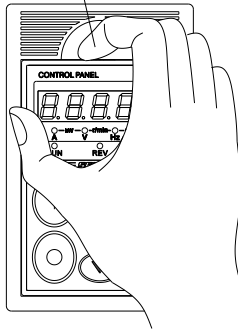

Installation of keypad

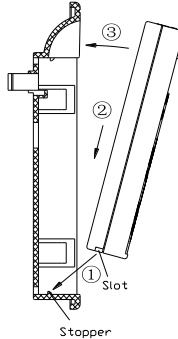

3.2.2 Installation of keypad on cabinet front cover

The keypad of a Hope800 inverter can be taken off from the inverter and installed on the front cover of the cabinet, with the keypad and inverter connected by the extension line. You can choose any one of the following two installing methods.

◆ Method 1: direct installation

- ① Make an opening on the front cover of the cabinet according to the following drawing.
- ② Take off the keypad and the two screws on the diagonal of the keypad. Fix the keypad to the front cover with the two M3×14 screws shipped with the product.
- ③ Insert one end of the extension line into the keypad and fix it with the fastener shipped with the product. Insert the other end of the extension line into the corresponding slot on the inverter circuit board and lock it. Close the cover board of the cabinet.

Holes for installing keypad

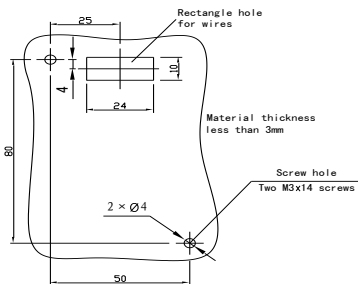

Holder T/SL-23 (accessory) prevents the extension line connector coming off from the keypad

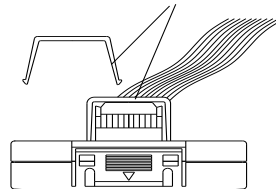

3 Installation and wiring

◆ Method 2: installation via the mounting box

- ① Make an opening on the front cover of the cabinet according to the following drawing.
- ② Install the mounting box (option) onto the front cover.
- ③ Install the keypad into the mounting box.
- ④ Insert one end of the extension line into the keypad and the other end into the corresponding slot on the inverter circuit board, and lock the line. Close the cover board of the cabinet.

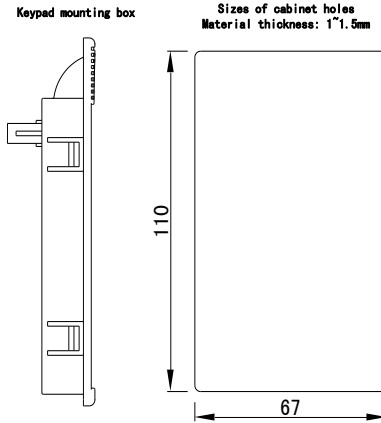

3.2.3. Uninstallation/Installation of Cover and Control Panel

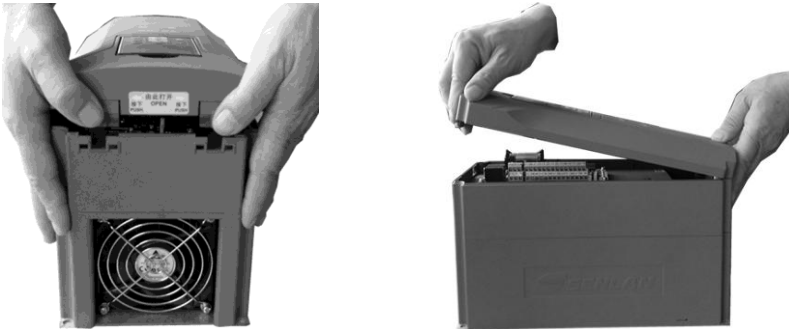

During uninstallation, disassemble keypad and press the two buckles on the top of cabinet simultaneously with two hands as shown in the left figure to take cover board down with slight upward force.

During installation, align hook at the bottom of cover board to cabinet slot and press cover board top downward by taking bottom as pivot till hook on top enters slot; finally, install keypad as per the figure above.

The bottom, rather than shell of the product, can be held when transporting;

3 Installation and wiring

3.3 Wiring



1. **Wiring of the inverter can be performed only by qualified professionals.**
2. **Before opening the cover board of the inverter, cut the power supply and wait for at least five minutes after all indicators on the keypad go out.**
3. **The wiring inside the inverter can only begin after the internal high-voltage indicator of the inverter goes out or the voltage between terminals DC+ and DC- (measured with voltmeter) is less than 36V.**
4. **The inverter must be earthed reliably, otherwise there may be a risk of electric shock or fire.**
5. **Shorting DC+ and DC- is prohibited. That may cause fire or damage to properties.**
6. **Connecting the power line with U, V or W is prohibited.**
7. **The inverter has passed the voltage resistance test before it is shipped from the factory; the users need not do this test again.**
8. **Major loop terminals and conductor cold-pressed terminal shall be firmly connected. Attachment DC electric reactor shall be installed if power is over 90kW.**
9. **All terminals must be securely connected.**
10. **Connecting surge absorbing capacitors or voltage-dependent resistors on the output side of the inverter is prohibited.**

3 Installation and wiring

3.3.1 Wiring and configuration of main circuit terminals

The inverter and its peripherals are connected as follows:

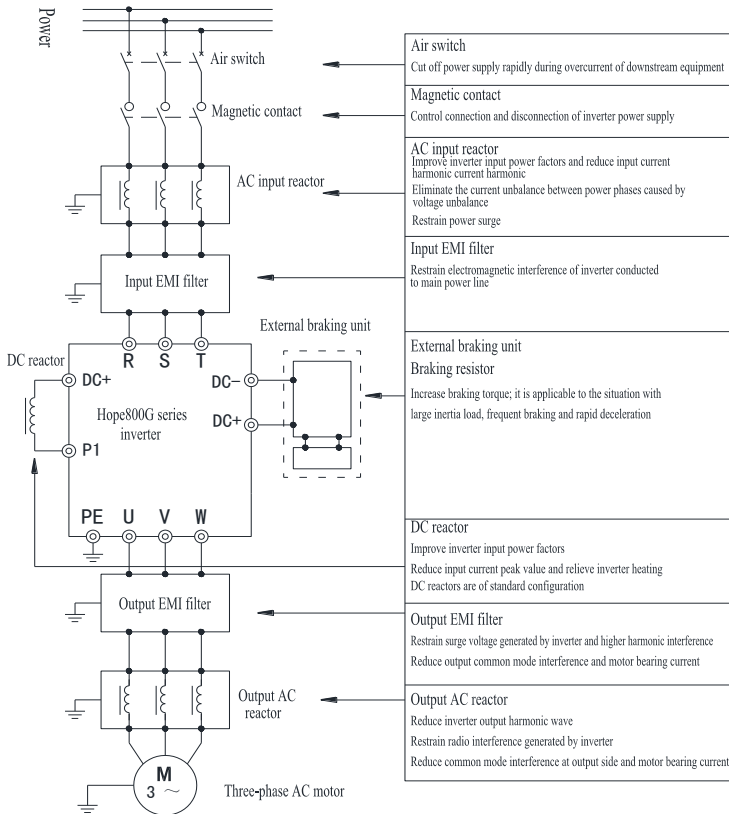

We recommend you to choose the following air switches and main circuit wirings (copper-core insulation wires):

Inverter model	Aire switch (A)	Main circuit wiring (mm ²)	AWG	Bolt dimension	Torque value	Wiring lug
Hope800G0.4~1.5T4	16	2.5	12	M3	2N.m	IT2.5-2
Hope800G2.2~4T4	20	4	10	M3	2N.m	IT4-3
Hope800G5.5~7.5T4	40	6	8	M4	3N.m	UT6-5
Hope800G11~15T4	63	8	6	M5	5N.m	UT10-6
Hope800G18.5~22T4	100	10	4	M8	10N.m	DT-16
Hope800G30T4	125	16	3	M8	10N.m	DT-25
Hope800G37T4	160	25	1	M8	10N.m	DT-25

3 Installation and wiring

Inverter model	Aire switch (A)	Main circuit wiring (mm ²)	AWG	Bolt dimension	Torque value	Wiring lug
Hope800G45T4	200	35	1	M8	10N.m	DT-35
Hope800G55T4	200	35	1	M8	10N.m	DT-35
Hope800G75T4	315	70	2/0	M8	10N.m	DT-70
Hope800G90T4	315	70	2/0	M10	22.5N.m	DT-70
Hope800G110T4	400	95	4/0	M10	22.5N.m	DT-95
Hope800G132T4	400	95	4/0	M10	22.5N.m	DT-95
Hope800G160T4	500	70*2	(1/0)*2	M12*2	38N.m	(DT-70)*2
Hope800G200T4	630	95*2	(4/0)*2	M12*2	38N.m	(DT-95)*2
Hope800G220T4	630	120*2	(250kcmil)*2	M12*2	38N.m	(DT-120)*2
Hope800G250~280T4	850	120*2	(250kcmil)*2	M12*2	38N.m	(DT-120)*2
Hope800G315T4	1000	150*2	(300kcmil)*2	M12*2	38N.m	(DT-150)*2
Hope800G375T4	1200	150*2	(300kcmil)*2	M12*2	38N.m	(DT-150)*2

Basic wiring diagram is shown as below:

3 Installation and wiring

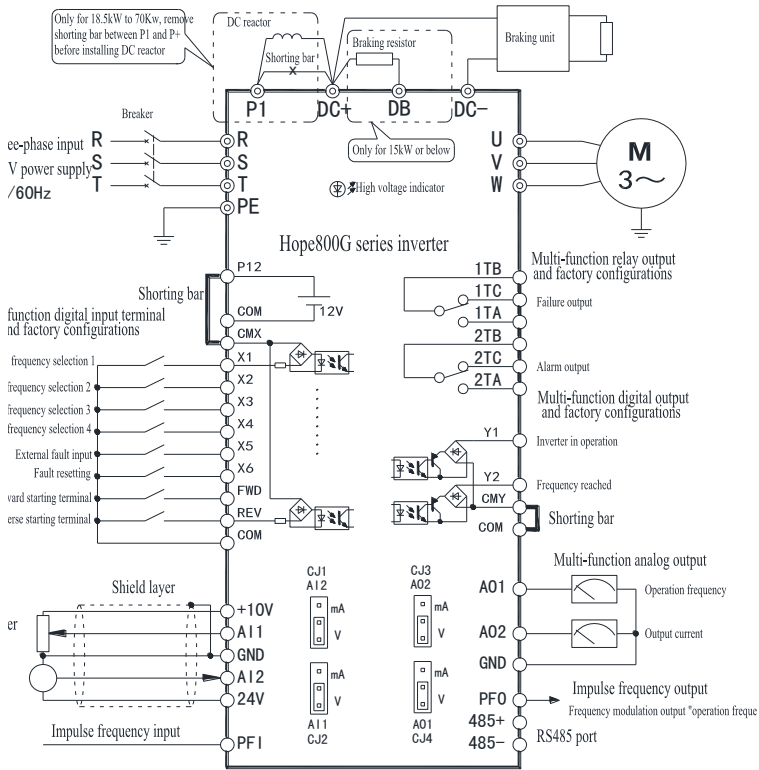

Description of main circuit terminals:

Symbol	Terminal name	Description
R, S, T	Power input terminal	To 3-phase 380V power supply
U, V, W	Inverter output terminal	To 3-phase motor
P1, DC+	DC reactor terminal	Connect an external DC reactor(shorted by a bar if reactor is not used)
DC+, DC-	DC bus terminal	Connect a braking unit, common DC bus or external rectifying unit. Contact us for the usage of the common DC bus.
PE	Grounding terminal	Connect the inverter case to earth.

Arrangement of main circuit terminals:

Hope800G0.4T4~Hope800G 15T4 (PE is located at the bottom right corner of the bottom board)



Hope800G18.5T4~Hope800G375T4:

3 Installation and wiring



Each connection terminal of Hope800G160~375 includes upper main connection terminal and lower auxiliary connection terminal, and user shall employ main connection terminal for wiring as per the figure below:

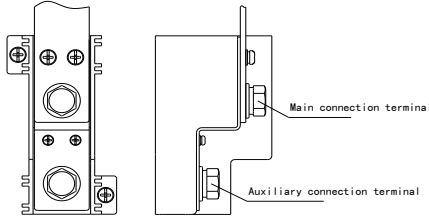

Arrangement of main circuit terminal of cabinet shall be subject to real product.

To prevent the mutual coupling generating disturbance, the control cables, power cables and motor cables must be laid apart as far as possible, especially when the cables are run in parallel to a long distance. If the control cables must cross the power ones, run them at right angles.

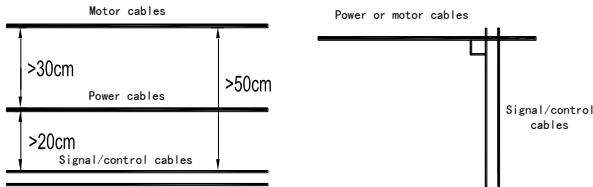

The longer the motor cables or the larger the section area of motor cables, the larger the ground capacitance, and the stronger the mutual coupling and disturbance. Therefore, the cables with specified section area and minimum length should be used.

Hope800 series inverter above 75kW is equipped with built-in air blower fault detect software, which is capable of automatically inspecting operation conditions of air blower; recommended grounding methods:

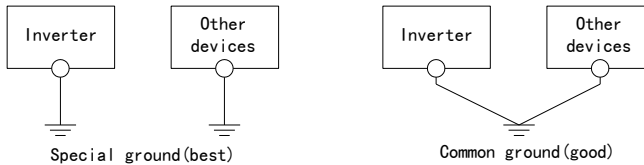

Incorrect grounding methods:

3 Installation and wiring

Arrangement of Hope800 series control board terminals (1mm²copper wires recommended as the terminals wirings):

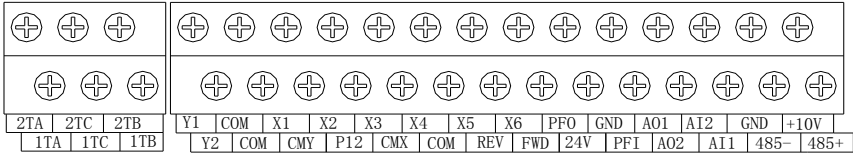

Functions of Hope800 series control board terminals:

Symbol	Name	Function and description	Specification
485+	485 differential signal (positive)	RS485 communication port	Connect 1~32 RS485 station(s) Input impedance: > 10kΩ
485-	485 differential signal (negative)		
GND	Ground	Grounding terminal for analog I/O, PFI, PFO, communication, +10V or 24V power	Its inside is isolated from COM, CMX and CMY
+10V	+10V reference power supply	+10V power supply offered to user	Max. output current is 15mA, with the voltage accuracy better than 2%
PFO	Pulse frequency output	Refer to F6-25	0~50 kHz, open collector output Specification: 24V/50mA
PFI	Pulse frequency input	Refer to F6-22~24	0~50 kHz, with input impedance of 1.5 kΩ High level: > 6V Low level: < 3V Max. input voltage: 30V
AO1	Multi-function analog output 1	Refer to F6-14 and F6-18 Jumpers CJ4 and CJ3 are used to select the output type(voltage or current type)	Current type: 0~20mA, load ≤ 500Ω Voltage type: 0~10V, output ≤ 10mA
AO2	Multi-function analog output 2		
24V	24V power terminal	24V power supply offered to user	Max. output current: 80mA
AI1	Analog input 1	Refer to F6-00 and F6-07 Jumpers CJ1 and CJ2 are used to select the output type(voltage or current type)	Input voltage: - 10~+10V Input current: - 20~+20mA Input impedance: 110kΩ for voltage input, 250Ω for current input
AI2	Analog input 2		
Symbol	Name	Function and description	Specification
X1	X1 digital input terminal	Refer to F4	Opto-isolation Bi-directional input available Input impedance: ≥3kΩ Input voltage: < 30V Sampling period: 1ms High level: voltage difference (relative to CMX) greater than 10V
X2	X2 digital input terminal		
X3	X3 digital input terminal		
X4	X4 digital input terminal		

3 Installation and wiring

Symbol	Name	Function and description	Specification
X5	X5 digital input terminal		Low level: voltage difference (relative to CMX) less than 3V
X6	X6 digital input terminal		
REV	REV digital input terminal		
FWD	FWD digital input terminal		
CMX	Digital input common terminal	Common terminal for X1~X6, FWD and REV	Its inside is isolated from COM and P12. CMX and its adjacent P12 are shorted before shipment from the factory.
P12	12V power terminal	12V power supply offered to user	Max. output current: 80mA (12V)
COM		Ground of 12V power	
Y1	Y1 digital output terminal	Refer to F5	Opto-isolated, bi-directional, open collector output Specification: 24V DC/50mA Action frequency: <500Hz Start-up voltage: <2.5V(relative to CMY) CMY and COM are shorted before shipment from the factory.
Y2	Y2 digital output terminal		
CMY	Common terminal of Y1 and Y2	Common terminal of Y1 and Y2 digital output	
1TA	Relay 1 output terminal	Refer to F5	TA-TB: normally open TB-TC: normally closed Contacts: 250V AC/3A 24V DC/5A
1TB			
1TC			
2TA	Relay 2 output terminal		
2TB			
2TC			

1) Wiring of analog input terminals

When analog signals are used for remote control, the control wires between the controller and inverter should be less than 30 meters in length. And since the analog signal is vulnerable to interference, the analog control wires should be laid apart from strong-electricity, relay or contactor circuit. The wiring should be shielded twisted pair cable and be as short as possible, with one of its end connected to the terminal GND of the inverter.

2) Wiring of multi-function input(X1~X6, FWD, REV) and output (Y1, Y2) terminals

Hope800 has two types of logic for its multi-function input and output terminals: leakage and source. Therefore, the interfacing is easy and flexible. The typical connections for multi-function input and output terminals are shown below:

3 Installation and wiring

Connection of multi-function input terminals to peripherals

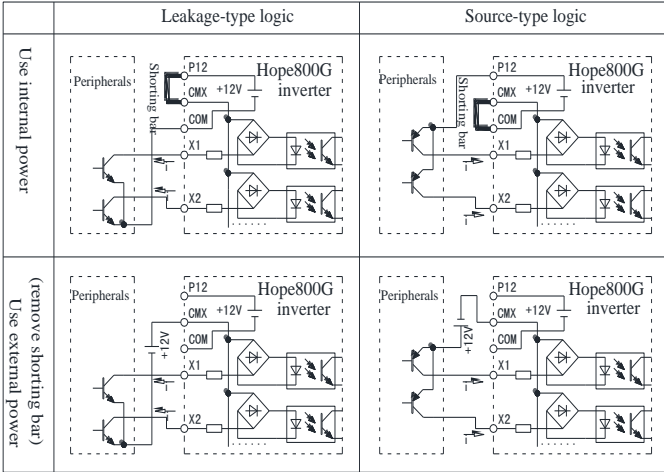

3 Installation and wiring

Connection of multi-function output terminals to peripherals

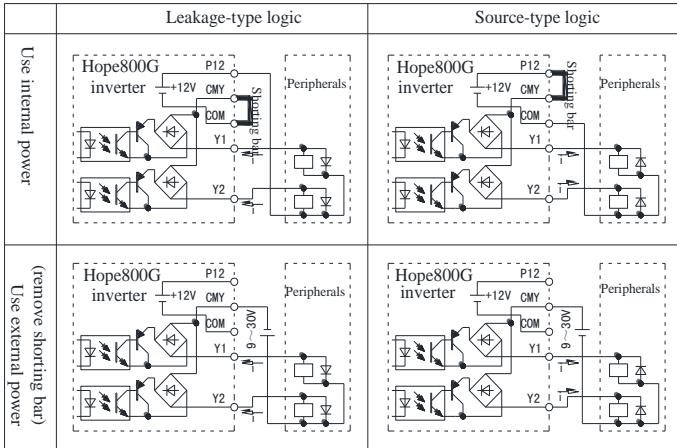

3) Wiring of relay output terminals(TA, TB, TC)

If an inductive load, such as an electromagnetic relay, contactor and electromagnetic brake, is driven, a surge voltage absorbing circuit, voltage-dependent resistor or continuous current diode (used in DC electromagnetic circuit. Be careful of the polarity during installation) should be installed. The components of the absorbing circuit should be installed near the sides of the winding of the relay or contactor, as shown below.

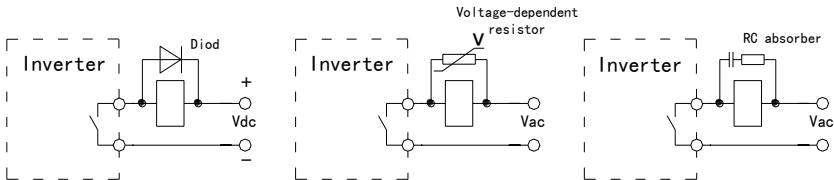

3.4 Methods of suppressing electromagnetic interference

Working principle of inverter decides that a certain of interference will be generated, which may cause (electro magnetic compatibility) problems for equipment or system. As an electronic equipment, the inverter also will be influenced by external electromagnetic interference. Installation and design methods meeting EMC codes are introduced below for the reference of field installation and wiring.

3 Installation and wiring

1. Countermeasures against electromagnetic interference

Interference source	Countermeasure
Leakage current Ground loop	When peripheral devices form a closed circuit through the wiring of the inverter, the leakage current from the earthing line of the inverter will cause false action of devices. To reduce false action, you may leave devices unearthed.
Power cables	When peripheral devices share the same power supply with the inverter, the interference generated by the inverter will transmit along the power line, causing false action of other devices in the same system. Following measures can be taken: (1) Install an EMI filter or ferrite common-mode filter (magnetic ring) on the input side of the inverter. (2) Isolate noise of other devices with an isolation transformer or power supply filter.
Motor cable radiation Power cable radiation Inverter radiation	As measuring meters, radios, sensors or signal lines are installed in the same cabinet with the inverter, they are easy to be interfered with and act falsely. Following measures can be taken: (1) Install devices and signal lines which are easily affected as far as possible away from the inverter. The signal lines should be shielded wires and be earthed. They should be run in metal conduits, and be as far as possible away from the inverter and its input/output lines. If the signal lines have to cross the power cables, keep them at right angles. (2) Install an EMI filter or ferrite common-mode filter (magnetic ring) on both input and output side of the inverter. (3) Motor cables should be laid in a thick shield, such as conduits (over 2mm) or cement tubes. The power cables should be run in metal conduits and be shielded and earthed(the motor cable is a 4-core cable, one end of which is connected to earth one the inverter side, while the other end is connected to the motor case).
Static induction Electromagnetic induction	(1) Avoid running signal lines in parallel with or in the same bundle with the power cables. (2) Try to keep devices and signal lines subject to disturbance as far as possible away from the inverter and its input and output lines. (3) Use shield wires as the signal lines and power cables and lay them in separate metal conduits, with the space between the two conduits being at least 20cm.

2. Countermeasures against leakage current

Leakage current is generated due to the existence of capacitance between inverter input/output cables and earth, between lines and between the motor and earth. The size of the leakage current, including earth leakage current and inter-line leakage current, is determined by the size of the distributed capacitance and carrier frequency.

Sources of leakage current:

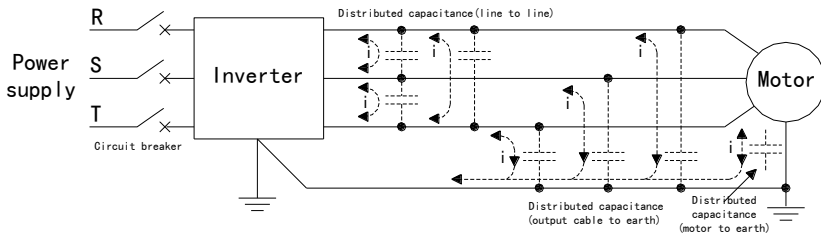

3 Installation and wiring

Earth leakage current

The leakage current may flow into not only the inverter system, but also other devices via the earth line, causing false action of the leakage circuit breaker, relay or other devices. The higher the carrier frequency and the longer the motor cables, the larger the leakage current.

Suppression measures: (1) Lower the carrier frequency, but that will increase the motor noise; (2) Minimize the length of the motor cables; (3) Use a leakage circuit breaker specially designed for higher harmonics and surge leakage current.

Inter-line leakage current

The higher harmonics of the leakage current from the inter-line distributed capacitance on the inverter output side may lead to false action of the external thermal relay, especially when the inverter has a small capacity and the wiring is very long (over 50m). Therefore we recommend you to use a temperature sensor to monitor the motor temperature directly or use the inverter's motor overload protection function to replace the external thermal relay.

Suppression measures: (1) Lower the carrier frequency; (2) Install a reactor on the output side.

4 Operation and commissioning

4.1 Operation and display

4.1.1 Keypad Functions

The keypad is used to set or browse parameters, control operations, display error information and so on. It has a standard configuration SB-PU800 and four optional configurations SB-PU03 (with potentiometer keypad) and SB-PU70E (with copying function), SB-PU04 (with LCD keypad) and SB-PU05 (with encoder keypad). The appearance of the keypad is as follows.

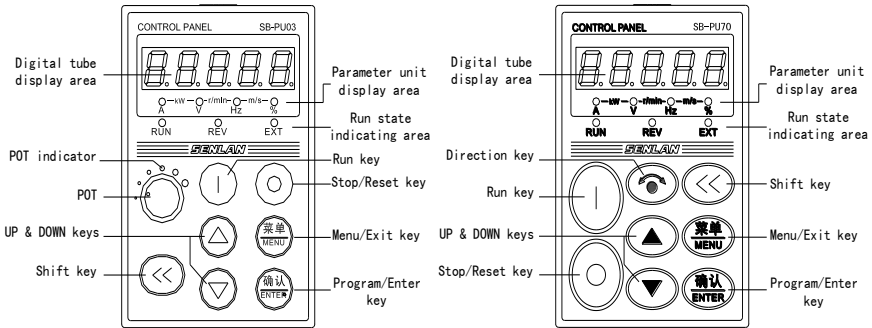

Description of SB-PU800 keys on the keypad:

Key	Name	Function
	Menu/Exit	Return to previous menu; enter/exit monitoring status
	Enter	Enter next menu; save parameter; clear alarm information
	UP	Increasing number or data
	DOWN	Decrease number or data
	Shift	Select the data digit to be modified; switch between monitored parameters
	Direction	Set run direction. This key is invalid if the hundreds digit of FC-01 is set to 0.
	Run	Run command
	Stop/Reset	Stop, fault reset

Meanings of unit indicators:

Indicators	Unit	Description
\bullet A — kW — \circ V — r/min — \circ Hz — m/s — \circ %	A	Ampere
\circ A — kW — \bullet V — r/min — \circ Hz — m/s — \circ %	V	Volt
\circ A — kW — \circ V — r/min — \bullet Hz — m/s — \circ %	Hz	Hertz
\circ A — kW — \circ V — r/min — \circ Hz — m/s — \bullet %	%	Percent
\bullet A — kW — \bullet V — r/min — \circ Hz — m/s — \circ %	kW	Kilowatt (indicators A and V are on)
\circ A — kW — \bullet V — r/min — \bullet Hz — m/s — \circ %	r/min	Revolution/minute (indicators V and Hz are on)
\circ A — kW — \circ V — r/min — \bullet Hz — m/s — \bullet %	m/s	Meter/second (indicators Hz and % are on)
\bullet A — kW — \bullet V — r/min — \bullet Hz — m/s — \circ %	Length	Meter or millimeter (indicators A, V and Hz are on)
\circ A — kW — \bullet V — r/min — \bullet Hz — m/s — \bullet %	Time	Hour, minute, second or millisecond (indicators V, Hz and % are on)

Meanings of status indicators RUN, REV and EXT:

Indicator	Status	Inverter state
RUN indicator	Off	Standby state
	On	Stable run state
	Blinking	Accelerating or decelerating state
REV indicator	Off	Both preset and current direction are forward
	ON	Both preset and current direction are reverse
	Blinking	Preset direction is inconsistent with current direction
EXT indicator	Off	Keypad control
	ON	Terminal control
	Blinking	Communication control
Potentiometer indicator	ON	Indicator is on when F0-01=10

4.1.2 Display status and operation of keypad



The keypad of Hope800 has the following display status: monitoring status (including in standby state and in run state), parameter editing status, fault display status, alarm display status, etc.

When FC-00=1, the user parameters are not under the password protection, but modifying FC-00 needs the user password.

Fault display status

Once the inverter detects a fault signal, the keypad enters the fault display status, and the error code blinks. The fault can be reset by inputting reset command ( key, control terminal or communication command). If the fault still exists, the error code continues to blink, during this period you can modify related parameters to eliminate the fault.

Alarm display status

When the inverter detects the alarm information, the alarm code blinks. If there are multiple alarm signals, the alarm codes display alternately. The alarm information can be temporarily hidden by pressing  or  . The alarm signal is automatically removed if normal state is recovered. The inverter does not stop in alarm display status.

Other display status

Display information	Description
UP	Parameters are being uploaded
dn	Parameters are being downloaded
CP	Parameters are being compared
Ld	Default values are being recovered
yES	Parameters compared are consistent

4.2 Power on for the first time

Connect the wires in accordance with the technical requirements specified in section 3.3.

After checking the wiring and power supply, close the air switch of the AC power on the inverter input side. “8.8.8.8” will first be displayed on the keypad of the inverter. When the contactor inside the inverter is closed normally, the display becomes the reference frequency. This shows the inverter initialization has been completed. If anything unusual occurs when the power is turned on, disconnect the air switch and check and remove the error.

4.3 Quick commissioning

General and necessary commissioning steps for speed control of Hope800 series inverter in general mode are given in this Section.

4.3.1 Setting of common parameters

1. Control mode: select the control mode according to the application conditions and requirements. Refer to F0-12 in page 64;
2. Frequency setting channel and reference frequency: refer to F0-01 in page 62;
3. Command source: refer to F0-02 in page 62;

4. Maximum frequency, upper-limit frequency and lower-limit frequency: refer to F0-07 and F0-08 in page 64;
5. Motor run direction: refer to F0-09 in page 64;
6. Accel/decel time: the accel/decel time should be as long as possible. Too short time will cause overcurrent or overlarge torque which damages the load.
7. Start and stop mode: refer to F1-19 in page 66 and F1-25 in page 67;
8. Motor nameplate parameters: rated power, motor pole number, rated current, rated frequency, rated speed and rated voltage. Refer to page 110;
9. Motor overload protection: refer to Fb-00, Fb-01 and Fb-02 in page 112.

4.3.2 Quick commissioning for V/F control

The method of quick commissioning for V/F control without PG is described below. For V/F control with PG, the encoder-related parameters need to be set, too, refer to page 105.

1. V/F curve setting: refer to page 70;
2. Torque boost selection: refer to page 70;
3. Motor auto tuning: refer to FA-00 in page 110. For V/F control, just set FA-00 to 11(standstill auto-tuning).

Optimization of V/F control:

1. F2-09 is used to eliminate the vibration when the motor drives a light load. If vibration occurs, increase the value of F2-09 gradually until the vibration disappears.
2. If the current at the start is too large, reduce the value of F2-02.
3. It is recommended to boost the torque automatically (F2-01=2) in order to increase the inverter's starting torque and its output torque at low speeds. To use the function of "auto torque boost", the motor nameplate parameters need to be set appropriately and the motor standstill auto-tuning be performed.
4. Slip compensation can ease the speed drop caused by the load. It is only valid when "auto torque boost" is valid. Parameters of F2-05 and F2-06 need to be set. And F2-07 and F2-08 can be set, too.

4.3.3 Quick commissioning for vector control

The method of quick commissioning for vector control without PG is as follows. For vector control with PG, the encoder-related parameters need to be set, too, refer to page 105.

1. Adjust the parameter F3-22, making the motor no-load current at low speeds (non flux-weakening region) under vector control approximately equal the motor no-load current. Refer to page 77;
2. The motor auto-tuning (without load) needs to be performed for vector control. If it is impossible to perform it, the motor parameters must be manually input, including FA-08, FA-09, FA-10 and FA-11.;
3. Setting of the speed regulator: refer to page 74.
4. During vector control, F2-12 shall be set in same way as FA-04.

5 Parameter table

Note: In the “Change” column of the table below, “O” indicates the parameter can be changed in any state, “×” indicates the parameter is only changeable in running state, while “△” indicates the parameter is read only.

F0: Basic Parameters

No.	Name	Setting range	Default	Change	Page
F0-00	Digital reference frequency	0.00Hz~F0-06	50.00Hz	○	62
F0-01	Main reference channel	0: F0-00 2: UP/DOWN value 4: AI2 7: Arithmetic unit 2 9: Arithmetic unit 4 1: Communication 3: AI1 6: Arithmetic unit 1 8: Arithmetic unit 3 10: Keypad POT	0	○	62
F0-02	Command source	0: Keypad Communication 1: Terminal 2:	0	×	62
F0-03	Frequency holding	Units digit: selects the frequency saving mode after power failure. 0: Frequency changed via Δ , \odot or communication is stored in F0-00. 1: Frequency changed via Δ , \odot or communication is not stored. Tens digit: selects the frequency holding mode in stop state. 0: Frequency changed via Δ , Δ or communication is retained. 1: Frequency changed via Δ , Δ or communication is restored to F0-00.	00	○	62
F0-04	Auxiliary reference channel	0: None 2: UP/DOWN value 4: AI2 6: Arithmetic unit 1 8: Arithmetic unit 3 1: F0-00 3: AI1 5: PFI 7: Arithmetic unit 2 9: Arithmetic unit 4	0	○	63
F0-05	Auxiliary reference gain	-1.000~1.000	1.000	○	63
F0-06	Max. frequency	F0-07~650.00Hz(V/F)/200.00Hz (vector control)	50.00Hz	×	63
F0-07	Upper-limit frequency	F0-08 “lower frequency” ~F0-06 “maximum frequency”	50.00Hz	×	63
F0-08	Lower-limit frequency	0.00Hz~F0-07 “lower frequency”	0.00 Hz	×	63
F0-09	Direction lock	0: Forward or reverse 1: Forward only 2: Reverse only	0	○	63
F0-10	Parameter protection	0: No protection 1: Except F0-00 and F7-04 2: Full protection	0	○	63

No.	Name	Setting range	Default	Change	Page
F0-11	Parameter initialization	11: Enabled 22: Enabled(except communication parameters)	00	×	63
F0-12	Motor control mode	0: V/F control without PG 1: V/F control with PG 2: Vector control without PG 3: Vector control with PG 4: V/F separate control	0	×	64
F0-13	Inverter rated capacity	Minimum unit: 0.01kW/0.1kW	Depends on model	△	65
F0-14	Software version	0.00~99.99	Depends on version	△	65
F0-15	User password	0000~9999 (0000 means no password)	0000	○	65

F1: Accel/decel, start, stop and jog parameters

No.	Name	Setting range	Default	Change	Page
F1-00	Accel time 1	0.01~3600.0s Acceleration time: time period over which the frequency rises by 50Hz. Deceleration time: time period over which the frequency drops by 50Hz.	Depends on model	○	65
F1-01	Decel time 1				65
F1-02	Accel time 2				65
F1-03	Decel time 2				65
F1-04	Accel time 3				65
F1-05	Decel time 3				65
F1-06	Accel time 4				65
F1-07	Decel time 4				65
F1-08	Accel time 5				65
F1-09	Decel time 5				65
F1-10	Accel time 6				65
F1-11	Decel time 6				65
F1-12	Accel time 7				65
F1-13	Decel time 7				65
F1-14	Accel time 8				65
F1-15	Decel time 8	65			
F1-16	Accel/decel minimum unit	0: 0.01s 1: 0.1s	1	○	65
F1-17	Accel/decel time auto switching point	0.00~650.00Hz(switched to accel/decel time 8 below this point)	0.00Hz	×	66
F1-18	Decel time for emergency stop	0.01~3600.0s. Minimum unit is determined by F1-16.	10.0s	○	66
F1-19	Starting mode	0: Start from starting frequency 1: Start from starting frequency after DC braking 2: Start from searched speed	0	×	66
F1-20	Starting frequency	0.00~60.00Hz	0.50Hz	○	66
F1-21	Starting frequency duration	0.0~60.0s	0.0s	○	66

5 Parameter table

F1-22	Voltage soft start	0: Disable 1: Enabled	1	×	66
F1-23	DC braking time(at start)	0.0~60.0s	0.0s	○	66
F1-24	DC braking current(at start)	0.0~100.0%(inverter rated current=100%)	0.0%	○	66
F1-25	Stop mode	0: Slowdown stop 1: Coast stop 2: Slowdown+DC braking 3: Slowdown+holding brake delay	0	○	67
F1-26	DC braking frequency (at stop)	0.00~60.00Hz	0.50Hz	○	67
F1-27	DC braking waiting time (at stop)	0.00~10.00s	0.00s	○	67
F1-28	DC braking time(at stop)	0.0~60.0s(also as the holding brake delay time)	0.0s	○	67
F1-29	DC braking current(at stop)	0.0~100.0%(inverter rated current=100%)	0.0%	○	67
F1-30	Zero-speed delay time	0.0~60.0s	0.0s	○	68
F1-31	Accel/decel mode	0: Linear 1: S-curve	0	×	68
F1-32	S-curve accel start-stage time	0.01~10.00s	0.20s	×	68
F1-33	S-curve accel end-stage time				68
No.	Name	Setting range	Default	Change	Page
F1-34	S-curve decel start-stage time	0.01~10.00s	0.20s	×	68
F1-35	S-curve decel end-stage time				
F1-36	Deadband time	0.0~3600.0s	0.0s	×	69
F1-37	Jog frequency	0.10~50.00Hz	5.00Hz	○	69
F1-38	Jog accel time	0.1~60.0s	Depends on model	○	69
F1-39	Jog decel time	0.1~60.0s	Depends on model	○	69

F2: V/F control parameters

No.	Name	Setting range	Default	Change	Page
F2-00	V/F curve	0: Self-defined 1: Linear 2: Reduced-torque V/F curve 1 3: Reduced-torque V/F curve 2 4: Reduced-torque V/F curve 3 5: Reduced-torque V/F curve 4 6: Reduced-torque V/F curve 5	1	×	70
F2-01	Torque boost	0: No boost 1: Manual 2: Auto 3: Manual+auto	1	×	70
F2-02	Manual torque boost level	0.0%~maximum value(depends on model). Minimum unit is 0.1%	Depends on model	○	70
F2-03	Manual torque boost cut-off point	0.0~100.0%(F2-12=100%)	50.0%	○	70

No.	Name	Setting range	Default	Change	Page
F2-04	Auto torque boost level	0.0~100.0%	80.0%	×	70
F2-05	Slip compensation gain	0.0~300.0%	0.0%	○	71
F2-06	Slip compensation filtering time	0.1~25.0s	1.0s	×	71
F2-07	Electromotive slip compensation limit	0~250%(motor rated slip frequency=100%)	200%	×	71
F2-08	Regenerative slip compensation limit	0~250%(motor rated slip frequency=100%)	200%	×	71
F2-09	Vibration damping	0~200	Depends on model	○	71
F2-10	AVR	0: Inactive 1: Active 2: Active except during decel	1	×	72
F2-11	Auto energy-saving operation	0: Inactive 1: Active	0	○	72
F2-12	Base frequency	1.00~650.00Hz	50.00Hz	×	72
F2-13	Max. output voltage	150~500V, default 380V	380V	×	72
F2-14	V/F frequency F4	F2-16~F2-12	0.00Hz	×	72
F2-15	V/F voltage V4	F2-17~100.0% (F2-13=100%)	0.0%	×	72
F2-16	V/F frequency F3	F2-18~F2-14	0.00Hz	×	73
F2-17	V/F voltage V3	F2-19~F2-15 (F2-13=100%)	0.0%	×	73
F2-18	V/F frequency F2	F2-20~F2-16	0.00Hz	×	73
F2-19	V/F voltage V2	F2-21~F2-17 (F2-13=100%)	0.0%	×	73
F2-20	V/F frequency F1	0.00Hz~F2-18	0.00Hz	×	73
F2-21	V/F voltage V1	0.0%~F2-19 (F2-13=100%)	0.0%	×	73

No.	Name	Setting range	Default	Change	Page
F2-22	V/F separate voltage input	0: F2-23 1: AI1 2: AI2 3: UP/DOWN value 4: PFI 5: Arithmetic unit 1 6: Arithmetic unit 2 7: Arithmetic unit 3 8: Arithmetic unit 4	0	×	74
F2-23	V/F separate voltage digital setting	0.0~100.0%	100.0%	○	74
F2-24	V/F voltage factor	0: 100.0% 1: AI1 2: AI2 3: UP/DOWN value 4: PFI 5: Arithmetic unit 1 6: Arithmetic unit 2 7: Arithmetic unit 3 8: Arithmetic unit 4	0	×	74

F3: Speed, torque and flux control parameters

No.	Name	Setting range	Default	Change	Page
F3-00	High-speed ASR proportional gain	0.00~200.00	5.00	×	74
F3-01	High-speed ASR integral time	0.010~30.000s	1.000s	×	74
F3-02	Low-speed ASR proportional gain	0.00~200.00	10.00	×	74
F3-03	Low-speed ASR integral time	0.010~30.000s	0.500s	×	74
F3-04	ASR parameter switching point	0.00~650.00Hz	0.00Hz	×	74
F3-05	ASR filtering time	0.000~2.000s	0.010s	×	74
F3-06	Accel compensation differential time	0.000~20.000s	0.000s	×	74
F3-07	Torque limit select	0: Determined by F3-08 and F3-09 1: AI1 ×2.5 2: AI2 ×2.5 3: Arithmetic unit 1 ×2.5 4: Arithmetic unit 2 ×2.5 5: Arithmetic unit 3 ×2.5 6: Arithmetic unit 4 ×2.5	0	×	74
F3-08	Electromotive torque limit	0.0~290.0%(motor rated torque=100%) Note: used for vector control only	180.0%	×	74
F3-09	Regenerative torque limit		180.0%	×	75
F3-10	ASR output frequency limit	0.0~20.0%. Used for PG V/F control only.	10.0%	×	75
F3-11	Droop level	0.00~50.00Hz	0.00Hz	○	76
F3-12	Droop starting torque	0.0~100.0%(motor rated torque=100%)	0.0%	○	76
F3-13	Torque control select	0: Conditionally active(selected by digital input 45) 1: Active	0	×	77

No.	Name	Setting range	Default	Change	Page
F3-14	Torque reference select	0: F3-15 1: AI1×2.5 2: AI2×2.5 3: PFI×2.5 4: UP/DOWN value×2.5 5: Arithmetic unit 1×2.5 6: Arithmetic unit 2×2.5 7: Arithmetic unit 3×2.5 8: Arithmetic unit 4×2.5	0	×	77
F3-15	Digital torque reference	-290.0~290.0%(motor rated torque=100%)	0.0%	○	77
F3-16	Torque control speed limit input select	0: Determined by reference frequency 1: Determined by F3-17 and F3-18	0	○	77
F3-17	Torque control speed forward limit	0.00Hz~F0-07	5.00Hz	○	77
F3-18	Torque control speed reverse limit	0.00Hz~F0-07	5.00 Hz	○	77
F3-19	Torque reference UP/DOWN time	0.000~10.000s	0.020s	×	77
F3-20	Speed/torque control swithing delay time	0.001~1.000s	0.050s	×	77
F3-21	Pre-excitation time	0.01~5.00s	Depends on model	×	77
F3-22	Flux density	50.0~150.0%	90.0%	×	77
F3-23	Low-speed flux boost	0~50%	0%	×	78
F3-24	Flux-weakening regulator integral time	0.010~3.000s	0.150s	×	78
F3-25	Electromotive power limit	0.0~250.0%(inverter rated power=100%)	120.0%	×	78
F3-26	Regenerative power limit	0.0~250.0%(inverter rated power=100%)	120.0%	×	78

F4: Digital input terminals and multistep speed

No.	Name	Setting range	Default	Change	Page
F4-00	X1 terminal	0: No signal 1: Multistep frequency 1	1		
F4-01	X2 terminal	2: Multistep frequency 3: Multistep frequency 3 4: Multistep frequency 4	2		
F4-02	X3 terminal	5: Multistep frequency 5 6: Multistep frequency 6	3	×	78
F4-03	X4 terminal	7: Multistep frequency 7 8: Multistep frequency 8	4		
F4-04	X5 terminal	9: Accel/decel time select 1 31: PLC mode select 7 32: Auxiliary reference disabled 33: Operation interrupted 34: DC braking(at stop) 35: Process PID disabled 36: PID 2 37: 3-wire stop command 38: Internal virtual FWD terminal 39: Internal virtual REV terminal 40: Analog reference frequency hold 41: Accel/decel disabled 42: Run command switched to terminal/keypad 43: Reference frequency	12		

5 Parameter table

No.	Name	Setting range	Default	Change	Page	
F4-05	X6 terminal	10: Accel/decel time switched to A11 select 2 11: Accel/decel time select 3	44: Reference frequency switched to arithmetic unit 1	13		
F4-06	FWD terminal	12: External fault input 13: Fault reset 14: Jog forward 15: Jog reverse 16: Emergency stop 17: Inverter run disabled 18: Coast stop 19: UP/DOWN increase 20: UP/DOWN decrease 21: UP/DOWN clear 22: PLC control disabled 23: PLC operation pause 24: PLC standby state reset 25: PLC mode select 1 26: PLC mode select 2 27: PLC mode select 3 28: PLC mode select 4 29: PLC mode select 5 30: PLC mode select 6	45: Speed/torque control select 46: Multi-PID select 1 47: Multi-PID select 2 48: Multi-PID select 3 49: Zero-servo command 50: Counter preset 51: Counter clear 52: Meter-counter clear 53: Wobble frequency injection 54: Wobble state reset 55: total air blower operation time reset 56: PFI position reverse 57: motor rated current select 1 58: motor rated current select 2	38		
F4-07	REV terminal			39		
F4-08	FWD/REV mode	0: 1-wire mode(start/stop) 1: 2-wire mode 1(FWD, REV) 2: 2-wire mode 2(start/stop, direction) 3: 2-wire mode 3(start, stop) 4: 3-wire mode 1(FWD, REV, stop) 5: 3-wire mode 2(run, direction, stop)		1	×	81
F4-09	Input terminal logic 1(positive & negative)	Ten thousands digit: X5 Thousands digit: X4 Hundreds digit: X3 Tens digit: X2 Units digit: X1		00000	×	83
F4-10	Input terminal logic 2(positive & negative)	Hundreds digit: REV Tens digit: FWD Units digit: X6		000	×	83
F4-11	Digital input terminal anti-jittering time	0~2000ms		10ms	○	83
F4-12	UP/DOWN regulation mode	0: Level type(terminal) type(terminal) 1: Pulse 2: Level type(keypad) 3: Pulse type(keypad)		0	○	83
F4-13	UP/DOWN speed/step	0.01~100.00(unit is %/s or %)		1.00	○	83
F4-14	UP/DOWN memory select	0: Stored on power loss 1: Cleared on power loss 2: Cleared at stop and on power loss		0	○	83
F4-15	UP/DOWN upper limit	0.0~100.0%		100.0%	○	83
F4-16	UP/DOWN lower limit	-100.0~0.0%		0.0%	○	83

No.	Name	Setting range	Default	Change	Page
F4-17	Multi-speed select mode	0: Binary code 1: Direct select 2: Sum 3: Number	0	×	84
F4-18 ~ F4-65	Multistep frequencies 1~48	0.00~650.00Hz Note: The default values of multistep frequencies 1~48 are their respective frequency code numbers, for example, the default value of the multistep frequency 3 is 3.00Hz.	n.00Hz (n=1~48)	○	84

Multistep frequencies 1~48 corresponds to F4-18~F4-65 respectively, as shown below:

n	1	2	3	4	5	6	7	8	9	10	11	12	13	14	15	16
Multi-step frequency n	F4-18	F4-19	F4-20	F4-21	F4-22	F4-23	F4-24	F4-25	F4-26	F4-27	F4-28	F4-29	F4-30	F4-31	F4-32	F4-33
n	17	18	19	20	21	22	23	24	25	26	27	28	29	30	31	32
Multi-step frequency n	F4-34	F4-35	F4-36	F4-37	F4-38	F4-39	F4-40	F4-41	F4-42	F4-43	F4-44	F4-45	F4-46	F4-47	F4-48	F4-49
n	33	34	35	36	37	38	39	40	41	42	43	44	45	46	47	48
Multi-step frequency n	F4-50	F4-51	F4-52	F4-53	F4-54	F4-55	F4-56	F4-57	F4-58	F4-59	F4-60	F4-61	F4-62	F4-63	F4-64	F4-65

F5: Digital and relay outputs

No.	Name	Setting range	Default	Change	Page	
F5-00	Y1 terminal	0: Inverter ready 1: Inverter running 2: Frequency reach 3: Frequency reach detection signal 1 4: Frequency reach detection signal 2 5: Fault output 6: Holding brake signal 7: Motor load overweight 8: Motor overload 9: Undervoltage lockout 10: External fault trip 11: Fault auto-reset 12: Restart after momentary power failure	37: X4(after positive & negative logic) 38: X5(after positive & negative logic) 39: X6(after positive & negative logic) 40: X7 (expansion terminal) 41: X8 (expansion terminal) 42: X9 (expansion terminal) 43: X10 (expansion terminal) 44: X11 (expansion terminal)	1	×	85
F5-01	Y2 terminal	13: Alarm output 14: Reverse running 15: Stopping 16: Run interruption	45: FWD(after positive & negative logic) 46: REV(after positive & negative logic)	2		

5 Parameter table

No.	Name	Setting range	Default	Change	Page
F5-02	T1 relay output	17: Keypad control 18: Torque limit 19: Frequency upper limit 20: Frequency lower limit 21: Running in generating state 22: Running at zero speed 23: Zero servo finished 24: PLC operation 25: PLC operation pause 26: PLC stage finished 47: Comparator output 48: Comparator output 49: Logic unit 1 output 50: Logic unit 2 output 51: Logic unit 3 output 52: Logic unit 4 output 53: Timer 1 output 54: Timer 2 output 55: Timer 3 output 56: Timer 4 output 57: Encoder A channel 58: Encoder B channel 59: PFI terminal status 60: Virtual revolution-counting pulse 61: PLC mode 0 indication 62: PLC mode 1 indication 示 63: PLC mode 2 indication	5		

No.	Name	Setting range	Default	Change	Page
F5-03	T2 relay output	27: PLC cycle finished 28: PC digital 1 29: PC digital 2 30: Wobble frequency upper/lower limit 31: Setpoint count reach 32: Designated count reach 33: Meter-counter setpoint length reach 34: X1(after positive & negative logic) 35: X2(after positive & negative logic) 36: X3(after positive & negative logic) 64: PLC mode 3 indication 65: PLC mode 4 indication 66: PLC mode 5 indication 67: PLC mode 6 indication 68: PLC mode 7 indication 69: Designated count 2 reach 70: Logic unit 5 output 71: Logic unit 6 output 72: End of expected life of air blower 73: Process PID sleeping	13	×	86
F5-04	Y output logic(positive & negative)	Tens digit: Y2 Units digit: Y1	00	×	88
F5-05	Frequency reach detection band	0.00~650.00Hz	2.50Hz	○	88
F5-06	Frequency reach detection level 1	0.00~650.00Hz	50.00Hz	○	88
F5-07	Frequency reach detection hysteresis 1	0.00~650.00Hz	1.00Hz	○	88
F5-08	Frequency reach detection level 2	0.00~650.00Hz	25.00Hz	○	88
F5-09	Frequency reach detection hysteresis 2	0.00~650.00Hz	1.00Hz	○	88

No.	Name	Setting range	Default	Change	Page
F5-10	Y1 terminal closing delay	0.00~650.00s	0.00s	○	89
F5-11	Y1 terminal opening delay		0.00s		
F5-12	Y2 terminal closing delay		0.00s		
F5-13	Y2 terminal opening delay		0.00s		
F5-14	T1 terminal closing delay	0.00~650.00s	0.00s	○	89
F5-15	T1 terminal opening delay		0.00s		
F5-16	T2 terminal closing delay		0.00s		
F5-17	T2 terminal opening delay		0.00s		

F6: Analog and pulse frequency terminals

No.	Name	Setting range	Default	Change	Page
F6-00	AI1 input type	0: 0~10V or 0~20mA(corresponding to 0~100%) 1: 10~0V or 20~0mA(corresponding to 0~100%) 2: 2~10V or 4~20mA(corresponding to 0~100%) 3: 10~2V or 20~4mA(corresponding to 0~100%) 4: -10~10V or -20~20mA(corresponding to -100~100%) 5: 10~-10V or 20~-20mA(corresponding to -100~100%) 6: 0~10V or 0~20mA(corresponding to -100~100%) 7: 10~0V or 20~0mA(corresponding to -100~100%)	0	○	89
F6-01	AI1 gain	0.0~1000.0%	100.0%	○	89
F6-02	AI1 bias	-99.99~99.99%(10V or 20mA=100%)	0.00%	○	89
F6-03	AI1 filtering time	0.000~10.000s	0.100s	○	90
F6-04	AI1 zero-point threshold	0.0~50.0%	1.0%	○	90
F6-05	AI1 zero-point hysteresis error	0.0~50.0%	0.0%	○	90
F6-06	AI1 disconnection threshold	0.0~20.0%(10V or 20mA=100%) Note: For 2~10V/4~20mA or 10~2V/20~4mA, the internal disconnection threshold is fixed at 10%; for -10~10V or -20~20mA, the disconnection test is not performed.	0.0%	○	90

5 Parameter table

No.	Name	Setting range	Default	Change	Page
F6-07	AI2 input type	Same as F6-00	0	○	90
F6-08	AI2 gain	0.0~1000.0%	100.0%	○	90
F6-09	AI2 bias	-99.99~99.99%(10V or 20mA=100%)	0.00%	○	90
F6-10	AI2 filtering time	0.000~10.000s	0.100s	○	90
F6-11	AI2 zero-point threshold	0.0~50.0%	1.0%	○	90
F6-12	AI2 zero-point hysteresis error	0.0~50.0%	0.0%	○	90
F6-13	AI2 disconnection threshold	Same as F6-06	0.0%	○	90
F6-14	AO1 function	0: Operating frequency 1: Reference frequency 2: Output current 3: Output voltage 4: Output power 5: Output torque 6: Reference torque 7: PID feedback value 8: PID reference value 9: PID output value 10: AI1 11: AI2 12: PFI 13: UP/DOWN value 14: DC link voltage 15: Reference frequency after accel/decel 16: PG detection frequency 17: Counter error percentage 19: Arithmetic unit 1 output 20: Arithmetic unit 2 output 21: Arithmetic unit 3 output 22: Arithmetic unit 4 output 23: Arithmetic unit 5 output 24: Arithmetic unit 6 output 25: Low-pass filter output 26: Low-pass filter output 27: Analog multiple switching output 28: Comparator digital setting 29: Comparator digital setting 30: Arithmetic unit digital setting 31: Arithmetic unit digital setting 32: Arithmetic unit digital setting 33: Arithmetic unit digital setting 34: Arithmetic unit digital setting 35: Arithmetic unit digital setting 36: PC analog 1 37: PC analog 2 38: Factory output 1 39: Factory output 2 40: Output frequency (for factory use) 41: Keypad POT value 42: Count value of counter 2 43: Temperature of radiator 1 44: Temperature of radiator 2	0	○	92

No.	Name	Setting range	Default	Change	Page
F6-15	AO1 type	0: 0~10V or 0~20mA 1: 2~10V or 4~20mA 2: 5V or 10mA at the center	0	○	92
F6-16	AO1 gain	0.0~1000.0%	100.0%	○	92
F6-17	AO1 bias	-99.99~99.99%(10V or 20mA=100%)	0.00%	○	92
F6-18	AO2 function	Same as F6-14	2	○	92
F6-19	AO2 type	Same as F6-15	0	○	92
F6-20	AO2 gain	0.0~1000.0%	100.0%	○	92
F6-21	AO2 bias	-99.99~99.99%(10V or 20mA=100%)	0.00%	○	92
F6-22	PFI frequency corresponding to 100%	0~50000Hz	10000Hz	○	93
F6-23	PFI frequency corresponding to 0%	0~50000Hz	0Hz	○	93
F6-24	PFI filtering time	0.000~10.000s	0.100s	○	93
F6-25	PFO function	Same as F6-14	0	○	94
F6-26	PFO output pulse modulation method	0: Frequency modulation 1: Duty-ratio modulation	0	○	94
F6-27	PFO frequency corresponding to 100%	0~50000Hz (also as the duty-ratio modulation frequency)	10000Hz	○	94
F6-28	PFO frequency corresponding to 0%	0~50000Hz	0Hz	○	94
F6-29	PFO duty ratio corresponding to 100%	0.0~100.0%	100.0%	○	94
F6-30	PFO duty ratio corresponding to 0%	0.0~100.0%	0.0%	○	94

F7: Process PID parameters

No.	Name	Setting range	Default	Change	Page
F7-00	PID control select	0: PID control disabled 1: PID control enabled 2: PID corrects reference frequency prior to accel/decel 3: PID corrects reference frequency after accel/decel 4: PID corrects torque 5: Free PID function	0	×	94
F7-01	PID reference channel	0: F7-04 1: AI1 2: AI2 3: PFI 4: UP/DOWN value 5: Arithmetic unit 1 6: Arithmetic unit 2 7: Arithmetic unit 3 8: Arithmetic unit 4	0	×	95

No.	Name	Setting range	Default	Change	Page
F7-02	PID feedback channel	0: AI1 1: AI2 2: PFI 3: AI1-AI2 4: AI1+AI2 5: $\sqrt{ AI1 }$ 6: $\sqrt{ AI2 }$ 7: $\sqrt{ AI1-AI2 }$ 8: $\sqrt{ AI1 }+\sqrt{ AI2 }$ 9: Arithmetic unit 1 10: Arithmetic unit 2 11: Arithmetic unit 3 12: Arithmetic unit 4	0	×	95
F7-03	PID display coefficient	0.010~10.000(only affects FU-13 and FU-14)	1.000	○	96
F7-04	PID digital reference	-100.0~100.0%	0.0%	○	96
F7-05	Proportional gain 1	0.00~100.00	0.20	○	96
F7-06	Integral time 1	0.01~100.00s	20.00s	○	96
F7-07	Differential time 1	0.00~10.00s	0.00s	○	96
F7-08	Proportional gain 2	0.00~100.00	0.20	○	96
F7-09	Integral time 2	0.01~100.00s	20.00s	○	96
F7-10	Differential time 2	0.00~10.00s	0.00s	○	96
F7-11	PID parameter switching	0: By digital input 36 1: According to operating frequency 2: Arithmetic unit 1 3: Arithmetic unit 2 4: Arithmetic unit 3 5: Arithmetic unit 4	0	×	96
F7-12	Sampling period	0.001~10.000s	0.010s	○	97
F7-13	Error limit	0.0~20.0%(PID setpoint=100%)	0.0%	○	97
F7-14	Setpoint up/down time	0.00~20.00s	0.00s	○	97
F7-15	PID regulation characteristic	0: Positive 1: Negative	0	×	97
F7-16	Integral regulation	0: Disabled 1: Enabled	1	×	98
F7-17	PID upper limit	F7-18~100.0%	100.0%	○	98
F7-18	PID lower limit	-100.0%~F7-17	0.0%	○	98
F7-19	PID differential limit	0.0~100.0%(limits the max. and min. value of differential component)	5.0%	○	98
F7-20	PID preset	F7-18~F7-17	0.0%	○	98
F7-21	PID preset holding time	0.0~3600.0s	0.0s	×	98
F7-22	Multi-PID setpoint 1	-100.0~100.0%	1.0%	○	98
F7-23	Multi-PID setpoint 2		2.0%		
F7-24	Multi-PID setpoint 3		3.0%		
F7-25	Multi-PID setpoint 4		4.0%		
F7-26	Multi-PID setpoint 5		5.0%		
F7-27	Multi-PID setpoint 6		6.0%		
F7-28	Multi-PID setpoint 7		7.0%		

F8: Simple PLC

No.	Name	Setting range	Default	Change	Page
F8-00	PLC operation setting	Units digit: PLC cycle mode 0: PLC operation disabled 1: N cycles(cycle number decided by F8-02)+stop 2: N cycles +final stage speed (cycle number decided by F8-02) 3: Continuous cycle Tens digit: PLC restart mode 0: Restart from the first stage 1: Restart from the frequency of the interrupted stage 2: Restart from the operating frequency at the moment of interruption Hundreds digit: Whether to save PLC status parameters after power-off 0: Not store 1: Store Thousands digit: Unit of time for each stage 0: Second 1: Minute	0000	×	98
F8-01	PLC mode	Units digit: PLC mode/stage number 0: 1×48, 1 mode, 48 stages 1: 2×24, 2 modes, 24 stages for each mode 2: 3×16, 3 modes, 16 stages for each mode 3: 4×12, 4 modes, 12 stages for each mode 4: 6×8, 6 modes, 8 stages for each mode 5: 8×6, 8 modes, 6 stages for each mode Tens digit: PLC mode select 0: Binary code select 1: Direct select 2~9: Mode 0~7	00	×	99
F8-02	PLC cycle number	1~65535	1	×	99
F8-03 ~ F8-97	Stage(1~48) setting	Units digit: Direction 0: Forward 1: Reverse Tens digit: Accel/decel time select 0: Accel/decel time 1 1: Accel/decel time 2 2: Accel/decel time 3 3: Accel/decel time 4 4: Accel/decel time 5 5: Accel/decel time 6 6: Accel/decel time 7 7: Accel/decel time 8	00	○	99
F8-04 ~ F8-98	Stage(1~48) time	0.0~6500.0(second or minute) The time unit is determined by the thousands digit of F8-00	0.0	○	99

Parameters of PLC and multistage frequency are as follows (refer to Page 85 for PLC mode and step divisions:)

n	1	2	3	4	5	6	7	8	9	10	11	12	13	14	15	16
Stage n setting	F8-03	F8-05	F8-07	F8-09	F8-11	F8-13	F8-15	F8-17	F8-19	F8-21	F8-23	F8-25	F8-27	F8-29	F8-31	F8-33
Stage n time	F8-04	F8-06	F8-08	F8-10	F8-12	F8-14	F8-16	F8-18	F8-20	F8-22	F8-24	F8-26	F8-28	F8-30	F8-32	F8-34

Multistep frequency n	F4-18	F4-19	F4-20	F4-21	F4-22	F4-23	F4-24	F4-25	F4-26	F4-27	F4-28	F4-29	F4-30	F4-31	F4-32	F4-33
n	17	18	19	20	21	22	23	24	25	26	27	28	29	30	31	32
Stage n setting	F8-35	F8-37	F8-39	F8-41	F8-43	F8-45	F8-47	F8-49	F8-51	F8-53	F8-55	F8-57	F8-59	F8-61	F8-63	F8-65
Stage n time	F8-36	F8-38	F8-40	F8-42	F8-44	F8-46	F8-48	F8-50	F8-52	F8-54	F8-56	F8-58	F8-60	F8-62	F8-64	F8-66
Multistep frequency n	F4-34	F4-35	F4-36	F4-37	F4-38	F4-39	F4-40	F4-41	F4-42	F4-43	F4-44	F4-45	F4-46	F4-47	F4-48	F4-49
n	33	34	35	36	37	38	39	40	41	42	43	44	45	46	47	48
Stage n setting	F8-67	F8-69	F8-71	F8-73	F8-75	F8-77	F8-79	F8-81	F8-83	F8-85	F8-87	F8-89	F8-91	F8-93	F8-95	F8-97
Stage n time	F8-68	F8-70	F8-72	F8-74	F8-76	F8-78	F8-80	F8-82	F8-84	F8-86	F8-88	F8-90	F8-92	F8-94	F8-96	F8-98
Multistep frequency n	F4-50	F4-51	F4-52	F4-53	F4-54	F4-55	F4-56	F4-57	F4-58	F4-59	F4-60	F4-61	F4-62	F4-63	F4-64	F4-65

F9: Wobble frequency, counter, meter-counter and zero-servo

No.	Name	Setting range	Default	Change	Page
F9-00	Wobble frequency injection mode	0: Disabled 1: Auto injection 2: Manual injection	0	×	103
F9-01	Wobble amplitude control	0: Center frequency=100% 1: Max. frequency=100%	0	×	103
F9-02	Preset wobble frequency	F0-08~F0-07	0.00Hz	○	103
F9-03	Prese wobble frequency waiting time	0.0~3600.0s	0.0s	○	103
F9-04	Wobble frequency amplitude	0.0~50.0 % (relative to center frequency or Max. frequency)	0.0%	○	103
F9-05	Sudden jump frequency	0.0~50.0 % (actual wobble frequency amplitude=100%)	0.0%	○	103
F9-06	Sudden jump time	0~50ms	0ms	○	103
F9-07	Wobble period	0.1~1000.0s	10.0s	○	103
F9-08	Rising time	0.0~100.0%(F9-07=100%)	50.0%	○	104
F9-09	Wobble randomness	0.0~50.0%(F9-07=100%)	0.0%	○	104
F9-10	Wobble restart and power-off setting	Units digit: Wobble restart mode afte stop 0: Smooth restart 1: Restart from zero Tens digit: Whether to save the wobble frequency status after power-off 0: Save 1: Not save	00	×	104
F9-11	Counter UP command select	Same as F5-00. Selecting digital outputs 57~59 can achieve high-speed counting.	57	○	105
F9-12	Counter DOWN command select		58	○	105
F9-13	Counter preset value	0~65535	0	○	105
F9-14	Setpoint count	F9-15~65535	10000	○	105

No.	Name	Setting range	Default	Change	Page
F9-15	Designated count	0~F9-14	0	○	105
F9-16	Counter frequency-deviding coefficient	1~65535	1	○	106
F9-17	Meter-counter input command select	Same as F5-00 Selecting digital outputs 57~59 can realize high-speed meter counting.	0	○	107
F9-18	Meter-counter setpoint length	0~65535m	1000m	○	107
F9-19	Meter-counter pulse number per meter	0.1~6553.5	100.0	○	107
F9-20	Zero-servo control	0: Invalid 1: Always valid 2: Conditionally valid(selected by digital input 49)	0	×	107
F9-21	Zero-speed level	0~120r/min	30r/min	×	108
F9-22	Zero-servo ending level	1~10000 pulse(s)	10	○	108
F9-23	Zero-servo control gain	0.00~50.00	1.00	×	108
F9-24	Given position control number	-32768~32767	0	○	108

F9-25 Reserved

~

F9-34

FA: Motor parameters

No.	Name	Setting range	Default	Change	Page
FA-00	Auto-tuning	11: Standstill auto-tuning 22: No-load auto-tuning	00	×	110
FA-01	Motor rated capacity	0.40~1100.00kW/0.4~1200.0kW	Depends on model	×	110
FA-02	Pole number	2~48	4	×	110
FA-03	Motor rated current	0.5~1200.0A	Depends on model	×	110
FA-04	Motor rated frequency	1.00~650.00Hz	50.00Hz	×	110
FA-05	Motor rated speed	125~40000r/min	Depends on model	×	110
FA-06	Motor rated voltage	150~500V, default 380V	380V	×	110
FA-07	Motor no-load current	0.1A~FA-03 "rated current of motor"	Depends on model	×	111

No.	Name	Setting range	Default	Change	Page
FA-08	Motor stator resistance	0.00~50.00%	Depends on model	○	111
FA-09	Motor leakage reactance	0.00~50.00%	Depends on model	○	111
FA-10	Motor rotor resistance	0.00~50.00%	Depends on model	○	111
FA-11	Motor mutual reactance	0.0~2000.0%	Depends on model	○	111
FA-12	Motor core saturation coefficient 1	1.000~1.500	1.300	×	111
FA-13	Motor core saturation coefficient 2	1.000~FA-12 "motor core saturation coefficient 1"	1.100	×	111
FA-14	Motor core saturation coefficient 3	FA-15 " motor core saturation coefficient 4"~1.000	0.900	×	111
FA-15	Motor core saturation coefficient 4	0.500~1.000	0.700	×	112

Fb: Protection functions and advanced settings

No.	Name	Setting range	Default	Change	Page
Fb-00	Motor cooling condition	0: Common motor 1: Inverter-controlled motor or motor with separate cooling fan	0	○	112
Fb-01	Motor overload protection level	50.0~150.0%(motor rated current=100%)	100.0%	○	112
Fb-02	Motor overload action	0: No action 1: Continue running with an alarm 2: Coast to a stop due to fault	2	×	112
Fb-03	Motor load overweight protection	Units digit: inverter input phase loss protection 0: No action 1: Continue running with an alarm 2: Coast to a stop due to fault Tens digit: Action to overweight 0: No action 1: Continue running with an alarm 2: Coast to a stop due to fault	00	×	113
Fb-04	Motor load overweight detection level	20.0~200.0%(motor rated current=100%)	130.0%	×	113
Fb-05	Motor load overweight detection time	0.0~30.0s	5.0s	×	113
Fb-06	Inverter underload protection	0: No action 1: Continue running with an alarm 2: Coast to a stop due to fault	0	×	113
Fb-07	Inverter underload protection level	0.0~100.0%(inverter rated current=100%)	30.0%	×	113

No.	Name	Setting range	Default	Change	Page
Fb-08	underload protection detection time	0.0~100.0s	1.0s	×	113
Fb-09	Analog input disconnection action	0: No action 1: Run at the average frequency within 10s before disconnection, with an AL.Aco alarm 2: Run at the frequency set by Fb-10, with an AL.Aco alarm 3: Coast to a stop, with an Er.Aco alarm	0	×	113
Fb-10	Frequency after analog input disconnection	0.00Hz~F0-06	0.00Hz	○	114
Fb-11	Other protection actions	Units digit: inverter input phase loss protection 0: No action 1: Continue running with an alarm 2: Coast to a stop due to fault Tens digit: inverter output phase loss protection 0: No action 1: Continue running with an alarm 2: Coast to a stop due to fault Hundreds digit: keypad disconnection protection 0: No action 1: Continue running with an alarm 2: Coast to a stop due to fault Thousands digit: parameter store failure protection 0: Continue running with an alarm 1: Coast to a stop due to fault	0022	×	114
Fb-12	Accel overcurrent stall prevention	0: Invalid 1: Valid	1	×	114
Fb-13	Accel overcurrent stall point	10.0~150.0%(inverter rated current=100%)	150.0%	×	114
Fb-14	Constant-speed overcurrent stall prevention	0: Invalid 1: Valid	1	×	114
Fb-15	Constant-speed overcurrent stall point	10.0~150.0%(inverter rated current=100%)	150.0%	×	114
Fb-16	Overvoltage stall prevention	0: Invalid 1: Valid	1	×	114
Fb-17	Overvoltage stall point	650~750V, default 700V	700V	×	115
Fb-18	DC link undervoltage action	0: Coast to a stop and report the undervoltage fault(Er.dcl) 1: Coast to a stop, and restart if the voltage resumes within the time set by Fb-20 or report the undervoltage fault(Er.dcl) if undervoltage time exceeds the time set by Fb-20 2: Coast to a stop, and restart if CPU is still working and detects that the voltage resumes, without reporting the undervoltage fault	0	×	115

No.	Name	Setting range	Default	Change	Page
		3: Decelerate, and accelerate to the reference frequency if CPU is still working and detects that the voltage resumes, without reporting the undervoltage fault.			
Fb-19	DC link undervoltage point	370~480V, default 400V	400V	×	115
Fb-20	Allowable time for momentary power failure	0.0~30.0s	0.1s	×	115
Fb-21	Momentary power failure decel time	0.0~200.0s(if Fb-21=0.0, the current decel time is used)	0.0s	×	115
Fb-22	Auto reset times	0~10	0	×	116
Fb-23	Auto reset interval	1.0~30.0s	5.0s	×	116
Fb-24	Fault output during auto reset	0: No output 1: Output	0	×	116
Fb-25	Restart after momentary stop, auto reset or pause	0: Restart according to the preset starting mode 1: Restart smoothly	1	×	116
Fb-26	Power-on auto reset	0: Disabled 1: Enabled	1	○	116
Fb-27	Built-in braking unit working threshold	620~720V	680V	○	117
Fb-28	Modulation mode	0: Auto 1: Continuous	0	○	117
Fb-29	Carrier frequency	75~160 kW: 1.1k~8.0 kHz, default 2.5kHz 200kW or more: 1.1k~5.0 kHz, default 2.0kHz	Depends on model	○	117
Fb-30	Random PWM setting	0~30%	0%	○	117
Fb-31	Carrier frequency auto adjustment	0: Disabled 1: Enabled	1	○	117
Fb-32	Deadband compensation	0: Disabled 1: Enabled	1	×	117
Fb-33	Space vector angle stop save	0: Not save 1: Save	0	×	117
Fb-34	Over modulation	0: Disabled 1: Enabled	1	×	118
Fb-35	Cooling fan control	0: Stop after standby state lasts 3 minutes 1: Keep running	0	○	118
Fb-36	Jump frequency 1	0.00~625.00Hz	0.00Hz	○	118
Fb-37	Jumping width 1	0.00~20.00Hz	0.00Hz	○	118
Fb-38	Jump frequency 2	0.00~625.00Hz	0.00Hz	○	118
Fb-39	Jumping width 2	0.00~20.00Hz	0.00Hz	○	118
Fb-40	Jump frequency 3	0.00~625.00Hz	0.00Hz	○	118
Fb-41	Jumping width 3	0.00~20.00Hz	0.00Hz	○	118

FC: Keypad operation and display settings

No.	Name	Setting range	Default	Change	Page
FC-00	Display parameter select	0: All menus 1: User selected parameters 2: Parameters different from factory settings	0	○	119
FC-01	Key function and auto lockup	Units digit: determines which keys are locked. 0: None locked 1: All locked 2: All locked but <input type="checkbox"/> 3: All locked but <input type="checkbox"/> 4: All locked but <input type="checkbox"/> and <input type="checkbox"/> 5: All locked but <input type="checkbox"/> and <input type="checkbox"/> Tens digit: determines the function of <input type="checkbox"/> 0: Valid only when keypad is the command source 1: Valid when keypad, terminal or communication is the command source. Stops motor according to preset stop mode. 2: Stops motor according to preset stop mode when keypad is the command source. When other channels are the command coerce, makes the motor coast to a stop and gives an Er.Abb alarm. Hundreds digit: determines the function of <input type="checkbox"/> (only when keypad is command source) 0: Invalid 1: Valid only in standby state 2: Valid Thousands digit: determines the function of <input type="checkbox"/> (only when keypad is command source) 0: Normal run 1: Jog	0000	×	119
FC-02	Monitored parameter 1 (in run and standby)	-1~59 Select monitored parameters which are displayed in both running and standby states.	1	○	119
FC-03	Monitored parameter 2 (in run and standby)	Note: -1 indicates null and 0~59 represent FU-00~FU-59. The minimum value of FC-02 is 0.	-1	○	119
FC-04	Monitored parameter 3 (in run and standby)		-1	○	119
FC-05	Monitored parameter 4 (in run and standby)		-1	○	119
FC-06	Monitored parameter 5 (in run and standby)		-1	○	119
FC-07	Monitored parameter 6 (in run and standby)		-1	○	119
FC-08	Monitored parameter 7 (in run and standby)		-1	○	119
FC-09	Monitored parameter 1 (in run)	-1~59 Select monitored parameters which are only displayed in running state.	0	○	119
FC-10	Monitored parameter 2 (in run)	Note: -1 indicates null and 0~59 represent FU-00~FU-59.	2	○	119
FC-11	Monitored parameter 3 (in run)		4	○	119

5 Parameter table

No.	Name	Setting range	Default	Change	Page
FC-12	Monitored parameter 4 (in run)		-1	○	119
FC-13	Speed display coefficient	0.001~10.000	1.000	○	120
FC-14	Line speed display coefficient	0.01~100.00	0.01	○	120
FC-15 ~ FC-44	User parameters 1~30	-00.01~FU.59(excluding factory parameters Fn) Note: -00.01 indicates null and others represent parameter numbers. For example, F0.01 represents F0-01.	-00.01	○	120
FC-45	User parameter 31	Fixed as FC-00	FC.00	△	120
FC-46	User parameter 32	Fixed as F0-10	F0.10	△	120

Table of User parameters:

n	1	2	3	4	5	6	7	8	9	10	11	12	13	14	15	16
User parameter n	FC-15	FC-16	FC-17	FC-18	FC-19	FC-20	FC-21	FC-22	FC-23	FC-24	FC-25	FC-26	FC-27	FC-28	FC-29	FC-30
n	17	18	19	20	21	22	23	24	25	26	27	28	29	30	31	32
User parameter n	FC-31	FC-32	FC-33	FC-34	FC-35	FC-36	FC-37	FC-38	FC-39	FC-40	FC-41	FC-42	FC-43	FC-44	FC-45	FC-46

Fd: Expansion options and functions

No.	Name	Setting range	Default	Change	Page
Fd-00	Parameter copying	11: Upload parameters from inverter to keypad 22: Download parameters from keypad to inverter 33: Confirm the consistency of keypad parameters with inverter parameters 44: Clear parameters stored in keypad	00	×	120
Fd-01	PG pulse number per revolution	1~8192	1024	×	120
Fd-02	PG type	0: Quadrature encoder 1: Single-channel encoder	0	×	120
Fd-03	PG direction	0: Positive 1: Negative	0	×	121
Fd-04	PG disconnection reaction	0: No action 1: Alarm (AL.PGo displayed) 2: Coast to a stop due to fault(Er.PGo displayed)	2	×	121
Fd-05	PG disconnection detection time	0.1~10.0s	1.0s	×	121
Fd-06	PG speed ratio denominator	1~1000	1	×	121
Fd-07	PG speed ratio numerator	1~1000	1	×	121
Fd-08	PG speed test filtering time	0.000~2.000s	0.005s	○	121
Fd-09	Expansion digital input terminal X7	Options are the same as the function F4-00 of digital output terminal X1	0	×	121

No.	Name	Setting range	Default	Change	Page				
Fd-10	Expansion digital input terminal X8								
Fd-11	Expansion digital input terminal X9								
Fd-12	Expansion digital input terminal X10								
Fd-13	Expansion digital input terminal X11								
Fd-14	Expansion digital output terminal Y3	Same as F5-00	0	×	122				
Fd-15	Expansion digital output terminal Y4								
Fd-16	Expansion digital output terminal Y5								
Fd-17	Expansion digital output terminal Y6								
Fd-18	Expansion digital output terminal Y7								
Fd-19	Counting method					0: Common counting 1: Quadrature counting	0	×	122
Fd-20	Designated count 2					0~F9-14	0	○	122
Fd-21	Logic unit 5 input 1	Same as F5-00	0	○	122				
Fd-22	Logic unit 5 input 2		0	○	122				
Fd-23	Logic unit 5 config	Same as FE-14	9	○	122				
Fd-24	Logic unit 5 output	Same as F4-00	0	○	122				
Fd-25	Logic unit 6 input 1	Same as F5-00	0	○	122				
Fd-26	Logic unit 6 input 2		0	○	122				
Fd-27	Logic unit 6 config	Same as FE-14	9	○	122				
Fd-28	Logic unit 6 output	Same as F4-00	0	○	122				
Fd-29	Electronic gear member settings	1~65535	1	○	122				
Fd-30	Electronic gear denominator settings	1~65535	1	○	122				
Fd-31	Expected service lift settings for air blower	0~65000h	40000h	×	122				
Fd-32	Sleeping frequency	0.00~650.00Hz	40.00Hz	○	122				
Fd-33	Sleeping waiting time	0.0~3600.0s	60.0s	○	122				
No.	Name	Setting range	Default	Change	Page				
Fd-34	Wakeup deviation	0.00~100.00%, note: sleeping function is invalid if it is 100%	100.00%	○	123				
Fd-35	Wakeup delay time	0.000~60.000s	0.500s	○	123				
Fd-36	Rated current 1 of motor	0.5~1200.0A	8.8A	○	124				
Fd-37	Rated current 2 of motor		8.8A	○	124				
Fd-38 ~ Fd-60	Reserved	-	-	-	-				

FE: Programmable unit

No.	Name	Setting range	Default	Change	Page
FE-00	Comparator 1 in-phase input	Same as F6-14	0	○	124
FE-01	Comparator 1 opposite-phase input	Same as F6-14	0	○	124
FE-02	Comparator 1 config	Units digit: selects the functions 0: > 1: < 2: = 3: ≠ 4: Output always 1 5: Output always 0 Tens digit: whether to take absolute value 0: No 1: Yes Hundreds digit: selects the protection function for comparator output 0: No action 1: The motor continues running with an alarm 2: The inverter coasts to a stop due to fault(Er.Co1 or Er.Co2 displayed)	005	○	124
FE-03	Comparator 1 digital setting	-100.0~100.0%(corresponding to analog output 28)	50.0%	○	125
FE-04	Comparator 1 error band	0.0~100.0%	5.0%	○	125
FE-05	Comparator 1 output select	Same as F4-00	0	○	125
FE-06	Comparator 2 in-phase input select	Same as F6-14	0	○	125
FE-07	Comparator 2 opposite-phase input select	Same as F6-14	0	○	125
FE-08	Comparator 2 config	Same as FE-02	005	○	125
FE-09	Comparator 2 digital setting	-100.0~100.0%(corresponding to analog output 29)	50.0%	○	125
FE-10	Comparator 2 error band	0.0~100.0%	5.0%	○	125
FE-11	Comparator 2 output select	Same as F4-00	0	○	125
FE-12	Logic unit 1 input 1 select	Same as F5-00	0	○	126
FE-13	Logic unit 1 input 2 select		0	○	126
FE-14	Logic unit 1 config	0: AND 1: OR 2: NAND 3: NOR 4: XOR(≠) 5: XNOR(=) 6: Output=input 1 7: Output= ~ input 1 8: Output≡1 9: Output≡0 10: R-S trigger	9	○	126
FE-15	Logic unit 1 output select	Same as F4-00	0	○	126
FE-16	Logic unit 2 input 1 select	Same as F5-00	0	○	126
FE-17	Logic unit 2 input 2 select		0	○	126

No.	Name	Setting range	Default	Change	Page
FE-18	Logic unit 2 config	Same as FE-14	9	○	126
FE-19	Logic unit 2 output select	Same as F4-00	0	○	126
FE-20	Logic unit 3 input 1 select	Same as F5-00	0	○	126
FE-21	Logic unit 3 input 2 select		0	○	126
FE-22	Logic unit 3 config	Same as FE-14	9	○	126
FE-23	Logic unit 3 output select	Same as F4-00	0	○	126
FE-24	Logic unit 4 input 1 select	Same as F5-00	0	○	126
FE-25	Logic unit 4 input 2 select		0	○	126
FE-26	Logic unit 4 config	Same as FE-14	9	○	126
FE-27	Logic unit 4 output select	Same as F4-00	0	○	126
FE-28	Timer 1 input select	Same as F5-00	0	○	127
FE-29	Timer 1 config	Units digit: type of timer 0: Rising edge delay 1: Falling edge delay 2: Rising and Falling edge delay 3: Pulse function Tens digit: magnification of set time 0: 1 1: 10 2: 100 3: 1000 4: 10000 5: 100000 Hundreds digit: output signal setting 0: Output=input 1: Output=~input 2: Output≡1 3: Output≡0 4: AND 5: NAND 6: OR 7: NOR	300	○	127
FE-30	Timer 1 set time	0~40000ms. Delay time=set time×magnification	0ms	○	127
FE-31	Timer 1 output select	Same as F4-00	0	○	127
FE-32	Timer 2 input select	Same as F5-00	0	○	127
FE-33	Timer 2 config	Same as FE-29	300	○	127
FE-34	Timer 2 set time	0~40000ms. Delay time=set time×magnification	0ms	○	127
FE-35	Timer 2 output select	Same as F4-00	0	○	127
FE-36	Timer 3 input select	Same as F5-00	0	○	127
FE-37	Timer 3 config	Same as FE-29	300	○	127
FE-38	Timer 3 set time	0~40000ms. Delay time=set time×magnification	0ms	○	127
FE-39	Timer 3 output select	Same as F4-00	0	○	127
FE-40	Timer 4 input select	Same as F5-00	0	○	127
FE-41	Timer 4 config	Same as FE-29	300	○	127
FE-42	Timer 4 set time	0~40000ms. Delay time=set time×magnification	0ms	○	127

No.	Name	Setting range	Default	Change	Page
FE-43	Timer 4 output select	Same as F4-00	0	○	127
FE-44	Arithmetic unit 1 input 1 select	Same as F6-14	0	○	128
FE-45	Arithmetic unit 1 input 2 select		0	○	128
FE-46	Arithmetic unit 1 config	0: Input 1+input 2 1: Input 1-input 2 2: Input 1×input 2 3: Input 1÷input 2 4: Take the smaller one of the two 5: Take the larger one of the two 6: Input 1 ×input 2 7: Input 1 ÷input 2 8: Input 1 is output directly(functions as a connection)	0	○	128
FE-47	Arithmetic unit 1 digital setting	-100.0~100.0%(corresponding to analog output 30)	0.0%	○	128
FE-48	Arithmetic unit 2 input 1 select	Same as F6-14	0	○	128

No.	Name	Setting range	Default	Change	Page
FE-49	Arithmetic unit 2 input 2 select	Same as F6-14	0	○	128
FE-50	Arithmetic unit 2 config	Same as FE-46	0	○	128
FE-51	Arithmetic unit 2 digital setting	-100.0~100.0%(corresponding to analog output 31)	0.0%	○	129
FE-52	Arithmetic unit 3 input 1 select	Same as F6-14	0	○	129
FE-53	Arithmetic unit 3 input 2 select		0	○	129
FE-54	Arithmetic unit 3 config	Same as FE-46	0	○	129
FE-55	Arithmetic unit 3 digital setting	-100.0~100.0%(corresponding to analog output 32)	0.0%	○	129
FE-56	Arithmetic unit 4 input 1 select	Same as F6-14	0	○	129
FE-57	Arithmetic unit 4 input 2 select		0	○	129
FE-58	Arithmetic unit 4 config	Same as FE-46	0	○	129
FE-59	Arithmetic unit 4 digital setting	-100.0~100.0%(corresponding to analog output 33)	0.0%	○	129
FE-60	Arithmetic unit 5 input 1 select	Same as F6-14	0	○	129
FE-61	Arithmetic unit 5 input 2 select		0	○	129
FE-62	Arithmetic unit 5 config	Same as FE-46	0	○	129
FE-63	Arithmetic unit 5 digital setting	-100.0~100.0%(corresponding to analog output 34)	0.0%	○	129
FE-64	Arithmetic unit 6 input 1 select	Same as F6-14	0	○	129

No.	Name	Setting range	Default	Change	Page
FE-65	Arithmetic unit 6 input 2 select		0	○	129
FE-66	Arithmetic unit 6 config	Same as FE-46	0	○	129
FE-67	Arithmetic unit 6 digital setting	-100.0~100.0%(corresponding to analog output 35)	0.0%	○	129
FE-68	Low-pass filter 1 input select	Same as F6-14	0	○	130
FE-69	Low-pass filter 1 filtering time	0.000~10.000s	0.010s	○	130
FE-70	Low-pass filter 2 input select	Same as F6-14	0	○	130
FE-71	Low-pass filter 2 filtering time	0.000~10.000s	0.010s	○	130
FE-72	Analog multi-switch input 1	Same as F6-14	0	○	130
FE-73	Analog multi-switch input 2	Same as F6-14	0	○	130
FE-74	Analog multi-switch control signal	Same as F5-00	0	○	130

FF: Communication parameters

No.	Name	Setting range	Default	Change	Page
FF-00	Communication protocol	0: Modbus 1: USS commands 2: CAN	0	×	130
FF-01	Data format	0: 8,N,1 1: 8,E,1 2: 8,O,1 3: 8,N,2	0	×	130
FF-02	Baud rate	0: 1200bps 1: 2400bps 2: 4800bps 3: 9600bps 4: 19200bps 5: 38400bps 6: 57600bps 7: 115200bps 8: 250000bps 9: 500000bps	3	×	131
FF-03	Local address	0~247	1	×	131
FF-04	Overtime detection time	0.1~600.0s	10.0s	○	131
FF-05	Response delay	0~1000ms	5ms	○	131
FF-06	Overtime reaction	0: No action 1: Alarm 2: Alarm and coast to a stop 3: Alarm and run according to F0-00 4: Alarm and run at upper-limit frequency 5: Alarm and run at lower-limit frequency	0	×	131
FF-07	USS message PZD word number	0~4	2	×	131
FF-08	Communication reference magnification	0.001~30.000	1.000	○	131

Fn: Factory parameter

No.	Name	Description	Default	change
-----	------	-------------	---------	--------

No.	Name	Description	Default	change
-	-	-	-	-

FP: Fault history

No.	Name	Description	Page
FP-00	Last fault type	0: No fault 1. ocb: Momentary overcurrent at start 2. ocA: Overcurrent in accel 3. ocd: Overcurrent in decel 4. ocn: Overcurrent in constant-speed run 5. ouA: Overvoltage in accel 6. oud: Overvoltage in decel 7. ouN: Overvoltage in constant-speed run 8. ouE: Overvoltage in standby state 9. dcL: Undervoltage in run 10. PLI: Input phase loss 11. PLO: Output phase loss 12. FoP: Power device protection 13. oHI: Inverter overheating 14. oLI: Inverter overload 15. oLL: Motor overload 16. EEF: External fault 17. oLP: Motor load overweight 18. ULd: Inverter underload 19. Co1: Comparator 1 output protection signal 20. Co2: Comparator 2 output protection signal 21. EEP: Parameter saving failed 22. CFE: Communication error 23. ccF: Current check error 24. ArF: Poor auto-tuning 25. Aco: Analog input disconnection 26. PGo: PG disconnection 27. rHo: Thermal sensitive resistor open 28. Abb: Abnormal stop 29. Io1: Reserved 30. Io2: Reserved 31. PnL: Keypad disconnection protection	136
FP-01	Cumulated run time at last fault	Min. unit: 1h	136
FP-02	Operating frequency at last fault	Min. unit: 0.01Hz	136
FP-03	Reference frequency at last fault	Min. unit: 0.01Hz	136
FP-04	Output current at last fault	Min. unit: 0.1A	136
FP-05	Output voltage at last fault	Min. unit: 0.1V	136
FP-06	Output capacity at last fault	Min. unit: 0.1kW	136
FP-07	DC link voltage at last fault	Min. unit: 0.1V	136
FP-08	Bridge temperature at last fault	Min. unit: 0.1°C	136
FP-09	Terminal input status 1 at last fault	Ten thousands digit: X5 Thousands digit: X4 Hundreds digit: X3 Tens digit: X2 Units digit: X1	136
FP-10	Terminal input status 2 at last fault	Hundreds digit: REV Tens digit: FWD Units digit: X6	136
FP-11	2nd last fault type	Same as FP-00	136
FP-12	Cumulated run time at 2nd last fault	Min. unit: 1h	136
FP-13	3rd last fault type	Same as FP-00	136
FP-14	Cumulated run time at 3rd last fault	Min. unit: 1h	136
FP-15	4th last fault type	Same as FP-00	136
FP-16	Cumulated run time at 4th last fault	Min. unit: 1h	136
FP-17	5th last fault type	Same as FP-00	136



No.	Name	Description	Page
FP-18	Cumulated run time at 5th last fault	Min. unit: 1h	136
FP-19	Single-time run time at fault	Min. unit: 0.1h	136
FP-20	Fault history clear	11: Clear FP-00~FP-20.	137
FP-21	Voltage of bus 2 during latest fault	Min. unit: 0.1V	137
FP-22	Temperature of inverter bridge 2 during latest fault	Min. unit: 0.1 °C	137

FU: Data monitoring

No.	Name	Description	Page
FU-00	Operating frequency	Min. unit: 0.01Hz	137
FU-01	Reference frequency	Unit indicator blinks. Min. unit: 0.01Hz	137
FU-02	Output current	Min. unit: 0.1A	137
FU-03	Load current percentage	Inverter rated current=100%. Min. unit: 0.1%	137
FU-04	Output voltage	Min. unit: 0.1V	137
FU-05	Operating speed	Min. unit: 1r/min	137
FU-06	Reference speed	Unit indicator blinks. Min. unit: 0.01Hz	137
FU-07	DC link voltage	Min. unit: 0.1V	137
FU-08	Output capacity	Min. unit: 0.1kW	138
FU-09	Output torque	Rated torque=100%. Min. unit: 0.1%	138
FU-10	Reference torque	Rated torque=100%. Unit indicator blinks. Min. unit: 0.1%	138
FU-11	Operating line speed	Min. unit: 1m/s	138
FU-12	Reference line speed	Unit indicator blinks. Min. unit: 1m/s	138
FU-13	PID feedback	Min. unit: 0.1%	138
FU-14	PID reference	Unit indicator blinks. Min. unit: 0.1%	138
FU-15	Counter count	Min. unit: 1	138
FU-16	Meter-counter actual length	Min. unit: 1m	138
FU-17	AI1	Min. unit: 0.1%	138
FU-18	AI2	Min. unit: 0.1%	138

5 Parameter table

No.	Name	Description	Page
FU-19	PFI	Min. unit: 0.1%	138
FU-20	UP/DOWN value	Unit indicator blinks. Min. unit: 0.1%	138
FU-21	PLC current mode and stage	Example: 2.03 indicates the 3rd stage of mode 2.	138
FU-22	PLC cycled number	Min. unit: 1	138
FU-23	Remaining time of PLC current stage	Min. unit: 0.1s or 0.1min, decided by the thousands digit of F8-00	138
FU-24	Arithmetic unit 1 output	Min. unit: 0.1%	138
FU-25	Arithmetic unit 2 output	Min. unit: 0.1%	138
FU-26	Arithmetic unit 3 output	Min. unit: 0.1%	138
FU-27	Arithmetic unit 4 output	Min. unit: 0.1%	138
FU-28	Arithmetic unit 5 output	Min. unit: 0.1%	138
FU-29	Arithmetic unit 6 output	Min. unit: 0.1%	138
FU-30	Low-pass filter 1 output	Min. unit: 0.1%	138
FU-31	Low-pass filter 2 output	Min. unit: 0.1%	138
FU-32	Analog multi-switch output	Min. unit: 0.1%	138
FU-33	PID output	Min. unit: 0.1%	138
FU-34	Counter error	F9-14=100%. Min. unit: 0.01%	138
FU-35	PG detection frequency	Min. unit: 0.1Hz	138
FU-36	Heat sink temperature	Min. unit: 0.1°C	138
FU-37	Output power factor	Min. unit: 0.01	138
FU-38	Watt-hour meter kWh	0.0~6553.5kWh. Pressing Δ and \odot concurrently clears this parameter itself and the watt-hour meter timer.	138
FU-39	Watt-hour meter timer	0.00~655.35h. Pressing Δ and \odot concurrently clears this parameter itself and the watt-hour meter kWh.	139
FU-40	Digital input terminal status 1	Ten thousands digit: X5 Thousands digit: X4 Hundreds digit: X3 Tens digit: X2 Units digit: X1 (0: Open 1: Closed)	139
FU-41	Digital input terminal status 2	Hundreds digit: REV Tens digit: FWD Units digit: X6 (0: Open 1: Closed)	139
FU-42	Digital output terminal status	Thousands digit: T2 Hundreds digit: T1 Tens digit: Y2 Units digit: Y1 (0: Open 1: Closed)	139

No.	Name	Description	Page
FU-43	Expansion digital input terminal status	Ten thousands digit: X11 Thousands digit: X10 Hundreds digit: X9 Tens digit: X8 Units digit: X7 (0: Open 1: Closed)	139
FU-44	Expansion digital output terminal status	Ten thousands digit: Y7 Thousands digit: Y6 Hundreds digit: Y5 Tens digit: Y4 Units digit: Y3 (0: Open 1: Closed)	139
FU-45	Communication error times	0~60000	139
FU-46	Reference frequency after accel/decel	Min. unit: 0.01Hz	139
FU-47	Output frequency	Freuqney output by the inverter (used by factory). Min. unit: 0.01Hz	139
FU-50	Coder position high value	Feedback position high 16 digits of coder indicated in binary system	139
FU-51	Coder position low value	Feedback position low 16 digits of coder indicated in binary system	139
FU-52	Communication poll cycle	Min. unit: 0.001s	139
FU-53	Counting high value of counter 2	Counting value high 16 digits indicated in binary system	139
FU-54	Counting low value of counter 2	Counting value low 16 digits indicated in binary system	139
FU-55	Max. current holding	It is cleared by pressing  and  concurrently. Min. unit: 0.1A	139
FU-60	Accumulated operation time of air blower	Min. unit: 1h	139
Others	Reserved	-	-

6 Parameter Description

6.1 F0: Basic Parameters

F0-00	Digital reference frequency	Default	50.00Hz	Change	○
Setting range	0.00Hz~F0-06				
F0-01	Main reference channel	Default	0	Change	○
Setting range	0: F0-00(adjusted via ▲ & ▼ keys) 1: Communication(F0-00 as initial value) 2: UP/DOWN value 3: AI1 4: AI2 5: PFI 6: Arithmetic unit 1 7: Arithmetic unit 2 8: Arithmetic unit 3 9: Arithmetic unit 4 10: Keypad POT				

The reference frequency channels are shown in the following diagram:

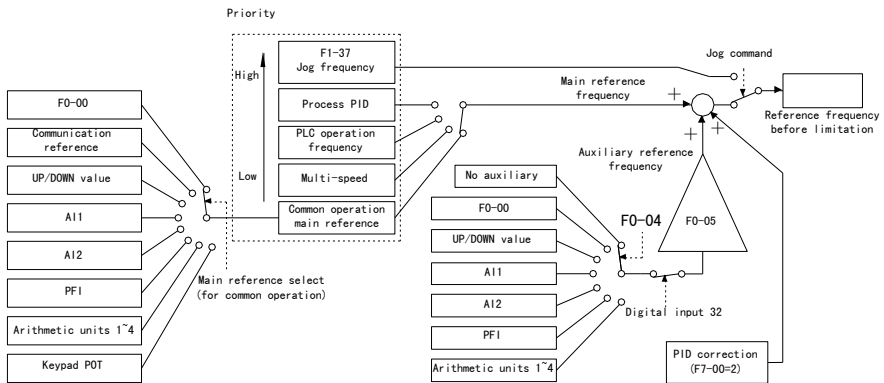

The inverter has 5 operation modes and their priorities are: jog>process PID>PLC>multi-speed>common operation. For example, if multi-speed operation is valid when the inverter is in common operation, the main reference frequency will be determined by the multistep frequency.

In common operation, the main reference frequency can be selected by F0-01, and the frequency setting channel can be compulsively switched to AI1 and Arithmetic unit 1 by digital input 43 and 44 respectively (see page 78 for details).

Auxiliary reference channel is selected by F0-04 and it can be disabled by digital input 32.

Setting F7-00=2 can correct the reference frequency before acceleration/deceleration.









Jog command is valid in following cases: 1) In keypad control mode, the thousands digit of FC-01 equals 1; or 2) In terminal control mode, digital input 14 or 15 is valid.

The reference frequency is restricted by F0-07 and F0-08.

F0-02	Command source	Default	0	Change	×
Setting range	0: Keypad(EXT off) 1: Terminal(EXT on) 2: Communication(EXT blinks)				

When F0-02=0, can change the run direction, the default of which is forward. The function of is determined by the hundreds digit of FC-01.

 Digital input 42 can compulsively switch the command source (see page 78 for details).

F0-03	Frequency holding	Default	00	Change	○
Setting range	Units digit: selects the frequency saving mode after power failure.	0: Frequency changed via  ,  or communication is stored in F0-00.	1: Frequency changed via  ,  or communication is not stored.		
	Tens digit: selects the frequency holding mode in stop state.	0: Frequency changed via  ,  or communication is retained.	1: Frequency changed via  ,  or communication is restored to F0-00.		

 This parameter is valid only when F0-01=0 or 1.

F0-04	Auxiliary reference channel	Default	0	Change	○
Setting range	0: None 1: F0-00 2: UP/DOWN value 3: AI1 4: AI2 5: PFI 6: Arithmetic unit 1 7: Arithmetic unit 2 8: Arithmetic unit 3 9: Arithmetic unit 4				
F0-05	Auxiliary reference gain	Default	1.000	Change	○
Setting range	-1.000~1.000				

 Refer to F0-00 and F0-01.

F0-06	Max. frequency	Default	50.00Hz	Change	×
Setting range	V/F control: F0-07~650.00Hz Vector control: F0-07~200.00Hz				
F0-07	Upper-limit frequency	Default	50.00Hz	Change	×
Setting range	F0-08~F0-06				
F0-08	Lower-limit frequency	Default	0.00Hz	Change	×
Setting range	0.00Hz~F0-07				

 F0-06 is the frequency corresponding to 100% of the frequency setting.

 F0-07 and F0-08 limit the size of the reference frequency.

F0-09	Direction lock	Default	0	Change	○
Setting range	0: Forward or reverse 1: Forward only 2: Reverse only				

 It is recommended to set F0-09 to 1 or 2 when only a single direction is required.

 If you want to change the direction via the key , you should set the hundreds digit of FC-01 to 1 or 2.

F0-10	Parameter protection	Default	0	Change	○
Setting range	0: All parameters can be changed except read-only ones 1: All parameters can't be changed except F0-00, F7-04 and F0-10 2: All parameters can't be changed except F0-10				

 F0-10 is used to prevent parameters from being modified unexpectedly.

F0-11	Parameter initialization	Default	00	Change	×

Setting range	11: Enabled 22: Enabled(except communication parameters) Note: this parameter is automatically set to 00 after initialization.
---------------	---

 F0-11 restores parameters to the factory settings (except the fault history, which can be cleared by FP-20).

F0-12	Motor control mode		Default	0	Change	×
Setting range	0: V/F control without PG 3: Vector control with PG	1: V/F control with PG 4: V/F separate control		2: Vector control without PG		

 Motor control mode:

F0-12=0: open-loop V/F control. The torque output capacity can be improved by torque boost, and the mechanical characteristics and speed control accuracy can be improved by slip compensation.

F0-12=1: closed-loop V/F control. This mode has a high steady-state speed accuracy, and is especially suited for applications where the encoder is not directly installed on the motor shaft and the accurate speed control is needed.

F0-12=2: speed sensor-less vector control. This mode has good mechanical characteristics. It can be used for applications where there is a high demand for driving performance and it is not convenient to install an encoder. Torque control can be achieved under this mode.

F0-12=3: speed sensor vector control. This mode has the highest dynamic performance and steady-state accuracy. It is mainly used for high-performance control such as high-accuracy speed control and simple servo control. Torque control can be achieved under this mode, with high control accuracy both at low speeds and in generating state.

F0-12=4: voltage and frequency can be regulated separately.

 Attentions for vector control

1. Vector control is usually used in cases where one inverter controls one motor. It also can be used to control multiple motors that have the same model and parameters and are connected by a same shaft, however, you should perform the parameter auto-tuning when these motors are connected together, or you can manually input the equivalent parameters when these motors are connected in parallel.
2. Motor parameter auto-tuning or accurate motor parameter input is needed for motor dynamic modeling and field-oriented control algorithm.
3. The capacity of the motor and inverter must match each other. The motor rated current should not less than 1/4 of the inverter rated current; too low value would harm the control performance.
4. ASR parameters must be properly set to ensure the steady-state performance and dynamic performance of speed control.
5. It is recommended that the motor pole number not be greater than eight, and vector control not be used for double-cage motors, current-displacement motors or torque motors.
6. F2-12 "basic frequency" is the same as rated frequency of motor, which is convenient for high-speed field-weakening control.

 V/F control is required in following cases:

1. One inverter drives multiple motors simultaneously (the motors have uneven loads or different parameters or capacities).
2. Load current is less than 1/4 of the inverter rated current.
3. No load is connected to the inverter (e.g. during test).
4. Inverter output is connected to the transformer.

F1-17	Accel/decel time auto switching point	Default	0.00Hz	Change	×
Setting range	0.00~650.00Hz. Accel/decel time is compulsively switched to accel/decel time 8(i.e. F1-14 and F1-15) when the frequency drops below this point.				
F1-18	Decel time for emergency stop	Default	10.0s	Change	○
Setting range	0.01~3600.0s. Minimum unit is determined by F1-16.				

📖 F1-00~F1-15 offer eight accel/decel times, which can be selected by digital inputs 9, 10 and 11(see page 65 for details).

📖 📖 F1-17 is illustrated as below. It is invalid in jog operation, emergency stop and stall prevention.

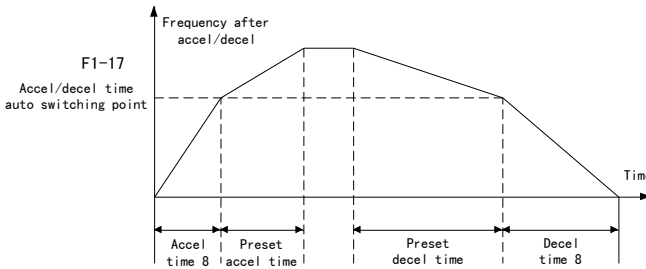

📖 Upon receiving the emergency stop command (digital input 16 or communication command), the inverter will stop according to the time set by F1-18.

F1-19	Starting mode	Default	0	Change	×
Setting range	0: Start from starting frequency 1: Start from starting frequency after DC braking 2: Start from searched speed				
F1-20	Starting frequency	Default	0.50Hz	Change	○
Setting range	0.00~60.00Hz				
F1-21	Starting frequency duration	Default	0.0s	Change	○
Setting range	0.1~60.0s(only valid for V/F control without PG)				
F1-22	Voltage soft start	Default	1	Change	×
Setting range	0: Disabled. Start from the voltage corresponding to the starting frequency. 1: Enabled. The voltage rises smoothly within the time period set by F1-21.				
F1-23	DC braking time(at start)	Default	0.0s	Change	○
Setting range	0.0~60.0s				
F1-24	DC braking current(at start)	Default	0.0%	Change	○
Setting range	0.0~100.0%(inverter rated current=100%)				

📖 The inverter has the following starting modes:

F1-19=0: The motor first runs at the starting frequency (F1-20) for a period of time (F1-21) and then begins accelerating. This mode can reduce the current impact at the start.

F1-19=1: The motor sometimes is in rotation before it starts (for example, the fan motor may run reverse because of the wind). In such a case, the motor can be stopped by DC braking and then restarts, thus preventing the overcurrent impact at the start. Refer to F1-23 and F1-24.

F1-19=2: The speed and the direction of the motor is searched automatically before the motor starts, then the motor starts smoothly from the searched speed. This starting mode shortens the starting time and reduces the impact at the start.

 For restarts following the momentary stop, auto reset or operation interruption, parameter Fb-25 can make the motor start from the searched speed compulsively. If V/F control with PG or Vector control with PG is selected, restart from the searched speed is not needed.

 DC braking at start and stop is illustrated as below.

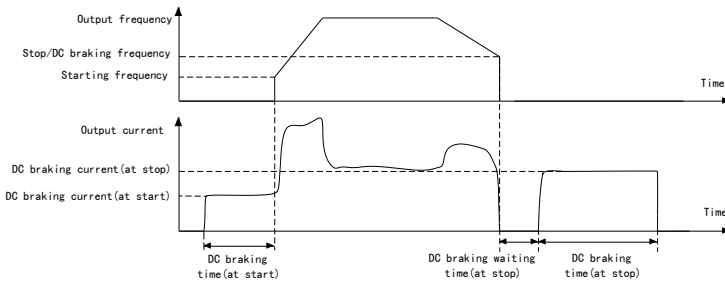

Caution: For high-speed or large-inertia loads, it is recommended to adopt “starts from searched speed” instead of “starts from starting frequency after DC braking”.

Caution: Starting from the starting frequency immediately after a coast stop will cause overcurrent. Therefore if an immediate start is needed when the motor doesn't stop turning after the coast stop, it is recommended to adopt “starts from searched speed”.

 If F1-22=1 when the starting mode is “starts from starting frequency” and F1-21 is not equal to zero, the output voltage will rise gradually from zero to the value which corresponds to the starting frequency within the time period set by F1-21. This helps reduce the impact at the start and prevent unidirectional rotation due to voltage surge. The function is only valid for V/F control without PG.

F1-25	Stop mode	Default	0	Change	○
Setting range	0: Slowdown stop 2: Slowdown+DC braking	1: Coast stop 3: Slowdown+holding brake delay			
F1-26	DC braking frequency(at stop)	Default	0.50Hz	Change	○
Setting range	0.00~60.00Hz				
F1-27	DC braking waiting time(at stop)	Default	0.00s	Change	○
Setting range	0.00~10.00s				
F1-28	DC braking time(at stop)	Default	0.0s	Change	○
Setting range	0.0~60.0s. It's also used as the holding bake delay time.				
F1-29	DC braking current(at stop)	Default	0.0%	Change	○
Setting range	0.0~100.0%(inverter rated current=100%)				

- In S-curve accel/decel mode, the acceleration and speed change gradually and smoothly, which is helpful to raise the comfort degree in elevators, prevent the falling of objects on conveyors, or reduce the impact to equipment at the start/stop.
- The total accel/decel time is extended after the S-curve accel/decel time is set, as shown below.

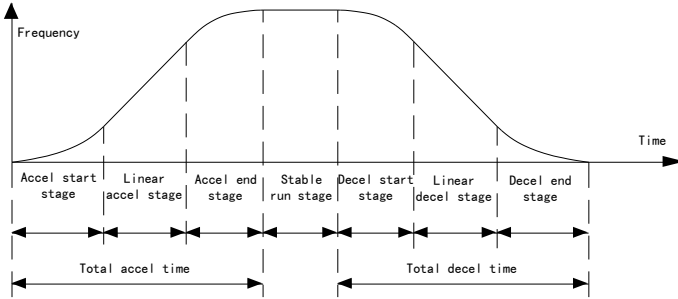

The calculation formula for the total accel/decel time is:

$$\text{Total accel/decel time} = \text{accel/decel time for non S-curve} + (\text{accel/decel start-stage time} + \text{accel/decel end-stage time}) \cdot 2$$

If the total accel/decel time obtained from the above formula is less than the sum of accel/decel start-stage time and accel/decel end-stage time, then:

$$\text{Total accel/decel time} = \text{accel/decel start-stage time} + \text{accel/decel end-stage time}$$

- The S-curve function becomes invalid if F1-17 doesn't equal zero.

F1-36	Deadband time	Default	0.0s	Change	×
Setting range	0.0~3600.0s				

- Deadband time is the waiting time during which the motor switches from forward run to reverse run or vice versa. It is used to reduce the impact to equipment during the forward-reverse switching.

F1-37	Jog frequency	Default	5.00Hz	Change	○
Setting range	0.10~50.00Hz				
F1-38	Jog accel time	Default	Depends on model	Change	○
F1-39	Jog decel time	Default	Depends on model	Change	○
Setting range	0.1~60.0s Note: The factory setting of jog accel/decel time is 6.0s for models of 22 kW or less, and 20.0s for 30kW or above				

- In keypad control mode, if the thousands digit of FC-01 is set to 1, then pressing the key will activate the jog operation, while in terminal control mode the digital input 14 or 15 may activate the jog operation. If both digital inputs are valid or invalid, jog operation will become invalid.
- In jog operation, the functions of “auxiliary reference” and “PID frequency correction” are invalid.
- The start/stop mode for jog operation is fixated to “starts from starting frequency” and “slowdown stop”.

6.3 F2: V/F control parameters

F2-00	V/F curve	Default	1	Change	×
Setting range	0: Self-defined(see F2-14~F2-21) 1: Linear V/F curve(1st power) 2: Reduced-torque V/F curve 1(1.2th power) 3: Reduced-torque V/F curve 2(1.5th power) 4: Reduced-torque V/F curve 3(1.7th power) 5: Reduced-torque V/F curve 4(2.0th power) 6: Reduced-torque V/F curve 5(3.0th power)				

- 📖 V/F curve can be a self-defined multi-segment line, linear line or reduced-torque curve. For the latter two, refer to the diagram below.
- 📖 A reduced-torque V/F curve can improve the efficiency of the motor of a reduced-torque load (such as a fan or pump) in light-load operation. The auto energy-saving operation (see F2-11) also improve the motor efficiency.
- 📖 Apart from improving the motor efficiency, the reduced-torque V/F curve and auto energy-saving operation can decrease the noise.

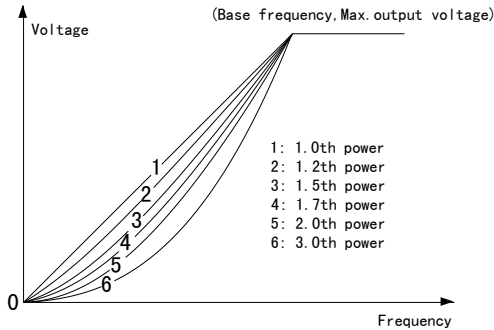

F2-01	Torque boost	Default	1	Change	×
Setting range	0: No boost 1: Manual 2: Auto 3: Manual+auto				
F2-02	Manual torque boost level	Default	Depends on model	Change	○
Setting range	15kW or less: 0.0~15.0% (F2-13=100%) 18.5kW or more: 0.0~10.0%				
F2-03	Auto torque boost cut-off point	Default	10.0%	Change	○
Setting range	0.0~100.0% (F2-12=100%)				
F2-04	Auto torque boost level	Default	100.0%	Change	×
Setting range	0.0~100.0%				

- 📖 Manual torque boost increases the motor's torque at the start or at low speeds. The value of F2-02 should be adjusted gradually until the torque meets the requirement for start. Note that too large F2-02 value will lead to motor overheating or overcurrent.

 The relationship between F2-02, F2-03, F2-12 and F2-13 are shown in the following diagram.

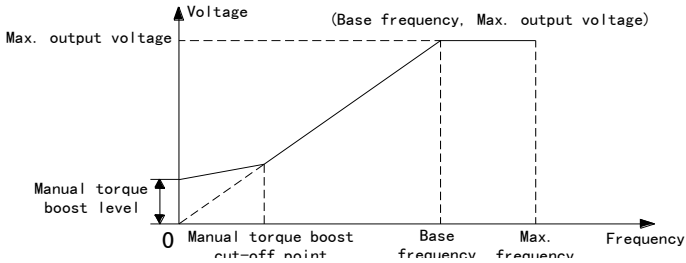



Auto torque boost can alter the voltage according to the load current, compensating for the voltage loss of the stator impedance and adapting to various load conditions automatically. It ensures a large output torque under heavy load and a small output current under no load.

 In V/F control mode, the functions of “starts from searched speed”, “auto torque boost” and “slip compensation” use some motor parameters, therefore we recommend you to conduct the auto-tuning of the motor at a standstill before using them in order to gain a better control.

F2-05	Slip compensation gain	Default	0.0%	Change	○
Setting range	0.0~300.0%				
F2-06	Slip compensation filtering time	Default	1.0s	Change	×
Setting range	0.1~25.0s				
F2-07	Electromotive slip compensation limit	Default	200%	Change	×
F2-08	Regenerative slip compensation limit	Default	200%	Change	×
Setting range	0~250%(motor rated slip frequency=100%)				

 If the output frequency remains constant, the change of the load will cause the change of the slip, thus leading to the drop of the speed. The slip compensation function can regulate the inverter output frequency online according to the load torque, reducing the speed change with the torque and improving the speed control accuracy.

 Slip compensation is valid when F2-01= 2 or 3.

 The size of slip compensation can be adjusted by F2-05. It's better to perform the adjustment when the temperature of the motor running with the load is basically stable. F2-05=100% means the compensation value corresponding to the rated torque is the rated slip frequency, which is calculated from the following formula:

$$\text{Rated slip frequency} = \text{rated frequency} - (\text{rated speed} \times \text{pole number} \div 120)$$

 If the motor vibrates when the slip compensation is performed, increase the value of F2-06 moderately.

F2-09	Vibration damping	Default	Depends on mode	Change	○
Setting range	0~200				

Increasing this parameter can suppress the motor vibration under the no-load or light-load condition.

F2-10	AVR		Default	1	Change	×
Setting range	0: Inactive	1: Active	2: Active except during decel			

AVR is automatic voltage regulation. It keeps the output voltage unaffected when the input voltage or DC link voltage alters, thus stabilizing the production process and product quality.

When the input voltage is higher than the rating, the AVR function should be enabled so that the motor would not run under an overhigh voltage.

Setting F2-10 to 2 allows a quicker deceleration and generates a higher current compared with setting it to 1, because deceleration would raise the DC link voltage and then the output voltage if AVR is inactive, which leads to a greater motor loss and less mechanical energy feedback, therefore the deceleration time can be shorter.

Caution: If the load has a very large moment of inertia, F2-10 should be set to 1 to prevent the overhigh voltage causing motor overheating during deceleration.

F2-11	Auto energy-saving operation		Default	0	Change	○
Setting range	0: Inactive		1: Active			

This function automatically regulates the output voltage, ensuring a minimum load current when the motor speed remains unchanged, thus reducing the motor loss. It's particularly suitable for reduced-torque loads such as fans and pumps. Refer to the diagram below.

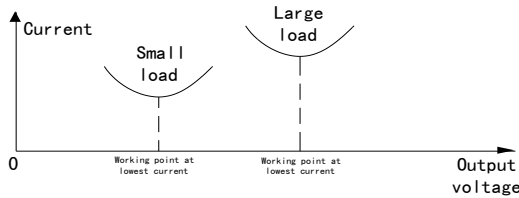



Auto energy-saving operation is only valid for V/F control and only applicable to applications with a stable load.

In the auto energy-saving operation under V/F control, the functions of auto torque boost and slip compensation need to be used together.

F2-12	Base frequency	Default	50.00Hz	Change	×
Setting range	1.00~650.00Hz				
F2-13	Max. output voltage	Default	380V	Change	×
Setting range	150~500V, default 380V				
F2-14	V/F frequency F4	Default	0.00Hz	Change	×
Setting range	F2-16~F2-12				
F2-15	V/F voltage V4	F2-15	V/F voltage V4	F2-15	V/F voltage V4

Setting range	F2-17~100.0%(F2-13=100%)				
F2-16	V/F frequency F3	F2-16	V/F frequency F3	F2-16	V/F frequency F3
Setting range	F2-18~F2-14				
F2-17	V/F voltage V3	F2-17	V/F voltage V3	F2-17	V/F voltage V3
Setting range	F2-19~F2-15(F2-13=100%)				
F2-18	V/F frequency F2	F2-18	V/F frequency F2	F2-18	V/F frequency F2
Setting range	F2-20~F2-16				
F2-19	V/F voltage V2	F2-19	V/F voltage V2	F2-19	V/F voltage V2
Setting range	F2-21~F2-17(F2-13=100%)				
F2-20	V/F frequency F1	F2-20	V/F frequency F1	F2-20	V/F frequency F1
Setting range	0.00Hz~F2-18				
F2-21	V/F voltage V1	F2-21	V/F voltage V1	F2-21	V/F voltage V1
Setting range	0.0%~F2-19(F2-13=100%)				

 F2-12 is effective for V/F control, and its basic frequency shall be the same as FA-04 during vector control.

 The self-defined V/F curve is shown as the following diagram.

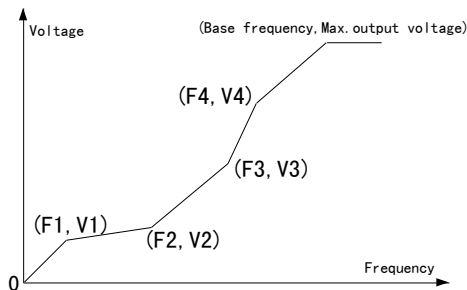

F2-22	V/F separate voltage input	Default	0	Change	×
Setting range	0: F2-23 1: AI1 2: AI2 3: UP/DOWN value 4: PFI 5: Arithmetic unit 1 6: Arithmetic unit 2 7: Arithmetic unit 3 8: Arithmetic unit 4				
F2-23	V/F separate voltage digital setting	Default	100.0%	Change	○
Setting range	0.0~100.0%(F2-13=100%)				
F2-24	V/F voltage factor	Default	0	Change	×
Setting range	0: 100.0% 1: AI1 2: AI2 3: UP/DOWN value 4: PFI 5: Arithmetic unit 1 6: Arithmetic unit 2 7: Arithmetic unit 3 8: Arithmetic unit 4				

- 📖 V/F separate control allows the independent regulation of the converter output voltage or frequency. It can be used for torque motors or linear motors, and used as a programmable power supply.
- 📖 In V/F separate control mode, functions of “torque boost”, “slip compensation” and “vibration damping” become invalid.
- 📖 In V/F separate control mode, voltage soft start is related to starting frequency and starting frequency holding (see page 67 for details).
- 📖 F2-24 corrects the maximum output voltage in many ways. It’s used for motor testing equipment and generally doesn’t need setting by users. It’s only valid in V/F control.

6.4 F3: Speed, torque and flux control parameters

F3-00	High-speed ASR proportional gain	Default	5.00	Change	×
Setting range	0.00~200.00				
F3-01	High-speed ASR integral time	Default	1.000s	Change	×
Setting range	0.010~30.000s				
F3-02	Low-speed ASR proportional gain	Default	10.00	Change	×
Setting range	0.00~200.00				
F3-03	Low-speed ASR integral time	Default	0.500s	Change	×
Setting range	0.010~30.000s				
F3-04	ASR parameter switching point	Default	0.00Hz	Change	×
Setting range	0.00~650.00Hz				
F3-05	ASR filtering time	Default	0.010s	Change	×
Setting range	0.000~2.000s				
F3-06	Accel compensation differential time	Default	0.000s	Change	×
Setting range	0.000~20.000s				
F3-07	Torque limit select	Default	0	Change	×
Setting range	0: Determined by F3-08 and F3-09 1: AI1 ×2.5 2: AI2 ×2.5 3: Arithmetic unit 1 ×2.5 4: Arithmetic unit 2 ×2.5 5: Arithmetic unit 3 ×2.5 6: Arithmetic unit 4 ×2.5				
F3-08	Electromotive torque limit	Default	180.0%	Change	×

F3-09	Regenerative torque limit	Default	180.0%	Change	×
Setting range	0.0~290.0%(motor rated torque=100%). Used for vector control only.				
F3-10	ASR output frequency limit	Default	10.0%	Change	×
Setting range	0.0~20.0%(Max. frequency=100%). Used for PG V/F control only.				

ASR is automatic speed regulator. In vector control ASR outputs the reference torque which is limited by F3-07~F3-09, while in PG V/F control it outputs the frequency correction value which is limited by F3-10.

ASR structure(for vector control) is shown below:

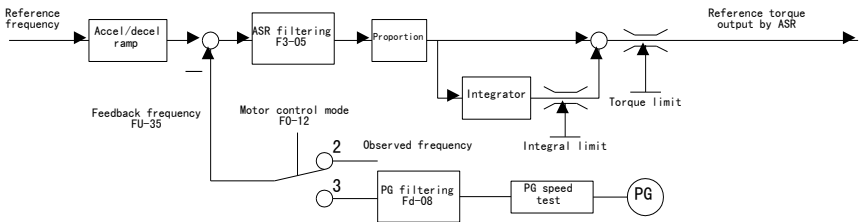

ASR structure (for PG V/F control) is as follows:

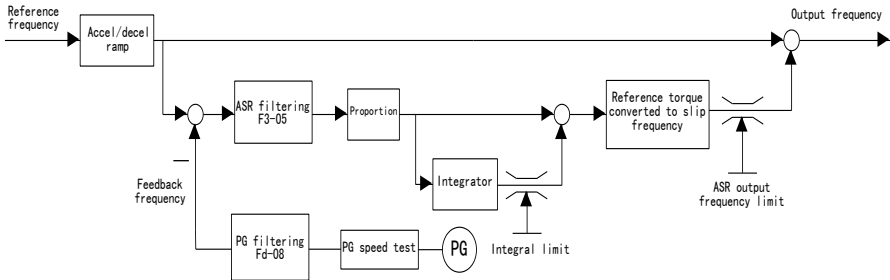

Note: In PG V/F control, if $F3-07=0$, ASR is limited by F3-10; if $F3-07 \neq 0$, $ASR \text{ limit} = F3-10 \times F3-07 \div 2.5$.

F3-04 can be used if different ASR parameters are needed at high-speed and low-speed operation. Low-speed ASR parameters F3-02 and F3-03 are used at zero speed. High-speed ASR parameters F3-00 and F3-01 are used when the operating frequency is higher than F3-04. When the frequency is between zero and F3-04, the ASR parameters are smoothly switched from the low-speed ones to high-speed ones or vice versa, as shown in the following diagram. If only one set of ASR parameters is needed, you can set F3-04 to 0, i.e. only the high-speed ASR parameters are used.

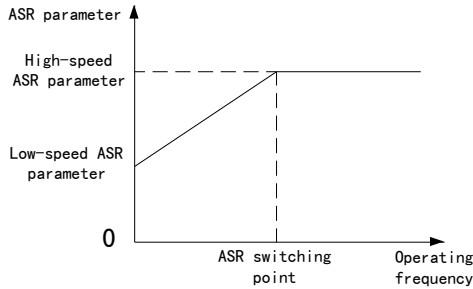

- 📖 F3-06 performs the differential operation on the reference frequency which has been accel/decel treated to obtain a feedforward torque reference, which in turn is added to the reference torque, thus helping the operating frequency better track the reference frequency during accel/decel and reduce the overshoot.
- 📖 ASR regulation principle: first increase the proportional gain as much as possible (but should not cause system oscillation), then adjust the integral time so that the system has a quick sponse and a slight overshoot.
- 📖 If improper parameter settings lead to an excessive speed overshoot, overvoltage may occur due to regenerative energy generated during speed restoring (a deceleration process).

F3-11	Drop level	Default	0.00Hz	Change	○
Setting range	0.00~50.00Hz				
F3-12	Drop starting torque	Default	0.0%	Change	○
Setting range	0.0~100.0%(motor rated torque=100%)				

- 📖 When multiple motors drive the same mechanical load and each motor is controlled by an inverter, each motor and inverter will bear different load because of the disparity in rated speed or mechanical characteristics among different motors. The droop function can balance the load among motors by regulating the hardness or softness of motors' mechanical characteristics.
- 📖 F3-11 set the changing value of the operating frequency when the motor torque equals F3-12 plus rated torque.
- 📖 If motor torque is greater than F3-12,

$$\text{Frequency after droop} = \text{initial reference frequency} - (\text{current torque} - \text{F3-12}) \times \text{droop level}$$

- 📖 The droop mechanical characteristic is shown as the following diagram.

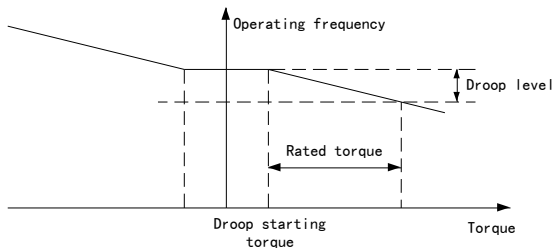

Setting range	50.0~150.0%(only valid for vector control)				
F3-23	Low-speed flux boost	Default	0%	Change	×
Setting range	0~50%(only valid for vector control)				
F3-24	Flux-weakening regulator integral time	Default	0.150s	Change	×
Setting range	0.010~3.000s(only valid for vector control)				

- 📖 F3-21 ensures that the motor has a full pre-excitation and enough starting torque. The pre-excitation time is normally 0.1~2.0s, and the larger the motor capacity, the longer the time.
- 📖 F3-22: its value is better to be below the flux-weakening point. Either overhigh or overlow setting would reduce the torque output capacity and efficiency.
- 📖 F3-23 boosts the flux density when the frequency is below 10% of the base frequency, increasing the torque output capacity at low speeds in the vector control mode.
- 📖 F3-24 automatically applies the flux weakening control to the motor when the latter runs over the base frequency or the DC link voltage is low. It decides the speed of the flux weakening response. Its value needs reducing if there is a high requirement for dynamic performance.

F3-25	Electromotive capacity limit	Default	120.0%	Change	×
F3-26	Regenerative capacity limit	Default	120.0%	Change	×
Setting range	0.0~250.0%(inverter rated capacity=100%). Only used to restrict the output capacity in vector control.				





6.5 F4: Digital input terminals and multistep speed

F4-00	X1 terminal	Default	1	Change	×
F4-01	X2 terminal	Default	2	Change	×
F4-02	X3 terminal	Default	3	Change	×
F4-03	X4 terminal	Default	4	Change	×
F4-04	X5 terminal	Default	12	Change	×
F4-05	X6 terminal	Default	13	Change	×
F4-06	FWD terminal	Default	38	Change	×
F4-07	REV terminal	Default	39	Change	×
Setting range	Refer to the following table.				

- 📖 Table of digital input functions (any two digital input terminals can't select the same digital input function simultaneously).

0: No signal	20: UP/DOWN decrease	40: Analog reference frequency hold
1: Multistep frequency 1	21: UP/DOWN clear	41: Accel/decel disabled
2: Multistep frequency 2	22: PLC control disabled	42: Run command source switched to terminal/keypad
3: Multistep frequency 3	23: PLC operation pause	43: Reference frequency switched to AII(top priority)
4: Multistep frequency 4	24: PLC standby state reset	44: Reference frequency switched to arithmetic unit 1(2nd top priority)
5: Multistep frequency 5	25: PLC mode select 1	
6: Multistep frequency 6	26: PLC mode select 2	
7: Multistep frequency 7	27: PLC mode select 3	

8: Multistep frequency 8	28: PLC mode select 4	45: Speed/torque control select
9: Accel/decel time select 1	29: PLC mode select 5	46: Multi-PID select 1
10: Accel/decel time select 2	30: PLC mode select 6	47: Multi-PID select 2
11: Accel/decel time select 3	31: PLC mode select 7	48: Multi-PID select 3
12: External fault input	32: Auxiliary reference disabled	49: Zero-servo command
13: Fault reset	33: Operation interrupted	50: Counter preset
14: Jog forward	34: DC braking(at stop)	51: Counter clear
15: Jog reverse	35: Process PID disabled	52: Meter-counter clear
16: Emergency stop	36: PID 2	53: Wobble frequency injection
17: Inverter run disabled	37: 3-wire stop command	54: Wobble state reset
18: Coast stop	38: Internal virtual FWD terminal	55: Total run time reset of air blower
19: UP/DOWN increase	39: Internal virtual REV terminal	56: PFI position reverse
		57: Rated current 1 of motor
		58: Rated current 2 of motor

-  Hope800 has eight built-in multi-function programmable digital input terminals(X1~X6, FWD and REV) and offers five expansion input terminals.
-  Each digital input function listed in the table above can also be used as the output of the comparator, logic unit or timer. Refer to Section FE.
-  Related monitored parameters: FU-40 and FU-41.
-  Description of digital input functions:

1~8: Multistep frequency 1~8. Refer to F4-17.

9~11: Accel/decel time select 1~3. The combination of accel/decel time 1, 2 and 3 determines which accel/decel time is selected. Refer to the following table, where “0” indicates invalid, while “1” indicates valid.

Accel/decel time select 3	Accel/decel time select 2	Accel/decel time select 1	Accel/decel time
0	0	0	Accel/decel time 1(F1-00, F1-01)
0	0	1	Accel/decel time 2(F1-02, F1-03)
0	1	0	Accel/decel time 3(F1-04, F1-05)
0	1	1	Accel/decel time 4(F1-06, F1-07)
1	0	0	Accel/decel time 5(F1-08, F1-09)
1	0	1	Accel/decel time 6(F1-10, F1-11)
1	1	0	Accel/decel time 7(F1-12, F1-13)
1	1	1	Accel/decel time 8(F1-14, F1-15)

Note: the function of accel/decel time select is invalid in simple PLC operation, jog operation or emergency stop.

12: External fault input. This signal sends the error or fault information about the peripherals into the inverter, causing the inverter to stop and giving the external fault alarm. This fault can not be reset automatically; it must be reset manually. If you need a normally-closed input, you can negate the digital input terminal by means of F4-09 or F4-10. The external fault can be indicated by the digital output 10(refer to Section 6.6).

13: Fault reset. The rising edge of this signal resets the fault. It has the same function as the key  on the keypad.

14~15: Jog forward/reverse. Refer to page 62 for details.

16: Emergency stop. When this signal is valid, the inverter will stop according to the time set by F1-18.

17: Inverter run disabled. When this signal is valid, the inverter is prohibited to run or coasts to a stop if it is running.

18: Coast stop. If this signal is valid when the inverter is running, the inverter will block the output and the motor will coast to a stop.

19~21: UP/DOWN increase, decrease and clear. Refer to F4-12~F4-16.

22~24: PLC control disable, operation pause and standby state reset. Refer to Section 6.9.

25~31: PLC mode select 1~7. Refer to Section 6.9.

32: Auxiliary reference disabled. When this signal is valid, the auxiliary reference is invalid.

33: Operation interrupted. If this signal is valid when the inverter is running, the inverter will block the output; after this signal is canceled, the inverter will restart according to the mode set by Fb-25. This signal can be indicated by the digital input 16.

34: DC braking(at stop). During stop, if this signal is valid when the operating frequency is less than F1-26 and F1-25=2, the DC braking is introduced until the braking time exceeds F1-28 and this signal is canceled.

35: Process PID disabled. This signal invalidates the PID operation. Only when it is invalid and there is no operation mode with a higher priority than PID, can the PID operation begin.

36: PID parameter 2. If this signal is valid when F7-11=0, the second set of PID parameters(F7-08~F7-10) will be selected, otherwise the first set be selected(F7-05~F7-07).

37~39: 3-wire stop command, internal virtual FWD and REV terminals. Refer to F4-08.

40: Analog reference frequency hold. If this signal is valid when the reference frequency comes from the analog input, the reference frequency will not change with the analog input, otherwise it will. This function is quite useful in applications where the analog input is vulnerable to the electromagnetic disturbance. Refer to the diagram below.

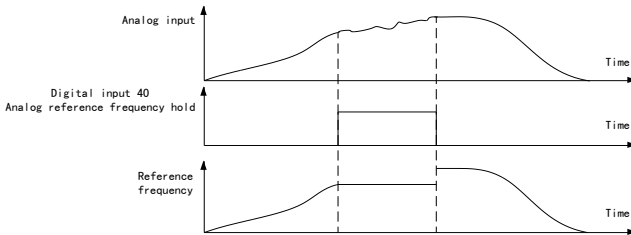

41: Accel/decel disabled. When this signal is valid, the accel/decel process will stop, otherwise the accel/decel process will resume.

42: Run command source switched to terminal/keypad. This signal, in conjunction with F0-02, can switch the command source from one to another, as shown in the following table.

F0-02	State of digital input 42	Command source selected
0: Keypad	Invalid	Keypad
	Valid	Terminal
1: Terminal	Invalid	Terminal
	Valid	Keypad
2: Communication	Invalid	Communication

	Valid	Keypad
--	-------	--------

43: Reference frequency switched to AI1. When this signal is valid, the frequency setting channel will be forcibly switched to AI1, otherwise the frequency setting channel will be restored. If the priority is higher than digital input 44, the frequency setting channel will be switched to arithmetic unit 1.

44: Reference frequency switched to arithmetic unit 1. When this signal is valid, the frequency setting channel will be forcibly switched to arithmetic unit 1, otherwise the frequency setting channel will be restored. If the priority is lower than digital input 43, the frequency setting channel will be switched to AI1.

45: Speed/torque control select. This signal switches the control mode between torque control and speed control. If it is valid, the control mode is speed control, otherwise the torque control.

46-48: Multi-PID select 1-3. The combination of multi-PID select 1, 2 and 3 determines which PID reference is selected, as shown in the table below.

Multi-PID select 3	Multi-PID select 2	Multi-PID select 1	PID reference selected
0	0	0	F7-01
0	0	1	F7-22
0	1	0	F7-23
0	1	1	F7-24
1	0	0	F7-25
1	0	1	F7-26
1	1	0	F7-27
1	1	1	F7-28

49: Zero-servo command. Refer to F9-20~F9-23.

50, 51: Counter preset and clear. Refer to page 89.

52: Meter-counter clear. Refer to the description of meter counter functions in page 94 and counter 2 in page 96.

53, 54: Wobble frequency injection and wobble state reset. Refer to page 103.

55: Total run time reset of air blower. Refer to page 123.

56: PFI position reverse. When determining PFI position, the signal is valid, which makes the position negative. Refer to page 96.

57, 58: Rated current 1 and 2 of motor. For motor overload protection. Refer to Page 124.

F4-08	FWD/REV run mode	Default	1	Change	×
Setting range	0: 1-wire mode(start/stop) 2: 2-wire mode 2(start/stop, direction) 4: 3-wire mode 1(FWD, REV, stop)	1: 2-wire mode 1(FWD, REV) 3: 2-wire mode 3(start, stop) 5: 3-wire mode 2(run, direction, stop)			

 Related digital inputs include 37, 38 and 39.

 The logic and illustration for each mode are listed in the following table, where S indicates “level is valid”, while B indicates “edge is valid”.

F4-08	Mode	Logic	Diagram
-------	------	-------	---------

F4-08	Mode	Logic			Diagram
0	1-wire mode (start/stop)	<p>S: Run switch. When it is valid, the motor runs. Note: The run direction is determined by the direction of the reference frequency.</p>			
1	2-wire mode 1 (FWD, REV)	S2(REV)	S1(FWD)	Result	
		Invalid	Invalid	Stop	
		Invalid	Valid	FWD	
		Valid	Invalid	REV	
Valid	Valid	Stop			
F4-08	Mode	Logic			Diagram
2	2-wire mode 2 (start/stop, direction)	S2(direction)	S1(start/stop)	Result	
		Invalid	Invalid	Stop	
		Invalid	Valid	FWD	
		Valid	Invalid	Stop	
Valid	Valid	REV			
3	2-wire mode 3 (start, stop)	<p>B1: Run button(normally-open) B2: Stop button(normally-closed) Note: The run direction is determined by the direction of the reference frequency.</p>			
4	3-wire mode 1 (FWD, REV, stop) Digital input 37 needed	<p>B1: Stop button(normally-closed) B2: FWD button(normally-open) B3: REV button(normally-open)</p>			
5	3-wire mode 2 (Run, direction, stop) Digital input 37 needed	<p>B1: Stop button(normally-closed) B2: Run button(normally-open) S: Direction switch. When it is valid, the motor runs reverse.</p>			
6	2-wire mode 4 (single pulse start, stop)	<p>B1: FWD button(normally-open) B2: REV button(normally-open)</p>			

In 1-wire mode or 2-wire mode 1 and 2 under the terminal control mode, if the stop command comes from other sources and causes the inverter to stop, then the stop command must be given before the run command in order to restart the inverter.

In 3-wire mode 3 and 3-wire mode, the run button is invalid if the normally-closed stop button is open.

Even if the run direction has been determined, it is still restricted by F0-09(direction lock)

If the terminal command doesn't contain the direction information, the run direction will be determined by the polarity of the reference frequency channel.

Danger: When the run signal exists and Fb-26=1 (default value), the inverter will self start.

F4-09	Input terminal logic 1(positive & negative)	Default	00000	Change	×
Setting range	Ten thousands digit: X5 Thousands digit: X4 Hundreds digit: X3 Tens digit: X2 Units digit: X1 0: Positive logic, valid when circuit is closed and invalid when circuit is open. 1: Negative logic, invalid when circuit is closed and valid when circuit is open.				
F4-10	Input terminal logic 2(positive & negative)	Default	000	Change	×
Setting range	Hundreds digit: REV Tens digit: FWD Units digit: X6 0: Positive logic, valid when circuit is closed and invalid when circuit is open. 1: Negative logic, invalid when circuit is closed and valid when circuit is open.				
F4-11	Digital input terminal anti-jittering time	Default	10ms	Change	○
Setting range	0~2000ms				





 This parameter determines the anti-jittering time for the digital input signal. Those signals with their duration less than the anti-jittering time will be ignored.

F4-12	UP/DOWN regulation mode	Default	0	Change	○
Setting range	0: Level type(terminal) 1: Pulse type(terminal) 2: Level type(keypad) 3: Pulse type(keypad)				
F4-13	UP/DOWN speed/step	Default	1.00	Change	○
Setting range	0.01~100.00. Minimum unit: 0.01%/s(level type), 0.01%(pulse type)				
F4-14	UP/DOWN memory select	Default	0	Change	○
Setting range	0: Stored on power loss 1: Cleared on power loss 2: Cleared at stop or on power loss				
F4-15	UP/DOWN upper limit	Default	100.0%	Change	○
Setting range	0.0~100.0%				
F4-16	UP/DOWN lower limit	Default	0.0%	Change	○
Setting range	-100.0~0.0%				

 The UP/DOWN function allows the continuous regulation in the switching mode. The regulated value can be used as the frequency reference or PID reference.

 **F4-12=0:** When the digital input 19 or 20 is valid, FU-20(UP/DOWN value) increases or decreases at the speed set by F4-13; when the digital inputs 19 and 20 are valid or invalid at the same time, FU-20 remains unchanged.

F4-12=1: When the digital input 19 or 20 is valid, FU-20 increases or decreases a step set by F4-13.

F4-12=2 or 3: Similar to F4-12=0 or 1 respectively, except that the digital inputs 19 and 20 are replaced by keys  and  on the keypad.  and  can be used for regulation only when the value of FU-20 is displayed.

 The two types of UP/DOWN regulation mode are shown as the following diagrams:

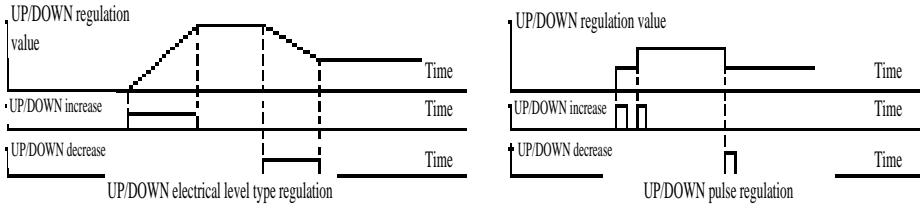

The rising edge of the digital input 21 clears FU-20.

F4-17	Multi-speed select mode	Default	0	Change	×
Setting range	0: Binary code 2: Sum	1: Direct select 3: Number			
F4-18 ~ F4-65	Multistep frequency 1~48	Default	n.00Hz (n=1~48)	Change	○
Setting range	0.00~650.00Hz Note: Multistep frequencies 32~48 are only used for the simple PLC operation. Each multistep frequency's default setting is its respective serial number, for example, the default setting of the multistep frequency 3 is 3.00Hz.				

F4-17=0: The multistep frequency is selected by the combination of the binary codes for the multistep frequency selects 1~5(see Section 6.5), for example, if X1~X5 are set to multistep frequency selects 1~5 respectively, the frequency selecting table will be as follows, where “0” means invalid and “1” means valid.

X5	X4	X3	X2	X1	Result of selection	X5	X4	X3	X2	X1	Result of selection
0	0	0	0	0	Reference frequency for common operation	1	0	0	0	0	Multistep frequency 16 (F4-33)
0	0	0	0	1	Multistep frequency 1 (F4-18)	1	0	0	0	1	Multistep frequency 17 (F4-34)
0	0	0	1	0	Multistep frequency 2 (F4-19)	1	0	0	1	0	Multistep frequency 18 (F4-35)
0	0	0	1	1	Multistep frequency 3 (F4-20)	1	0	0	1	1	Multistep frequency 19 (F4-36)
0	0	1	0	0	Multistep frequency 4 (F4-21)	1	0	1	0	0	Multistep frequency 20 (F4-37)
0	0	1	0	1	Multistep frequency 5 (F4-22)	1	0	1	0	1	Multistep frequency 21 (F4-38)
0	0	1	1	0	Multistep frequency 6 (F4-23)	1	0	1	1	0	Multistep frequency 22 (F4-39)
0	0	1	1	1	Multistep frequency 7 (F4-24)	1	0	1	1	1	Multistep frequency 23 (F4-40)
0	1	0	0	0	Multistep frequency 8 (F4-25)	1	1	0	0	0	Multistep frequency 24 (F4-41)
0	1	0	0	1	Multistep frequency 9	1	1	0	0	1	Multistep frequency 25

					(F4-26)						(F4-42)
0	1	0	1	0	Multistep frequency 10 (F4-27)	1	1	0	1	0	Multistep frequency 26 (F4-43)
0	1	0	1	1	Multistep frequency 11 (F4-28)	1	1	0	1	1	Multistep frequency 27 (F4-44)
0	1	1	0	0	Multistep frequency 12 (F4-29)	1	1	1	0	0	Multistep frequency 28 (F4-45)
0	1	1	0	1	Multistep frequency 13 (F4-30)	1	1	1	0	1	Multistep frequency 29 (F4-46)
0	1	1	1	0	Multistep frequency 14 (F4-31)	1	1	1	1	0	Multistep frequency 30 (F4-47)
0	1	1	1	1	Multistep frequency 15 (F4-32)	1	1	1	1	1	Multistep frequency 31 (F4-48)

F4-17=1: The multistep frequency selects 1~8(see Section 6.5) directly correspond to the multistep frequencies 1~8 respectively, for example, if X1~X8 are set to multistep frequency selects 1~8, the frequency selecting table will be as follows, where “0” indicates invalid, “1” indicates valid and “-” indicates any state.

X8	X7	X6	X5	X4	X3	X2	X1	Result of selection
0	0	0	0	0	0	0	0	Reference frequency for common operation
-	-	-	-	-	-	-	1	Multistep frequency 1 (F4-18)
-	-	-	-	-	-	1	0	Multistep frequency 2 (F4-19)
-	-	-	-	-	1	0	0	Multistep frequency 3 (F4-20)
-	-	-	-	1	0	0	0	Multistep frequency 4 (F4-21)
-	-	-	1	0	0	0	0	Multistep frequency 5 (F4-22)
-	-	1	0	0	0	0	0	Multistep frequency 6 (F4-23)
-	1	0	0	0	0	0	0	Multistep frequency 7 (F4-24)
1	0	0	0	0	0	0	0	Multistep frequency 8 (F4-25)

F4-17=2: The reference frequency equals the sum of all the multistep frequencies selected, but it is still restricted by the upper- and lower-limit frequencies.

Example: if only “multistep frequency select 1”, “multistep frequency select 2” and “multistep frequency select 4” are valid, then

Reference frequency= multistep frequency 1+ multistep frequency 3+multistep frequency 4

F4-17=3: The number of the valid signal(s) among multistep frequency selects 1~8 determines which multistep frequency is used as the reference, for example, if any three of them are valid, then reference frequency=multistep frequency 3.

6.6 F5: Digital output and relay outputs

F5-00	Y1 terminal	Default	1	Change	×
F5-01	Y2 terminal	Default	2	Change	×

F5-02	T1 relay output	Default	5	Change	×
F5-03	T2 relay output	Default	13	Change	×
Setting range	0~73. Refer to the table of digital output functions below.				

Related monitored parameter: FU-42.

Table of digital output functions

0: Inverter ready	25: PLC operation pause	50: Logic unit 2 output
1: Inverter running	26: PLC stage finished	51: Logic unit 3 output
2: Frequency reach	27: PLC cycle finished	52: Logic unit 4 output
3: Frequency reach detection signal	28: PC digital 1	53: Timer 1 output
1	29: PC digital 2	54: Timer 2 output
4: Frequency reach detection signal	30: Wobble frequency upper/lower limit	55: Timer 3 output
2	31: Setpoint count reach	56: Timer 4 output
5: Fault output	32: Designated count reach	57: Encoder A channel
6: Holding brake signal	33: Meter-counter setpoint length reach	58: Encoder B channel
7: Motor load overweight	34: X1(after positive & negative logic)	59: PFI terminal status
8: Motor overload	35: X2(after positive & negative logic)	60: Virtual revolution-counting pulse
9: Undervoltage lockout	36: X3(after positive & negative logic)	61: PLC mode 0 indication
10: External fault trip	37: X4(after positive & negative logic)	62: PLC mode 1 indication
11: Fault auto-reset	38: X5(after positive & negative logic)	63: PLC mode 2 indication
12: Restart after momentary power failure	39: X6(after positive & negative logic)	64: PLC mode 3 indication
13: Alarm output	40: X7(expansion terminal)	65: PLC mode 4 indication
14: Reverse running	41: X8(expansion terminal)	66: PLC mode 5 indication
15: Stopping	42: X9(expansion terminal)	67: PLC mode 6 indication
16: Run interruption	43: X10(expansion terminal)	68: PLC mode 7 indication
17: Keypad control	44: X11(expansion terminal)	69: Designated count 2 reach
18: Torque limit	45: FWD(after positive & negative logic)	70: Logic unit 5 output
19: Frequency upper limit	46: REV(after positive & negative logic)	71: Logic unit 6 output
20: Frequency lower limit	47: Comparator 1 output	72: Expected service life of air blower reached
21: Running in generating state	48: Comparator 2 output	73: Process PID sleeping
22: Running at zero speed	49: Logic unit 1 output	
23: Zero-servo finished		
24: PLC operation		

Detailed description of digital output functions:

0: Inverter ready. The inverter is ready to run.

1: Inverter running. The inverter is in operation.

2: Frequency reach. This signal is valid when the inverter operating frequency falls in the range between reference frequency minus F5-05 and reference frequency plus F5-05. Refer to F5-05.

3~4: Frequency reach detection signals 1 & 2. Refer to F5-06~F5-09.

5: Fault output. It's valid if any failure occurs.

6: Holding brake signal. Refer to F1-25.

- 7: Motor load overweight.** Refer to Fb-03~Fb-05.
- 8: Motor overload.** Refer to page 112.
- 9: Undervoltage lockout.** This signal is valid when DC bus undervoltage causes trip.
- 10: External fault trip.** This signal is valid when an external fault causes trip and becomes invalid after fault reset.
- 11: Fault auto-reset.** This signal is valid when fault auto-reset is in process. Refer to page 115.
- 12: Restart after momentary power failure.** Refer to 115.
- 13: Alarm output.** This signal is valid when the inverter gives an alarm.
- 14: Reverse running.** This signal is valid when the inverter is running reverse.
- 15: Stopping.** This signal is valid when the inverter is in the process of slowdown stop.
- 16: Run interruption.** This signal is valid when the inverter's running is interrupted.
- 17: Keypad control.** This signal is valid when the keypad is used as the command source.
- 18: Torque limit.** This signal is valid when the torque reached the limit value.
- 19: Frequency upper limit.** This signal is valid when reference frequency \geq upper-limit frequency and the operating frequency rises to the upper-limit frequency.
- 20: Frequency lower limit.** This signal is valid when reference frequency \leq lower-limit frequency and the operating frequency falls to the lower-limit frequency.
- 21: Running in generating state.** This signal is valid when the inverter is running in the generating state.
- 22: Running at zero speed.** This signal is valid when the motor speed is lower than F9-21.
- 23: Zero-servo finished.** This signal is valid when the zero-servo position error is less than the zero-servo ending value.
- 24: PLC operation.** This signal is valid when the inverter is in the simple PLC operation mode.
- 25: PLC operation pause.** This signal is valid when the digital input 23 is valid.
- 26: PLC stage finished.** A 500ms pulse is sent out each time a stage of PLC operation is completed.
- 27: PLC cycle finished.** A 500ms pulse is sent out each time a cycle of PLC operation is completed.
- 28~29: PC digitals 1 & 2.** Can be used by the programmable unit. Refer to page 116.
- 30: Wobble frequency upper/lower limit.** Refer to Section 6.10.
- 31, 32, 69: Setpoint count reach, designated count 1 & 2 reach.** Refer to Section 6.10.
- 33: Meter-counter setpoint length reach.** Refer to section 6.10.
- 34~39: X1~X6(after positive & negative logic).** These are digital input signals which have undergone positive & negative logic operation and anti-jittering treatment. They can be used by the programmable unit.
- 40~44: X7~X11(expansion terminals).** These are expansion digital input signals which have undergone anti-jittering treatment and can be used by the programmable unit.
- 45, 46: FWD and REV (after positive & negative logic).** These are digital input signals which have undergone positive & negative logic operation and anti-jittering treatment. They can be used by the programmable unit.
- 47, 48: Comparator 1 & 2 outputs.** Can be used by the programmable unit.
-

49-52, 70, 71: Logic unit 1-6 outputs. Can be used by the programmable unit.

53-56: Timer 1-4 outputs. Can be used by the programmable unit.

57, 58: Encoder A & B channels. Can be used as the high-speed input of the counter and meter-counter.

59: PFI terminal status. Can be used as the high-speed input of the counter and meter-counter.

60: Virtual revolution-counting pulse. It is a pulse signal with a duty ratio of 50%. It can be connected to the counter for the calculation of the winding diameter in winding control.

61-68: PLC mode 0-7 indication. Used to indicate the serial number of current PLC mode

72: Expected service life of air blower reached. Refer to page 123.

73: Process PID sleeping. Refer to page 123.

F5-04	Y output logic(positive & negative)	Default	00	Change	×
Setting range	Tens digit: Y2 Units digit: Y1 0: Positive logic, valid when closed and invalid when open 1: Negative logic, valid when open and invalid when closed				

This parameter can negate the Y1 and Y2 signals and output them.

F5-05	Frequency reach detection band	Default	2.50Hz	Change	○
Setting range	0.00~650.00Hz				

The frequency reach signal is sent out when the inverter operating frequency is in the range between reference frequency minus F5-05 and reference frequency plus F5-05, as shown below.

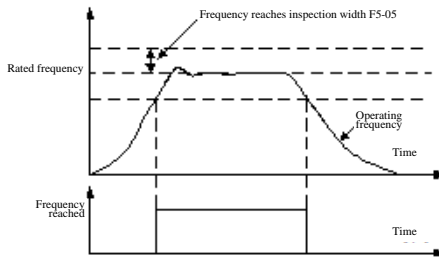

F5-06	Frequency reach detection level 1	Default	50.00Hz	Change	○
F5-07	Frequency reach detection hysteresis 1	Default	1.00Hz	Change	○
F5-08	Frequency reach detection level 2	Default	25.00Hz	Change	○
F5-09	Frequency reach detection hysteresis 2	Default	1.00Hz	Change	○
Setting range	0.00~650.00Hz				

The digital output 3 or 4(frequency reach detection signal) is valid when the operating frequency is greater than the F5-06 or F5-08. It becomes invalid when the operating frequency is less than “frequency reach detection level-frequency reach detection hysteresis”. Refer to the diagram below.

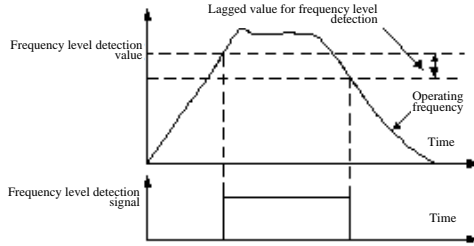

F5-10	Y1 terminal closing delay	Default	0.00s	Change	○
F5-11	Y1 terminal opening delay	Default	0.00s	Change	○
F5-12	Y2 terminal closing delay	Default	0.00s	Change	○
F5-13	Y2 terminal opening delay	Default	0.00s	Change	○
F5-14	T1 terminal closing delay	Default	0.00s	Change	○
F5-15	T1 terminal opening delay	Default	0.00s	Change	○
F5-16	T2 terminal closing delay	Default	0.00s	Change	○
F5-17	T2 terminal opening delay	Default	0.00s	Change	○
Setting range	0.00~650.00s				

The digital output delay is illustrated as follows.

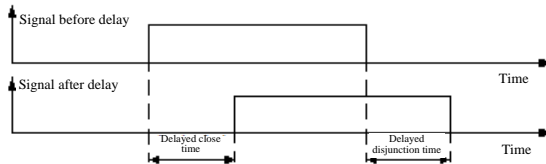

6.7 F6: Analog and pulse frequency terminals

F6-00	AI1 input type	Default	0	Change	○
Setting range	0: 0~10V or 0~20mA(corresponding to 0~100%) 1: 10~0V or 20~0mA(corresponding to 0~100%) 2: 2~10V or 4~20mA(corresponding to 0~100%) 3: 10~2V or 20~4mA(corresponding to 0~100%) 4: -10~10V or -20~20mA(corresponding to -100~100%) 5: 10~-10V or 20~-20mA(corresponding to -100~100%) 6: 0~10V or 0~20mA(corresponding to -100~100%, with 5V or 10mA at the center) 7: 10~0V or 20~0mA(corresponding to -100~100%, with 5V or 10mA at the center) Note: The jumper on the control board chooses whether the input is a voltage-type or current-type input.				
F6-01	AI1 gain	Default	100.0%	Change	○
Setting range	0.0~1000.0%				
F6-02	AI1 bias	Default	0.00%	Change	○

6 Parameter Description

Setting range	-99.99~99.99%(10V or 20mA=100%)				
F6-03	AI1 filtering time	Default	0.100s	Change	○
Setting range	0.000~10.000s				
F6-04	AI1 zero-point threshold	Default	0.0%	Change	○
Setting range	0.0~50.0%				
F6-05	AI1 zero-point hysteresis error	Default	0.0%	Change	○
Setting range	0.0~50.0%				
F6-06	AI1 disconnection threshold	Default	0.0%	Change	○
Setting range	0.0~20.0%(10V or 20mA=100%) Note: For 2~10V/ 4~20mA or 10~2V/20~4mA, the internal disconnection threshold is fixed at 10%; for -10~10V/-20~20mA or 10~-10V/20~-20mA, the disconnection test is not performed.				
F6-07	AI2 input type	Default	0	Change	○
F6-08	AI2 gain	Default	100.0%	Change	○
F6-09	AI2 bias	Default	0.00%	Change	○
F6-10	AI2 filtering time	Default	0.100s	Change	○
F6-11	AI2 zero-point threshold	Default	0.0%	Change	○
F6-12	AI2 zero-point hysteresis error	Default	0.0%	Change	○
F6-13	AI2 disconnection threshold	Default	0.0%	Change	○
Setting range	All settings for AI2 are the same as those for AI1.				

The table below lists the calculation formulas, characteristic curves and regulation diagrams for analog inputs(dotted lines represent factory settings while the solid ones represent regulated settings).

Input	Calculation formula for output	Basic curve	Bias=10.00%	Gain=200.0%
0~10V or 0~20mA (corresponding to 0~100%)	Output=gain ×(input-bias) (result confined to 0~100%)			
10~0V or 20~0mA (corresponding to 0~100%)	Output=gain ×[-(input-bias)] + 100% (result confined to 0~100%)			

Input	Calculation formula for output	Basic curve	Bias=10.00%	Gain=200.0%
0~10V (corresponding to -100~100%, with 5V at the center)	Output=gain×2× [(input-bias)-50%] (result confined to -100~100%)			
10~0V (corresponding to -100~100%, with 5V at the center)	Output=gain×(-2)× [(input-bias)-50%] (result confined to -100~100%)			
-10~10V or -20~20mA (corresponding to -100~100%)	Output=gain×(input-bias) (result confined to -100~100%)			
10~-10V or 20~-20mA (corresponding to -100~100%)	Output=gain×[-(input-bias)] (result confined to -100~100%)			
2~10V or 4~20mA (corresponding to 0~100%)	Output=gain×[5/4× (input-bias)-25%] (result confined to 0~100%)			
10~2V or 20~4mA (corresponding to 0~100%)	Output=gain×[-5/4× (input-bias)+125%] (result confined to 0~100%)			

 “Zero-point threshold” and “zero-point hysteresis error” prevent the analog input signal fluctuating around the zero point. For example, setting the former to 10.0% and the latter to 5.0% can bring the hysteresis effect shown in the following diagram.

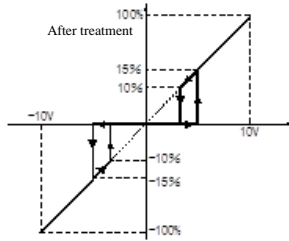

- 📖 Increasing the filtering time slows down the response, but strengthens the immunity to the disturbance. Reducing the filtering time speeds up the response, but weakens the immunity.
- 📖 Analog input is considered to be disconnected if it is lower than the disconnection threshold. The action after the disconnection is determined by Fb-09.

F6-14	AO1 function	Default	0	Change	○
Setting range	See the table of analog output functions below.				
F6-15	AO1 type	Default	0	Change	○
Setting range	0: 0~10V or 0~20mA 1: 2~10V or 4~20mA 2: 5V or 10mA at the center				
F6-16	AO1 gain	Default	100.0%	Change	○
Setting range	0.0~1000.0%				
F6-17	AO1 bias	Default	0.00%	Change	○
Setting range	-99.99~99.99%(10V or 20mA=100%)				
F6-18	AO2 function	Default	2	Change	○
F6-19	AO2 type	Default	0	Change	○
F6-20	AO2 gain	Default	100.0%	Change	○
F6-21	AO2 bias	Default	0.00%	Change	○
Setting range	All settings for AO2 are the same as those for AO1.				

- 📖 Table of analog output functions:

0: Operating frequency (Max. frequency=full-scale value)	13: UP/DOWN value	29: Comparator 2 digital setting
1: Reference frequency (Max. frequency=full-scale value)	14: DC link voltage (1000V=full-scale value)	30: Arithmetic unit 1 digital setting
2: Output current (2 times inverter rated current=full-scale value)	15: Reference frequency after accel/decel (Max. frequency=full-scale value)	31: Arithmetic unit 2 digital setting
3: Output voltage (1.5 times inverter rated voltage=full-scale value)	16: PG detection frequency (Max. frequency=full-scale value)	32: Arithmetic unit 3 digital setting
4: Output capacity (2 times motor rated capacity=full-scale value)	17: Counter error (setpoint count=full-scale value)	33: Arithmetic unit 4 digital setting
5: Output torque (2.5 times motor rated torque=full-scale value)	18: Count percentage (setpoint count=full-scale value)	34: Arithmetic unit 5 digital setting
6: Reference torque (2.5 times motor rated torque=full-scale value)	19: Arithmetic unit 1 output	35: Arithmetic unit 6 digital setting
7: PID feedback value	20: Arithmetic unit 2 output	36: PC analog 1
8: PID reference value	21: Arithmetic unit 3 output	37: PC analog 2
9: PID output value	22: Arithmetic unit 4 output	38: Factory output 1
10: AI1	23: Arithmetic unit 5 output	39: Factory output 2
11: AI2	24: Arithmetic unit 6 output	40: Output frequency(for factory use)
12: PFI	25: Low-pass filter 1 output	41: Keypad POT value(POT: potentiometer)
	26: Low-pass filter 2 output	42: Count value of counter 243: Temperature of radiator 1
	27: Analog multiple switching output	44: Temperature of radiator 2
	28: Comparator 1 digital setting	43, 44: Full amplitude based on 100°C

Option 43 and 44 are effective to the models in parallel only in the table of analog output definition.

Analog output has the following three types:

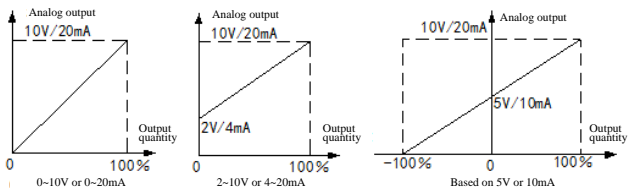

Adjusting the gain and bias can change the measuring range and correct the zero point. The calculation formula is: $Y = X \times \text{gain} + \text{bias}$ (X is any item in the table of analog output functions).

F6-22	PFI frequency corresponding to 100%	Default	10000Hz	Change	○
F6-23	PFI frequency corresponding to 0%	Default	0Hz	Change	○
Setting range	0~50000Hz				
F6-24	PFI filtering time	Default	0.100s	Change	○
Setting range	0.000~10.000s				

The PFI function converts the input pulse frequency to a percentage value and filters it, as shown below. PFI can be used as the frequency reference for cascade synchronous control, or as the PID feedback for constant line speed control.

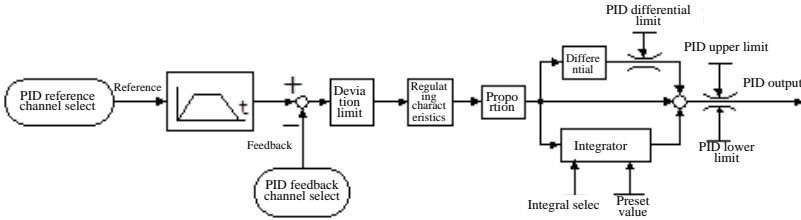

Process PID has three types of correction mode: reference frequency correction prior to accel/decel, reference frequency correction after accel/decel, and torque correction. These correction modes make it convenient to use the inverter in master-slave synchronous control and tension control.

Reference frequency correction prior to accel/decel: PID output is added to the reference frequency prior to accel/decel.

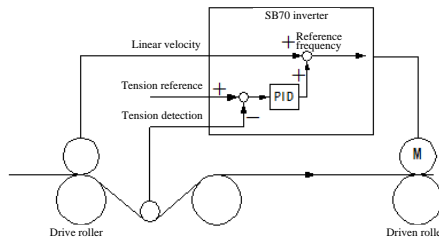

Reference frequency correction after accel/decel: PID output is added to the reference frequency after accel/decel. Unlike the previous correction mode, this mode can also perform the correction during accel/decel.

Torque correction: PID output is added to the reference torque. This correction mode is only valid for torque control. As this correction mode has the fastest response, it can be used for synchronous control of a rigidly-connected system.

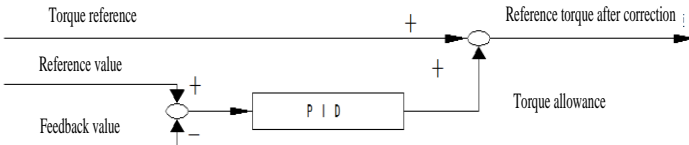

Free PID function: PID acts as a programmable module. Its input and output can be defined separately. PID output can be connected to the analog output.

For position control, process PID can be used as an annular position regulator. Refer to Page 96 for the operation of process PID or frequency correction method.

F7-01	PID reference channel		Default	0	Change	×
Setting range	0: F7-04	1: AI1		2: AI2		
	3: PFI	4: UP/DOWN value		5: Arithmetic unit 1		
	6: Arithmetic unit 2	7: Arithmetic unit 3		8: Arithmetic unit 4		
F7-02	PID feedback channel		Default	0	Change	×

6 Parameter Description

Setting range	0: AI1 AI2	1: PFI	2: $\sqrt{ AI1 }$	3: $\sqrt{ AI2 }$	4: $\sqrt{ AI1-AI2 }$	5: $\sqrt{ AI1 } + \sqrt{ AI2 }$	6: Arithmetic unit 1	7: Arithmetic unit 2	8: Arithmetic unit 3	9: Arithmetic unit 4
F7-03	PID display coefficient				Default	1.000	Change	○		
Setting range	0.010~10.000(only affects FU-13 and FU-14)									
F7-04	PID digital reference				Default	0.0%	Change	○		
Setting range	-100.0~100.0%									

- 📖 PID process adopts normalized input and output, that is, both the input and output range are between -100%~+100%. The input scaling is related to feedback channel, sensor characteristics and analog input setting. The output scaling takes the maximum frequency as 100% for frequency control.
- 📖 There is a filtering section for the PID reference channel and feedback channel, for example, the filtering time for AI1 is F6-03. These filtering sections have influence on the control performance and can be set according to the actual needs.
- 📖 In some machines (such as centrifuges), the square root of the inlet pressure has a linear relationship with the flowrate, therefore, the square root feedback can be used to control the flowrate.
- 📖 F7-03 is used to scale FU-13 and FU-14, making them match the real physical units. It has no influence on the control.

F7-05	Proportional gain 1				Default	0.20	Change	○		
Setting range	0.00~100.00									
F7-06	Integral time 1				Default	20.00s	Change	○		
Setting range	0.01~100.00s									
F7-07	Differential time 1				Default	0.00s	Change	○		
Setting range	0.01~10.00s									
F7-08	Proportional gain 2				Default	0.20	Change	○		
Setting range	0.00~100.00									
F7-09	Integral time 2				Default	20.00s	Change	○		
Setting range	0.01~100.00s									
F7-10	Differential time 2				Default	0.00s	Change	○		
Setting range	0.01~10.00s									
F7-11	PID parameter switching				Default	0	Change	×		
Setting range	0: By digital input 36 3: Arithmetic unit 2									
	1: According to operating frequency 2: Arithmetic unit 1 4: Arithmetic unit 3									
	5: Arithmetic unit 4									

- 📖 Hope800 has two sets of PID parameters: PID parameter 1(F7-05, F7-06, F7-07) and PID parameter 2(F7-08, F7-09, F7-10). They can be switched mutually by the digital input 36. They can also be

smoothly switched according to the operating frequency or the arithmetic unit output, particularly suitable for the winding control where the winding diameter changes greatly.

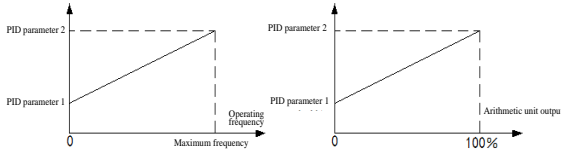

- 📖 Principle of PID parameter regulation: first raise the proportional gain from a smaller value (e.g. 0.20) until the feedback signal starts oscillating, then lower it by 40~60% to stabilize the feedback signal; reduce the integral time from a larger value (e.g. 20.00s) until the feedback signal starts oscillating, then raise it by 10~50% to stabilize the feedback signal. Differential action can be introduced if there is a high requirement for overshoot and dynamic error.

F7-12	Sampling period	Default	0.010s	Change	○
Setting range	0.001~10.000s				

- 📖 It should be generally set to a value five to ten times smaller than the response time of the controlled object.

F7-13	Error limit	Default	0.0%	Change	○
Setting range	0.0~20.0% (PID setpoint=100%)				

- 📖 When the error of the setpoint and feedback is less than the error limit, PID stops its regulation and the output remains constant. This function eliminates frequent actions during the control. See the following diagram.

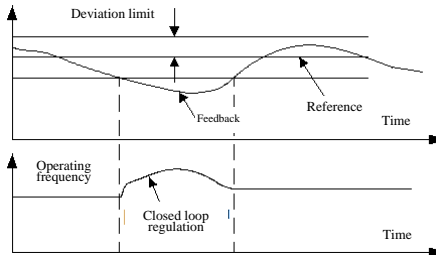

F7-14	Setpoint up/down time	Default	0.00s	Change	○
Setting range	0.00~20.00s				

- 📖 This parameter enables the setpoint to increase and decrease smoothly, thus reducing the impact generated at the moment PID is introduced.

F7-15	PID regulation characteristic	Default	0	Change	×
Setting range	0: Positive 1: Negative				



- 📖 “Positive” means when the setpoint is increased the speed is required to be increase, for example, in heating control; while “negative” means when the setpoint is increased the speed is required to be

Setting range	Units digit: PLC cycle mode 0: PLC operation disabled 1: N cycles(cycle number decided by F8-02)+stop 2: N cycles+final stage speed (cycle number decided by F8-02) 3: Continuous cycle					
	Tens digit: PLC restart mode 0: Restart from the first stage 1: Restart from the frequency of the interrupted stage 2: Restart from the operating frequency at the moment of interruption					
	Hundreds digit: Whether to save PLC status parameters after power-off 0: Not store 1: Store					
	Thousands digit: Unit of time for each stage 0: Second 1: Minute					
F8-01	PLC mode		Default	00	Change	×
Setting range	Units digit: PLC mode/stage number 0: 1×48, 1 mode(mode 0), 48 stages 1: 2×24, 2 modes(mode 0~1), 24 stages for each mode 2: 3×16, 3 modes(mode 0~2), 16 stages for each mode 3: 4×12, 4 modes(mode 0~3), 12 stages for each mode 4: 6×8, 6 modes(mode 0~5), 8 stages for each mode 5: 8×6, 8 modes(mode 0~7), 6 stages for each mode					
	Tens digit: PLC mode select 0: Binary code select 1: Direct select 2: Mode 0 3: Mode 1 4: Mode 2 5: Mode 3 6: Mode 4 7: Mode 5 8: Mode 6 9: Mode 7					
F8-02	PLC cycle number		Default	1	Change	×
Setting range	1~65535					
F8-03~ F8-97	Stage 1 setting and accel/decel setting		Default	00	Change	○
	Units digit: Direction 0: Forward 1: Reverse					
	Tens digit: Accel/decel time select					
	0: Accel/decel 1 4: Accel/decel 5	1: Accel/decel 2 5: Accel/decel 6	2: Accel/decel 3 6: Accel/decel 7	3: Accel/decel 4 7: Accel/decel 8		
F8-04~ F8-97	Stage 1 time		Default	0.0	Change	○
	Setting range: 0.0~6500.0 (second or minute). The time unit is determined by the thousands digit of F8-00.					

 The settings for stages 2~48 are similar to that for stage 1. The default value of the multistep frequency n equals its respective stage number. Refer to the following table.

n	1	2	3	4	5	6	7	8
Stage n setting	F8-03	F8-05	F8-07	F8-09	F8-11	F8-13	F8-15	F8-17
Stage n time	F8-04	F8-06	F8-08	F8-10	F8-12	F8-14	F8-16	F8-18
Multistep frequency n	F4-18	F4-19	F4-20	F4-21	F4-22	F4-23	F4-24	F4-25
n	9	10	11	12	13	14	15	16

Stage n setting	F8-19	F8-21	F8-23	F8-25	F8-27	F8-29	F8-31	F8-33
Stage n time	F8-20	F8-22	F8-24	F8-26	F8-28	F8-30	F8-32	F8-34
Multistep frequency n	F4-26	F4-27	F4-28	F4-29	F4-30	F4-31	F4-32	F4-33
n	17	18	19	20	21	22	23	24
Stage n setting	F8-35	F8-37	F8-39	F8-41	F8-43	F8-45	F8-47	F8-49
Stage n time	F8-36	F8-38	F8-40	F8-42	F8-44	F8-46	F8-48	F8-50
Multistep frequency n	F4-34	F4-35	F4-36	F4-37	F4-38	F4-39	F4-40	F4-41
n	25	26	27	28	29	30	31	32
Stage n setting	F8-51	F8-53	F8-55	F8-57	F8-59	F8-61	F8-63	F8-65
Stage n time	F8-52	F8-54	F8-56	F8-58	F8-60	F8-62	F8-64	F8-66
Multistep frequency n	F4-42	F4-43	F4-44	F4-45	F4-46	F4-47	F4-48	F4-49
n	33	34	35	36	37	38	39	40
Stage n setting	F8-67	F8-69	F8-71	F8-73	F8-75	F8-77	F8-79	F8-81
Stage n time	F8-68	F8-70	F8-72	F8-74	F8-76	F8-78	F8-80	F8-82
Multistep frequency n	F4-50	F4-51	F4-52	F4-53	F4-54	F4-55	F4-56	F4-57
n	41	42	43	44	45	46	47	48
Stage n setting	F8-83	F8-85	F8-87	F8-89	F8-91	F8-93	F8-95	F8-97
Stage n time	F8-84	F8-86	F8-88	F8-90	F8-92	F8-94	F8-96	F8-98
Multistep frequency n	F4-58	F4-59	F4-60	F4-61	F4-62	F4-63	F4-64	F4-65

-  The simple PLC function allows the automatic switching of reference frequencies according to the preset run time, thus realizing the automation of the production process.
-  PLC restart mode is determined by the tens digit of F8-00. When PLC operation is interrupted (failure or stop), it can restart from the first stage, from the frequency of the interrupted stage, or from the operating frequency at the moment of interruption. Refer to the following diagrams. The start mode is determined by F1-19.
-  In all diagrams in this section, f_n represents stage n 's multistep frequency n , a_n and d_n represent stage n 's accel and decel time respectively, and T_n stands for stage n 's time. $n=1\sim 48$.

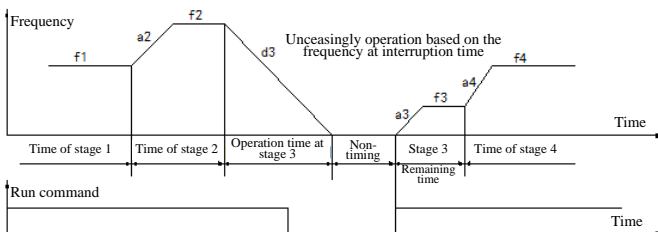

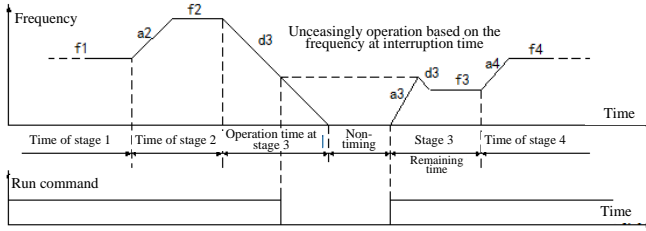

- 📖 PLC status can be stored when power is off, so that it can continue running from the stop status. For example, the unfinished operation of the previous day can be continued when you turn on the power the next day.
- 📖 PLC status will be automatically reset when F8-00, F8-01 or F8-02 is modified.
- 📖 Hope800's multiple PLC modes can be used to control the manufacture of different product models. For example, if a cement plant manufactures cement columns of six sizes, and each size needs an eight-stage of PLC operation, then the units digit of F8-01 can be set to 4(6 modes, 8 stages for each mode).
- 📖 Switching PLC modes during running will takes effect after the stop. The maximum mode number available is determined by the units digit of F8-01.
- 📖 The PLC modes and the stage number for each mode are listed in the table below.

1 mode×48 stages	Mode 0							
Stages contained in each mode	Stage 1~48							
2 modes×24 stages	Mode 0				Mode 1			
Stages contained in each mode	1~24				25~48			
3 modes×16 stages	Mode 0		Mode 1		Mode 2			
Stages contained in each mode	1~16		17~32		33~48			
4 modes×12 stages	Mode 0		Mode 1		Mode 2		Mode 3	
Stages contained in each mode	1~12		13~24		25~36		37~48	
6 modes×8 stages	Mode 0	Mode 1	Mode 2	Mode 3	Mode 4	Mode 5		
Stages contained in each mode	1~8	9~16	17~24	25~32	33~40	41~48		
8 modes×6 stages	Mode 0	Mode 1	Mode 2	Mode 3	Mode 4	Mode 5	Mode 6	Mode 7
Stages contained in each mode	1~6	7~12	13~18	19~24	25~30	31~36	37~42	43~48

- 📖 Select PLC mode by binary codes according to the following table:

Digital input 27 (PLC mode select 3)	Digital input 26 (PLC mode select 2)	Digital input 25 (PLC mode select 2)	PLC mode selected
0	0	0	Mode 0
0	0	1	Mode 1
0	1	0	Mode 2
0	1	1	Mode 3
1	0	0	Mode 4
1	0	1	Mode 5

6 Parameter Description

1	1	0	Mode 6
1	1	1	Mode 7

Select PLC mode directly according to the following table, where X1~X7 are set to PLC mode select 1~7(see digital input 25~31) respectively.

X7	X6	X5	X4	X3	X2	X1	PLC mode selected
0	0	0	0	0	0	0	Mode 0
-	-	-	-	-	-	1	Mode 1
-	-	-	-	-	1	0	Mode 2
-	-	-	-	1	0	0	Mode 3
-	-	-	1	0	0	0	Mode 4
X7	X6	X5	X4	X3	X2	X1	PLC mode selected
-	-	1	0	0	0	0	Mode 5
-	1	0	0	0	0	0	Mode 6
1	0	0	0	0	0	0	Mode 7

Each stage of PLC operation has its own multistep frequency (acting as the reference), run time, run direction and accel/decel time. If you don't want a certain stage, set the run time of that stage to zero.

The following diagram illustrates the operation process of mode 0 (units digit of F8-01 equals zero).

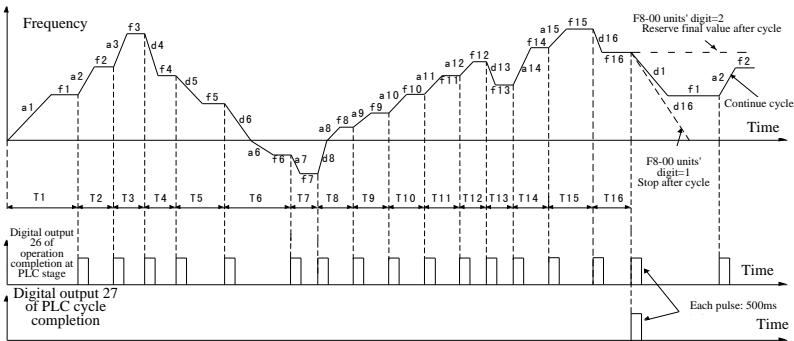

When the digital input 23 is valid, PLC operation pauses; when it is invalid, PLC operation restarts from the stage before the pause (start mode is determined by F1-19), as shown below.

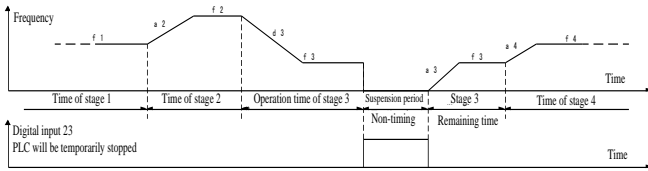

- 📖 When digital input 22 is valid, the inverter enters the runs mode with a lower priority(refer to F0-01); when it is invalid, PLC operation resumes.
- 📖 If digital input 24 is valid in the standby state, then parameters concerning the PLC run stage, cycled number and run timing are reset.
- 📖 Related digital outputs: digital output 24, 25, 26, 27, and 61~68.
- 📖 Related monitored parameters: FU-21~FU23.

6.10 F9: Wobble frequency, counter, meter-counter and zero-servo





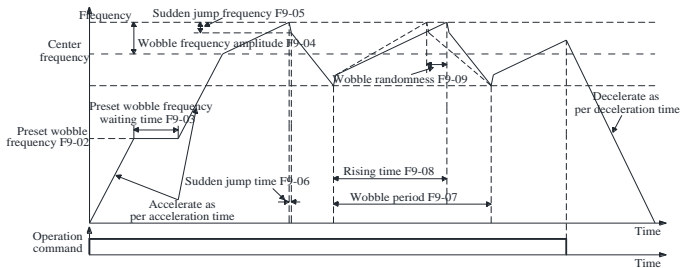

F9-00	Wobble frequency injection mode	Default	0	Change	×
Setting range	0: Disabled 1: Auto injection 2: Manual injection				
F9-01	Wobble amplitude control	Default	0	Change	×
Setting range	0: Center frequency=100% 1: Max. frequency=100%				
F9-02	Preset wobble frequency	Default	0.00Hz	Change	○
Setting range	F0-08~F0-07				
F9-03	Preset wobble frequency waiting time	Default	0.0s	Change	○
Setting range	0.0~3600.0s				
F9-04	Wobble frequency amplitude	Default	0.0%	Change	○
Setting range	0.0~50.0%(center or Max. frequency=100%)				
F9-05	Sudden jump frequency	Default	0.0%	Change	○
Setting range	0.0~50.0%(actual wobble frequency amplitude=100%)				
F9-06	Sudden jump time	Default	0ms	Change	○
Setting range	0~50ms				
F9-07	Wobble period	Default	10.0s	Change	○

Setting range	0.1~1000.0s				
F9-08	Rising time	Default	50.0%	Change	○
Setting range	0.0~100.0%(F9-07=100%)				
F9-09	Wobble randomness	Default	0.0%	Change	○
Setting range	0.0~50.0%(F9-07=100%)				
F9-10	Wobble restart and power-off setting	Default	00	Change	×
Setting range	Units digit: Wobble restart mode after stop 0: Smooth restart 1: Restart from zero				
	Tens digit: Whether to save the wobble frequency status after power-off 0: Save 1: Not save				



- 📖 Wobble function: the process of forming spindle is superimposed by two independent movements, including constant-speed rotation movement and reciprocating movement. Superimposed by these two independent movements, yarn will form a rhombic net track. If speed of these two movements is constant, bumps will be formed at the intersection of yarns. To disorganize the intersection of each layer, speed of reciprocating movement shall be changed constantly. Wobble function is specially designed for winding yarns; it ensures that the yarns are wound around the spindle smoothly and evenly.
- 📖 Wobble function is only valid for V/F control. It becomes invalid automatically in vector control, jog and PID closed-loop operation.
- 📖 The typical wobble operation is shown in the diagram below.

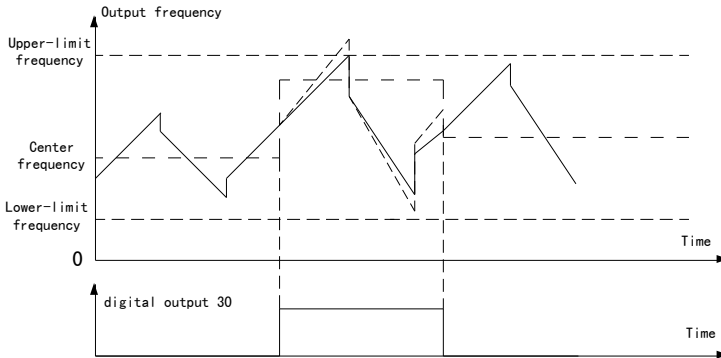

- 📖 When F9-00=1, the inverter first accelerates to F9-02, waits for a period of time (F9-03)(or waits until the digital input 53 becomes valid if F9-00=2), and then reaches the center frequency. After that, it begins the wobble operation according to the settings of F9-04~F9-08 and keeps running until receiving the stop command.
- 📖 The source of the center frequency is the reference frequency for common operation, multi-speed operation and PLC operation.
- 📖 F9-04 should not set too high. That will cause motor overheating. F9-04 is normally set to 0.5~2Hz.
- 📖 F9-05 is used to overcome the actual speed lag caused by the inertia. It is only used when there is a relatively large inertia of the grooved drum.

-  F9-06 sets the time the sudden jump frequency spends.
-  F9-07 sets the time for a complete wobble cycle.
-  F9-08 sets the time for the rising edge. Actual rising time=wobble period×rising time. Actual falling time=wobble period×(1-rising time).
-  When F9-09 is not equal to zero, the actual rising time will vary randomly within a certain range, while the wobble period remain unchanged. The function of random wobble can prevent the stacking of some high-elasticity fibers when they are wound.
-  F9-10 selects the wobble restart mode.
-  Digital input 54: If F9-00=1, the inverter runs at the preset frequency; if F9-00=2, the wobble frequency is disabled and the inverter runs at the center frequency.
-  Digital output 30: If the center frequency or wobble amplitude is set too high and the wobble frequency goes beyond the upper- or lower-limit frequency, the wobble amplitude will be reduced automatically to make the wobble frequency fall within the range between upper- and lower-limit frequency, as shown below.



-  The wobble frequency is only valid in stable operation. If the center frequency changed during the wobble operation, the wobble frequency becomes invalid automatically until the stable operation resumes.
-  When swing frequency function is recommended, F2-09 (vibration damping) should be set to 0.

F9-11	Counter UP command select	Default	57	Change	<input type="radio"/>
Setting range	Refer to the table of digital output functions in Section 6.6.				
F9-12	Counter DOWN command select	Default	58	Change	<input type="radio"/>
Setting range	Refer to the table of digital output functions in Section 6.6.				
F9-13	Counter preset value	Default	0	Change	<input type="radio"/>
Setting range	0~65535				
F9-14	Setpoint count	Default	10000	Change	<input type="radio"/>
Setting range	F9-15~65535				
F9-15	Designated count	Default	0	Change	<input type="radio"/>

Setting range	0~F9-14				
F9-16	Counter frequency-dividing coefficient	Default	1	Change	○
Setting range	1~65535				

- 📖 Hope800's counter can conduct high-speed UP/DOWN counting, with the highest frequency reaching 300kHz if an encoder interface is adopted, 50kHz if a PFI terminal is adopted and 500Hz if a common terminal is used.
- 📖 The value in the counter can be stored after power-off and is used as the initial value for the next counting.
- 📖 Digital inputs 50 and 51 can preset or clear the counter. For the function of the counter, see the following diagram.

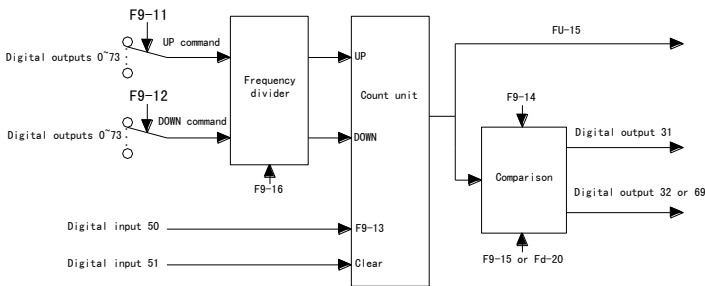

Note: In quadrature counting mode (Fd-19=1), encoder channels A and B are fixed as the UP and DOWN command channels.

📖 F9-11, F9-12:

- When digital outputs 34~36 are selected, the input signal is affected by F4-11;
- Selecting the digital outputs 57 and 58 can realize high-speed counting, with the highest input frequency reaching 300kHz;
- Selecting the digital output 59 can also realize high-speed counting, with the highest input frequency reaching 50kHz;
- When other digital outputs are selected, the sampling time is 1ms.

📖 F9-13 is used for calculation of FU-34 and for presetting the counter when the digital input 50 is valid.

📖 When the count reaches F9-14, the digital output 31 becomes valid, and when the next UP count pulse arrives, the digital output 31 becomes invalid.

📖 When the count reaches F9-15, the digital output 32 becomes valid, and when the pulse number reaches F9-14+1, the digital output 32 becomes invalid.

Example: If F9-11=34(X1), F9-14=9, F9-15=4, and Fd-20=6, then the digital outputs 32, 69 and 31 become valid when the input pulse number of X1 reaches 4, 6 and 9 respectively. When the next pulse arrives, digital output 31, 32 and 69 becomes invalid simultaneously. Refer to the following diagram.

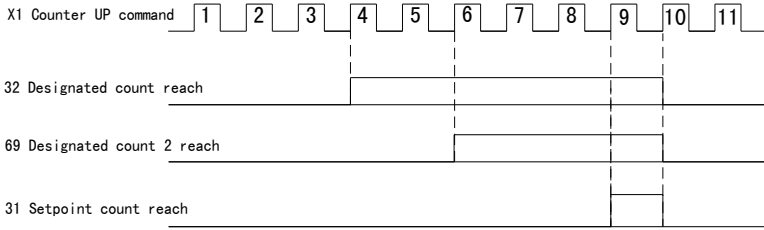

F9-16: count after combining input pulse and combine one count pulse via F9-16 pulse.

Related monitored parameters include FU-15, FU-34 and related analog outputs include 17 and 18. They can be connected to the analog output, arithmetic unit and PID feedback. Their functions are shown as below.

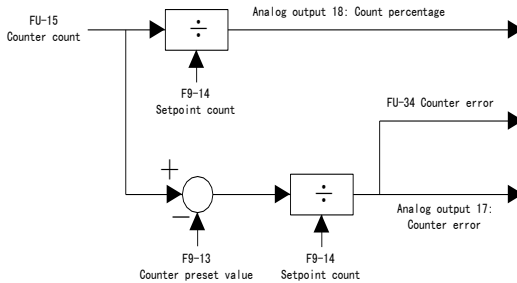

F9-17	Meter-counter input command select	Default	0	Change	<input type="radio"/>
Setting range	Refer to the table of digital output functions in Section 6.6.				
F9-18	Meter-counter setpoint length	Default	1000m	Change	<input type="radio"/>
Setting range	0~65535m				
F9-19	Meter-counter pulse number per meter	Default	100.0	Change	<input type="radio"/>
Setting range	0.1~6553.5				

F9-17:

- When digital outputs 34~46 are selected, the input signal is affected by F4-11.
- Selecting digital outputs 57 and 58 can realize high-speed meter counting, with the highest input frequency reaching 300kHz.
- Selecting the digital output 59 can also realize high-speed meter counting, with the highest input frequency reaching 50kHz.
- The sampling time is 1ms when other digital outputs are selected.

When FU-16 reaches F9-18, the digital output 33 becomes valid.

When the digital input 52 is valid, FU-16 is cleared.

F9-20	Zero-servo control	Default	0	Change	<input type="checkbox"/>
--------------	---------------------------	---------	---	--------	--------------------------

Setting range	0: Invalid 1: Always valid 2: Conditionally valid(selected by digital input 49)
F9-21	Zero-speed level Default 30r/min Change ×
Setting range	0~120r/min
F9-22	Zero-servo ending level Default 10 Change ○
Setting range	1~10000 pulse(s)
F9-23	Zero-servo control gain Default 1.00 Change ×
Setting range	0.00~50.00

- 📖 Zero-servo is only valid for PG vector control.
- 📖 Zero-servo is enabled when F9-20=1 or 2 and the digital input 49 is valid.
- 📖 With zero-servo being enabled, when the reference frequency equals zero and the motor decelerates to F9-21, zero-servo position control begins.
- 📖 When the zero-servo position error is less than F9-22, the digital output 23 is valid, otherwise it's invalid. Refer to the following diagram for zero-servo control sequence.

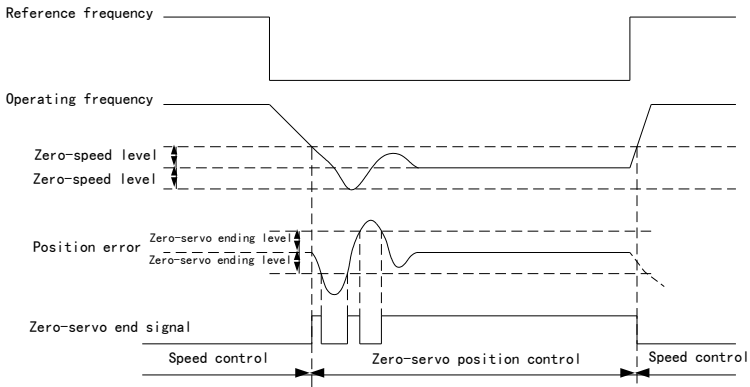

- 📖 Zero-servo can only adopt the quadrature encoder. The pulse number set by F9-22 refers to the total number of edges (both rising and falling) of the quadrature encoder's A and B signals.
- 📖 The response characteristic of zero-servo control can be adjusted by F9-23. Note: adjust the performance of the ASR speed loop first and then the zero-servo control gain.

F9-24	Position control number giving Default 0 Change ○
Setting range	-32768~32767

- 📖 Position control is achieved mainly based on a 32-digit bipolar counter 2 and process PID as shown in the figure below:

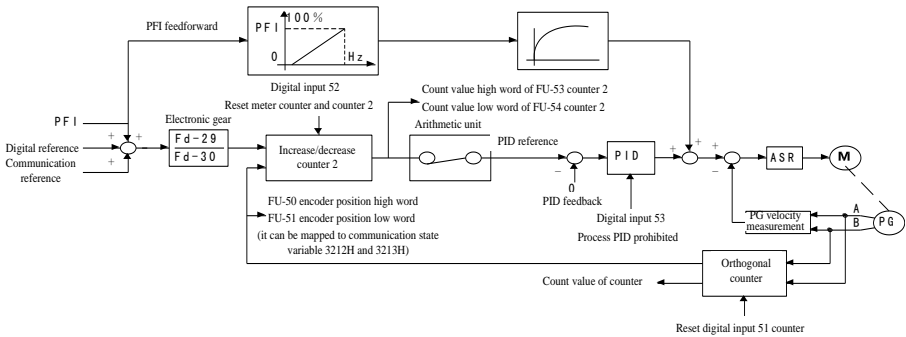

- Three ways of position setting: pulse signal (input pulse sequence of the PFI terminal), digital setting (F9-24) and communication setting (analog quantity 1 of the upper computer), the latter two are only read once at the moment of starting, namely, change of the two settings will not take effect during operation and it will work when restarted.
- When selecting pulse sequence for the position setting, the input of the meter counter must be "59: PFI terminal state", namely, F9-17=59; besides, the feedforward gain of position setting and filtering adjustment can be achieved by the PFI gain and filtering time. It should be noted that the frequency setting should select the frequency correction mode when the PFI and PID work at front/back of the slope.
- When selecting PFI for the position setting, the position setting direction can be determined by the multifunctional digital input "56: reverse direction of the PFI position setting".
- Range of the digital and communication settings: -32768~32767. Directly use the process PID control to form position loop and take the PID output connected by an arithmetic unit as the speed given, then form a speed closed loop together with speed feedback, making double closed loops.
- Three settings are in the form of accumulation internally and when one is used, the other two should be guaranteed to be 0.
- The electronic gear can amplify or shrink the position setting without truncation error. See the page 107 for details.
- The counter 2 is an up-and-down counter. In its interior, the increment count input is fixed to the position setting after handing of the electronic gear and the decrement count input is fixed to 4 times of the frequency quadrature count value of the quadrature encoder, which is the position feedback. At the instant of the converter starting, the converter reads out the position setting and adds it to the counter 2 (PFI is added to the counter 2 in real time). Then the feedback will carry out decrement to the counter 2 and the count value of the counter 2 is the positional deviation.
- When applying to the communication position setting, the three processes that are transmitted to the converter by an upper computer are: master control word (3200H), frequency setting (3201H) and position setting (3202H, namely, analog quantity 1 of the upper computer and see the page 106 for details); the return content includes: major status word (3210H), operation frequency (3211H), encoder position high word (3212H) and encoder position low word (3213H), with the latter two mapped by arithmetic unit 1 and 2. See the page 113 and page 116 for details.

- 📖 The frequency converter is controlled by a PG vector. If there is PG V/F control meeting requirements, the latter is preferred.
- 📖 When the digital input, "51: counter-reset", is effective. Reset the FU-15 "count value of the counter" and the position feedback, that's to say, the FU-50 "encoder position high word" and FU-51 "encoder position low word" are reset at the same time. See the page 122 for details.
- 📖 When the digital input, "52: meter counter and counter 2 reset", is effective. Reset the meter counter and counter 2 at the same time, that's to say, the FU-53 "high word of counter 2 count value" and FU-54 "low word of the counter 2 count value" are reset at the same time. See the page 122 for details.

6.11 FA: Motor parameters

FA-00	Auto-tuning	Default	00	Change	×
Setting range	11: Standstill auto-tuning		22: No-load auto-tuning		
FA-01	Motor rated power	Default	Depends on model	Change	×
Setting range	0.40~1100.00kW/0.4~1200.0kW				
FA-02	Pole number	Default	4	Change	×
Setting range	2~48				
FA-03	Motor rated current	Default	Depends on model	Change	×
Setting range	0.5~1200.0A				
FA-04	Motor rated frequency	Default	50.00Hz	Change	×
Setting range	1.00~650.00Hz				
FA-05	Motor rated speed	Default	Depends on model	Change	×
Setting range	125~4000r/min				
FA-06	Motor rated voltage	Default	380V	Change	×
Setting range	150~500V, default 380V				

- 📖 Be sure to input the motor nameplate parameters FA-01~FA-06 before running the inverter.
- 📖 **FA-00=11:** The stator resistance, leakage inductance and rotor resistance are measured. It is recommended to input the no-load current before auto-tuning.
- FA-00=22:** Besides the parameter measured in standstill auto-tuning, mutual inductance, no-load current and iron core saturation coefficient are measured. The beginning of the no-load auto-tuning process comprises the standstill auto-tuning process.
- 📖 **Attentions on auto-tuning:**
 1. The motor nameplate parameters must be set before auto-tuning, or the motor may be damaged.
 2. The capacity level of the motor should match that of the inverter, and the rated current of the motor should not be less than 1/4 of that of the inverter.

3. When the motor rated capacity is changed, the motor parameters determined by the model will restore to the factory settings.
4. Auto-tuning must be conducted again when the motor or output cable is replaced.
5. To perform the auto-tuning, the keypad needs to be set as the command source.
6. Verify the following items before the no-load auto-tuning: the motor is disconnected from its mechanical load; the motor can accelerate to 80% of the base frequency; the mechanical braking device is released; and in the case where an elevator is used, the mechnacial load is disconnected from the motor.

 Tips on auto-tuning operation:

1. The motor nameplate parameters (FA-01~FA-06) must be input correctly, particularly when vector control is adopted, or the control performance of the inverter will be affected.
2. Before the no-load auto-tuning, set F2-12 and F2-13 correctly and choose the appropriate accel/decel time so that no overcurrent/overvoltage occurs during acceleration and deceleration.
3. Confirm the motor is in standstill, set FA-00 correctly, and press  to run the motor.
4. The motor stops after the auto-tuning is completed. The results of the measurement are recorded in corresponding motor parameters and the value of FA-00 becomes 00 automatically.

 The motor may turn slightly during the standstill auto-tuning.

FA-07	Motor no-load current	Default	Depends on model	Change	×
Setting range	0.1A~FA-03				
FA-08	Motor stator resistance	Default	Depends on model	Change	○
Setting range	0.00~50.00%				
FA-09	Motor leakage reactance	Default	Depends on model	Change	○
Setting range	0.00~50.00%				
FA-10	Motor rotor resistance	Default	Depends on model	Change	○
Setting range	0.00~50.00%				
FA-11	Motor mutual reactance	Default	Depends on model	Change	○
Setting range	0.0~2000.0%				
FA-12	Motor core saturation coefficient 1	Default	1.300	Change	×
Setting range	1.000~1.500(saturation coefficient corresponding to 50% of flux)				
FA-13	Motor core saturation coefficient 2	Default	1.100	Change	×
Setting range	1.000~FA-12(saturation coefficient corresponding to 75% of flux)				
FA-14	Motor core saturation coefficient 3	Default	0.900	Change	×

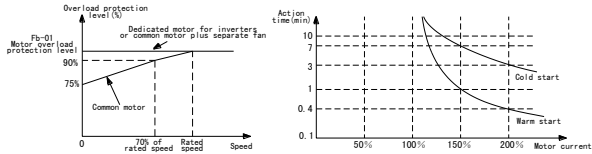

When the motor overload protection takes effect, the motor can continue to run only after it is cooled.

Caution: The motor overload protection function is only applicable to applications where one inverter drives one motor. For applications where one inverter controls more than one motor, please install a thermal protector on each motor.

Fb-03	Motor load overweight protection	Default	00	Change	×
Setting range	Units digit: Overweight detection mode 0: Always detect 1: Detect only in constant-speed operation				
	Tens digit: Action to overweight 0: No action 1: Continue running with an alarm 2: Coast to a stop due to fault				
Fb-04	Motor load overweight detection level	Default	130.0%	Change	×
Setting range	20.0~200.0%(motor rated current=100%)				
Fb-05	Motor load overweight detection time	Default	5.0s	Change	×
Setting range	0.0~30.0s				

When the motor current exceeds Fb-04 and lasts for a period of time longer than Fb-05, the motor acts according to the setting of Fb-03. This function is used to detect whether the mechanical load is abnormal and causes an excessively large current.

Fb-06	Inverter underload protection	Default	0	Change	×
Setting range	0: No action 1: Continue running with an alarm 2: Coast to a stop due to fault				
Fb-07	Inverter underload protection level	Default	30.0%	Change	×
Setting range	0.0~100.0%(inverter rated current=100%)				
Fb-08	underload protection detection time	Default	1.0s	Change	×
Setting range	0.0~100.0s				

When the output current is lower than Fb-07 and lasts for a period of time longer than Fb-08, the inverter acts according to the setting of Fb-06. This function can timely detect such faults as no-load turning or water pump, breaking of conveying belt and opening of contactor on the motor side.

Do not enable this protection function during the inverter no-load test.

Fb-09	Analog input disconnection action	Default	0	Change	×
Setting range	0: No action 1: Run at the average frequency within 10s before disconnection, with an AL.Aco alarm 2: Run at the frequency set by Fb-10, with an AL.Aco alarm 3: Coast to a stop, with an Er.Aco alarm				

Fb-10	Frequency after analog input disconnection	Default	0.00Hz	Change	○
Setting range	0.00Hz~F0-06				

The analog input is considered to be disconnected when the inverter detects that the analog input signal is lower than the disconnection threshold.

Related parameters: F6-06 and F6-13.

Fb-11	Other protection actions	Default	0022	Change	×
Setting range	Units digit: inverter input phase loss protection 0: No action 1: Continue running with an alarm 2: Coast to a stop due to fault				
	Tens digit: inverter output phase loss protection 0: No action 1: Continue running with an alarm 2: Coast to a stop due to fault				
	Hundreds digit: keypad disconnection protection 0: No action 1: Continue running with an alarm 2: Coast to a stop due to fault				
	Thousands digit: parameter store failure protection 0: Continue running with an alarm 1: Coast to a stop due to fault				

Inverter input phase loss is judged by the DC link voltage ripples it causes. In no-load or slight-load operation, the input phase loss may not be able to be detected. When there is great imbalance among the three input phases or great oscillation with the output, input phase loss will also be detected.

When the inverter has the fault of output phase loss, the motor will run in single phase, which will lead to both a greater current and torque pulsation. Output phase loss protection prevents the motor and its mechanical load being damaged.

When the output frequency or current is very low, the output phase loss protection will be invalid.

Fb-12	Accel overcurrent stall prevention	Default	1	Change	×
Setting range	0: Invalid 1: Valid				
Fb-13	Accel overcurrent stall point	Default	150.0%	Change	×
Setting range	10.0~150.0%(inverter rated current=100%)				
Fb-14	Constant-speed overcurrent stall prevention	Default	1	Change	×
Setting range	0: Invalid 1: Valid				
Fb-15	Constant-speed overcurrent stall point	Default	150.0%	Change	×
Setting range	10.0~150.0%(inverter rated current=100%)				
Fb-16	Overvoltage stall prevention	Default	1	Change	×
Setting range	0: Invalid 1: Valid				

Fb-17	Overvoltage stall point	Default	350V 700V 1212V	Change	×
Setting range	220v class: 325~375V, default 350V 380v class: 650~750V, default 700V 690v class: 1125~1300V, default 1212V				

- During acceleration, when Fb-12 is valid and the output current is greater than Fb-13, the acceleration stops temporarily. After the current drops the motor continues to accelerate. See diagram (a) below.
- During constant-speed running, when Fb-14 is valid and the output current is greater than Fb-15, the motor decelerates. After the current drops the motor reaccelerates to the original operating frequency. See diagram(b) below.
- During deceleration, when Fb-16 is valid and the DC link voltage is greater than Fb-17, the deceleration stops temporarily. After the DC link voltage drops to the normal level the motor continues to decelerate. See diagram (c) below.

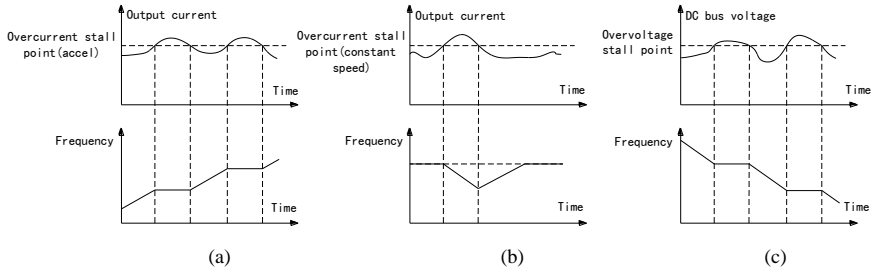

- If stall holding time exceeds 1min during actual operation, the inverter will show "Er.Abb abnormal shutdown failure", which can be shielded by selecting "2: valid with unlimited time".

Fb-18	DC link undervoltage action	Default	0	Change	×
Setting range	0: Coast to a stop and report the undervoltage fault(Er.dcl) 1: Coast to a stop, and restart if the voltage resumes within the time set by Fb-20 or report the undervoltage fault(Er.dcl) if undervoltage time exceeds the time set by Fb-20 2: Coast to a stop, and restart if CPU is still working and detects that the voltage resumes, without reporting the undervoltage fault 3: Decelerate, and accelerate to the reference frequency if CPU is still working and detects that the voltage resumes, without reporting the undervoltage fault.				
Fb-19	DC link undervoltage point	Default	400V	Change	×
Setting range	370~480V, default 400V				
Fb-20	Allowable time for momentary power failure	Default	0.1s	Change	×
Setting range	0.0~30.0s				
Fb-21	Momentary power failure decel time	Default	0.0s	Change	×
Setting range	0.0~200.0s (if Fb-21=0.0, the current decel time is used)				

- The detection of momentary power failure is completed by detecting the DC link voltage. When DC link voltage is less than Fb-19,

if Fb-18=0: The motor coasts to a stop, and the fault of DC link undervoltage is reported;

-  When terminal is the command source and F4-08=0, 1 or 2, if the run command is valid after power-on, then Fb-26 can be used to select whether to start the system immediately.

Fb-27	Built-in braking unit working threshold	Default	680V	Change	○
Setting range	620~720V				

-  Using the braking unit can consume the energy on the braking resistor and make the motor stop quickly. When the DC link voltage exceeds Fb-27, the braking unit will begin working automatically.

Fb-28	Modulation mode	Default	0	Change	○
Setting range	0: Auto(automatically switching between continuous and discontinuous modulation) 1: Continuous				

-  The discontinuous modulation in the auto mode has a lower switching loss but greater harmonics compared with the continuous one.

Fb-29	Carrier frequency	Default	Depends on model	Change	○
Setting range	75~160 kW: 1.1k~8.0 kHz, Default: 2.5kHz 200 kW or more 1.1k~5.0 kHz, Default: 2.0kHz				
Fb-30	Random PWM setting	Default	0%	Change	○
Setting range	0~30%				
Fb-31	Carrier frequency auto adjustment	Default	1	Change	○
Setting	0: Disabled 1: Enabled				

-  Increasing the carrier frequency can lower the motor noise, harmonic current and the heat generated by the motor, but raise the common-mode current, disturbance and the heat generated by the inverter, and decreasing the carrier frequency will lead to the opposite. Therefore, when a silent run is required, you can moderately raise the carrier frequency. If the carrier frequency is higher than the factory setting, the inverter should be derated by 5% for every increment of 1kHz.

-  Fb-30 disperses the spectrum of the carrier frequency and improves the acoustic quality. Lowering this parameter can make the noise less harsh. Fb-30=0% means the carrier frequency is fixed.

-  Fb-31 can automatically regulate the carrier frequency according to the heat sink temperature, output current and output frequency, preventing the inverter from failing due to overheating. The carrier frequency falls automatically if the heat sink temperature and the low-frequency current are too high.

Fb-32	Deadband compensation	Default	1	Change	×
Setting range	0: Disabled 1: Enabled				

-  Deadband compensation can reduce output harmonics and torque ripples; however, it must be disabled when the inverter is used as a power supply.

Fb-33	Space vector angle stop save	Default	0	Change	×
Setting range	0: Not save 1: Save				

-  It is used to maintain synchronization after the synchronous motor stops and restarts, only valid for V/F

control.

Fb-34	Overmodulation	Default	1	Change	×
Setting range	0: Disabled 1: Enabled				

Overmodulation enables the inverter to have a high output voltage which can be near or greater than the power supply voltage, but also causes high torque ripples of the motor. Disabling overmodulation can eliminate the torque ripples and improve the control of such load as grinding machines.

Fb-35	Cooling fan control	Default	0	Change	○
Setting range	0: Stop after standby state lasts 3 minutes 1: Keep running				

In applications where the motor starts/stops frequently, setting Fb-35 to 1 can prevent frequent start/stop of the cooling fan.

Fb-36	Jump frequency 1	Default	0.00Hz	Change	○
Setting range	0.00~625.00Hz				
Fb-37	Jumping width 1	Default	0.00Hz	Change	○
Setting range	0.00~20.00Hz				
Fb-38	Jump frequency 2	Default	0.00Hz	Change	○
Setting range	0.00~625.00Hz				
Fb-39	Jumping width 2	Default	0.00Hz	Change	○
Setting range	0.00~20.00Hz				
Fb-40	Jump frequency 3	Default	0.00Hz	Change	○
Setting range	0.00~625.00Hz				
Fb-41	Jumping width 3	Default	0.00Hz	Change	○
Setting range	0.00~20.00Hz				

Jump frequency prevents the inverter running at the mechanical resonant points.

During acceleration or deceleration, the inverter can run through the jump frequency smoothly (i.e. jump frequency becomes invalid), but can not keep steady-state operation within the jumping width.

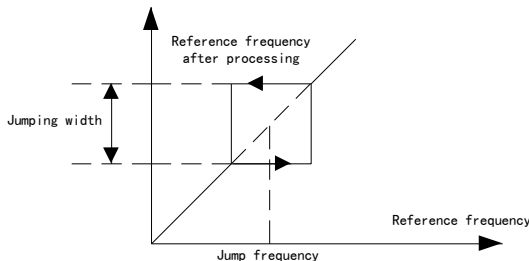

6.13 FC: Keypad operation and display settings

FC-00	Display parameter select	Default	0	Change	○
Setting range	0: All menus 1: User-selected parameters 2: Parameters different from factory settings				

FC-00=1: Only parameters selected by FC-15~FC-46 are displayed. User password is invalid for these parameters. But changing FC-00 needs the user password.

FC-00=2: Only parameters that have different settings from the factory settings are displayed. This facilitates the test and maintenance.

FC-01	Key function and auto lockup	Default	0000	Change	×
Setting range	Units digit: determines which keys are locked. 0: None locked 1: All locked 2: All locked but 3: All locked but 4: All locked but and 5: All locked but and				
	Tens digit: determines the function of 0: Valid only when keypad is the command source 1: Valid when keypad, terminal or communication is the command source. Stops the motor according to preset stop mode. 2: Stops the motor according to preset stop mode when keypad is the command source; makes the motor coast to a stop and give an Er.Abb alarm when any other command source is selected.				
	Hundreds digit: determines the function of (only when keypad is command source) 0: Invalid 1: Valid only in standby state 2: Valid				
	Thousands digit: determines the function of (only when keypad is command source) 0: Common run 1: Jog				

Keys are locked up automatically if no key is pressed within one minute. In monitoring state, pressing + will lock the keys, and pressing + and holding for three seconds will unlock them.

FC-02	Monitored parameter 1 (in run and standby)	Default	1	Change	○
FC-03	Monitored parameter 2 (in run and standby)	Default	-1	Change	○
FC-04	Monitored parameter 3 (in run and standby)	Default	-1	Change	○
FC-05	Monitored parameter 4 (in run and standby)	Default	-1	Change	○
FC-06	Monitored parameter 5 (in run and standby)	Default	-1	Change	○
FC-07	Monitored parameter 6 (in run and standby)	Default	-1	Change	○
FC-08	Monitored parameter 7 (in run and standby)	Default	-1	Change	○
FC-09	Monitored parameter 1 (in run)	Default	0	Change	○
FC-10	Monitored parameter 2 (in run)	Default	2	Change	○
FC-11	Monitored parameter 3 (in run)	Default	4	Change	○
FC-12	Monitored parameter 4 (in run)	Default	-1	Change	○
Setting range	-1~59 Note: -1 indicates null and 0~59 represent FU-00~FU-59 respectively. The minimum value of FC-02 is 0.				

FC-02~FC-08 select(from the FU menu) the parameters to be monitored in both running and standby states.

FC-09~FC-12 select(from the FU menu) the parameters to be monitored only in running state.

FC-13	Speed display coefficient	Default	1.000	Change	○
Setting range	0.001~10.000 FU-05=120×operating frequency ÷pole number×FC-13 FU-06=120×reference frequency ÷pole number×FC-13				

Only used for speed conversion and has no influence on actual speed and motor control.

FC-14	Line speed display coefficient	Default	0.01	Change	○
Setting range	0.01~100.00 FU-11=operating frequency ×FC-14 FU-12=reference frequency ×FC-14				

Only used for line speed conversion and has no influence on actual line speed and motor control.

FC-15 ~ FC-44	User parameters 1~30	Default	-00.01	Change	○
Setting range	-00.01~FU.59(excluding factory parameters Fn) Note: -00.01 indicates null and others represent parameter numbers respectively, for example, F0.01 represents F0-01.				
FC-45	User parameter 31	Default	FC.00	Change	△
FC-46	User parameter 32	Default	F0.10	Change	△

User parameters 1~30 select the parameters the user uses often or concerns about. When FC-00=1, these parameters are displayed.

User parameters 31 and 32 are fixed to be FC-00 and F0-10 respectively; they can not be modified.

Example: F0.01 in FC-15 refers to that the first function of user parameters is F0-01 and then FC-00 should be set as 1. In this way, when entering menu under monitoring state, only F0-01, FC-00 and F0-10 can be seen.

6.14 Fd: Expansion options and functions

Fd-00	Parameter copying	Default	00	Change	×
Setting range	11: Upload parameters from inverter to keypad 22: Download parameters from keypad to inverter 33: Confirm the consistency of keypad parameters with inverter parameters 44: Clear parameters stored in keypad The value of this parameter becomes 00 after the operation.				









This function is very useful in applications where multiple inverters have the same settings.

It is not recommended to use the download function between inverters with different capacity classes.

This function is only valid for keypads (SB-PU70E) with parameter copying function.

Fd-01	PG pulse number per revolution	Default	1024	Change	×
Setting range	1~8192				
Fd-02	PG type	Default	0	Change	×

Setting range	0: Quadrature encoder 1: Single-channel encoder					
Fd-03	PG direction	Default	0	Change	×	
Setting range	0: Positive(direction is positive if phase A of quadrature encoder leads phase B) 1: Negative(direction is positive if phase B of quadrature encoder leads phase A)					
Fd-04	PG disconnection action	Default	2	Change	×	
Setting range	0: No action 1: Alarm (AL.PGo displayed) 2: Coast to a stop due to fault(Er.PGo displayed)					
Fd-05	PG disconnection detection time	Default	1.0s	Change	×	
Setting range	0.1~10.0s					
Fd-06	PG speed ratio denominator	Default	1	Change	×	
Fd-07	PG speed ratio numerator	Default	1	Change	×	
Setting range	1~1000					
Fd-08	PG speed test filtering time	Default	0.005s	Change	○	
Setting range	0.000~2.000s					

-  To use the encoder a encoder interface card (such as SL-PG0) is needed. The wiring of the card is described in detail in Chapter 9.
-  Fd-02: If single-channel encoder is selected, the signal must enter from channel A. Single-channel encoder is not applicable to low-speed operations and operations with both forward and reverse directions.
-  Fd-03: For a single-channel encoder, if positive direction is selected, then FU-35 is always positive, otherwise always negative.
-  PG disconnection: PG is regarded to be disconnected if the reference frequency of the speed regulator is greater than 0.5Hz and the encoder fails to generate a pulse within the time set by Fd-05. The motor act according to the setting of Fd-04. PG disconnection detection is performed only for PG V/F control and PG vector control.
-  In application where the encoder is connected to the motor shaft via speed changing devices such as gears, Fd-06 and Fd-07 must be correctly set. The relationship between the encoder speed and motor speed is: Motor speed=encoder speed×Fd-07÷Fd-06.
-  Fd-08 should not be too large if a high dynamic performance is required.
-  Related monitored parameter: FU-35.
-  Method of verifying the encoder setting: Adopt PG V/F control mode and run the motor in the direction and at the frequency which are allowed by the load, check to see if the direction of FU-35 is consistent with the direction displayed on the keypad, and if the value of FU-35 is close to the reference frequency.

Danger: PG parameters must be set correctly in control modes with PG, otherwise injury to people and damage to equipment may occur. The setting of the encoder direction must be rechecked after the motor cables are rewired.

Fd-09	Expansion digital input terminal X7	Default	0	Change	×
Fd-10	Expansion digital input terminal X8	Default	0	Change	×
Fd-11	Expansion digital input terminal X9	Default	0	Change	×

Fd-12	Expansion digital input terminal X10	Default	0	Change	×
Fd-13	Expansion digital input terminal X11	Default	0	Change	×
Setting range	Refer to the table of digital input functions in Section 6.5.				

 The expansion digital input terminals X7~X11 are located on the expansion board. See Section 9.5.

 The expansion digital input terminal signals are processed by F4-11, too.

 Related monitored parameter: FU-43.

Fd-14	Expansion digital output terminal Y3	Default	0	Change	×
Fd-15	Expansion digital output terminal Y4	Default	0	Change	×
Fd-16	Expansion digital output terminal Y5	Default	0	Change	×
Fd-17	Expansion digital output terminal Y6	Default	0	Change	×
Fd-18	Expansion digital output terminal Y7	Default	0	Change	×
Setting range	Refer to the table of digital output functions in Section 6.6.				

 The expansion digital output terminals Y3~Y7 are located on the expansion board. See Section 9.5.

 Related monitored parameter: FU-44

Fd-19	Counting method	Default	0	Change	×
Setting range	0: Common counting 1: Quadrature counting				

 Using the quadrature counting method can make the UP/DOWN count for quadrature encoder's channels A and B (count up if A leads B and count down if B leads A). Fd-03 can swap channel A with B.

Fd-20	Designated count 2	Default	0	Change	○
Setting range	0~F9-14				

 The function of Fd-20 is the same as that of F9-15.

 Digital output 69 is identical to digital out 32 in function.

Fd-21	Logic unit 5 input 1	Default	0	Change	○
Fd-22	Logic unit 5 input 2	Default	0	Change	○
Fd-23	Logic unit 5 config	Default	9	Change	○
Fd-24	Logic unit 5 output	Default	0	Change	○
Fd-25	Logic unit 6 input 1	Default	0	Change	○
Fd-26	Logic unit 6 input 2	Default	0	Change	○
Fd-27	Logic unit 6 config	Default	9	Change	○
Fd-28	Logic unit 6 output	Default	0	Change	○
Setting range	All settings for logic units 5 and 6 are the same as that for logic unit 1				

 Related digital outputs: 70 and 71.

Fd-29	Electronic gear member settings	Default	1	Change	○
Fd-30	Electronic gear denominator settings	Default	1	Change	○
Setting range	1~65535				

☞ Please correctly set the parameter to prevent the motor revolving speed from significant change and see the page 96 for details.

Fd-31	Air Blower Life Expectancy Settings	Default Value	40000h	Change	×
Setting range	1~65000h				

☞ When the accumulated operation time reaches the air blower life expectancy setting, the digital output terminal function of “72: air blower life expectancy is reached” will be effective. It is suggested to replace an air blower with same model. After replacement, make use of external terminal input of “55: reset the air blower accumulated operation time” to realize zero clearing of the accumulated time of the air blower, besides, the “72: air blower life expectancy is reached” will be invalid.

☞ Relevant parameters: digital input terminal function 55: reset the air blower accumulated operation time;

Digital output terminal function: 72: the air blower life expectancy is reached;

Monitoring parameters: FU-60 “air blower accumulated operation time”.

Fd-32	Sleeping Frequency	Default Value	40.00Hz	Change	○
Setting range	0.00~650.00Hz				
Fd-33	Sleeping waiting time	Default value	60.0s	Change	○
Setting range	0.0~3600.0s				
Fd-34	Wake-up deviation	Default value	100.00%	Change	○
Setting range	0.00~100.00% note: the sleeping function will not work when it is 100%				
Fd-35	Rouse delay time	Default value	0.500s	Change	○
Setting range	0.000~60.000s				

☞ When applying to the process PID, such as the constant-pressure water supply situation, the sleeping function can be used. When the water consumption decreases, the operation frequency is lower than the Fd-32 “sleeping frequency” and the sustainable time is more than Fd-33 “sleeping waiting time”, the process PID enters into sleeping state and the digital input of “73: process PID is in sleeping state” is available; when the feedback quantity is less than the difference value of the PID setting and Fd-34 “wake-up deviation” and the sustainable time is more than Fd-35 “wake-up delay time”, the process PID is waked up and it enters into normal working state. As shown in figure below:

☞ When the process PID sleeping is waked up, the starting method is determined by the Fb-25 “restart from instantaneous stop, self-reset and outage” and F1-19 “starting method”. It is suggested to start from the starting frequency in occasions not allowing reversal.

Relevant digital output function “73: process PID is in sleeping state”, which is applied to start other small-power pumps during sleeping state.

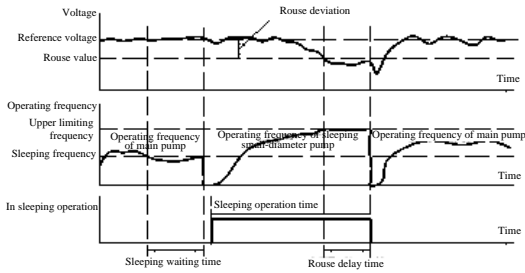

Fd-36	Motor rate current 1	Default value	8.8A	Change	<input type="radio"/>
Fd-37	Motor rated current 2	Default value	8.8A	Change	<input type="radio"/>
Setting range	0.5~1200.0A				

By utilizing “motor rated current 1” and “motor rated current 2” and FA-03 “motor rated current” of general machines, overload protection can be conducted to multiple different motors. The used one is chosen via the multifunctional digital input terminals and sees the table below for choice:

57: Choose 1 for the Motor Rated Current	58: Choose 2 for the Motor Rated Current	Motor Rated Current Value
Invalid	Invalid	FA-03 “motor rated current”
Invalid	Valid	Fd-37 “motor rated current 2”
Valid	×	Fd-36 “motor rated current 1”

Relevant digital input function: “57: choose 1 for the motor rated current” and “58: choose 2 for the motor rated current”, the latter has a higher priority.

6.15 FE: Programmable unit

FE-00	Comparator 1 in-phase input select	Default	0	Change	<input type="radio"/>
Setting range	See the table of analog output functions in Section 6.7.				
FE-01	Comparator 1 opposite-phase input select	Default	0	Change	<input type="radio"/>
Setting range	See the table of analog output functions in Section 6.7.				
FE-02	Comparator 1 config	Default	005	Change	<input type="radio"/>

Setting range	Units digit: sets the functions 0: If in-phase input>opposite-phase input, the comparator outputs 1, otherwise outputs 0 1: If in-phase input<opposite-phase input, the comparator outputs 1, otherwise outputs 0 2: If in-phase input=opposite-phase input(in-phase input-opposite-phase input ≤error band/2), the comparator outputs 1, otherwise outputs 0 3: If in-phase input≠opposite-phase input(in-phase input-opposite-phase input ≤error band/2), the comparator outputs 1, otherwise outputs 0 4: Comparison is invalid, and the output is constant 1 5: Comparison is invalid, and the output is constant 0				
	Tens digit: determines whether to take the absolute value 0: No 1: Yes				
	Hundreds digit: selects the protection function for comparator output 0: No action 1: The motor continues running with an alarm 2: The inverter coasts to a stop due to fault(Er.Co1 or Er.Co2 displayed)				
FE-03	Comparator 1 digital setting	Default	50.0%	Change	○
Setting range	-100.0~100.0%(corresponding to analog output 28)				
FE-04	Comparator 1 error band	Default	5.0%	Change	○
Setting range	0.0~100.0%				
FE-05	Comparator 1 output select	Default	0	Change	○
Setting range	Refer to the table of digital input functions in Section 6.5				
FE-06	Comparator 2 in-phase input select	Default	0	Change	○
FE-07	Comparator 2 opposite-phase input select	Default	0	Change	○
FE-08	Comparator 2 config	Default	005	Change	○
FE-09	Comparator 2 digital setting(corresponding to analog output 29)	Default	50.0%	Change	○
FE-10	Comparator 2 error band	Default	5.0%	Change	○
FE-11	Comparator 2 output select	Default	0	Change	○
Setting range	All settings for comparator 2 are identical to that for comparator 1				

The structure of the comparator is as the following diagram.

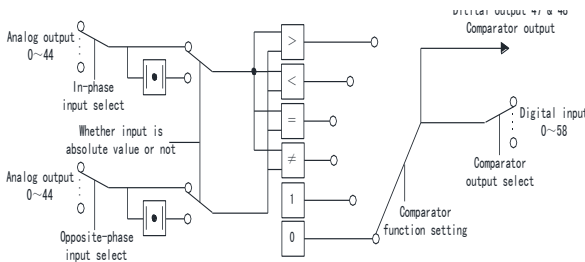

The functions of the comparator are shown in the following diagrams.

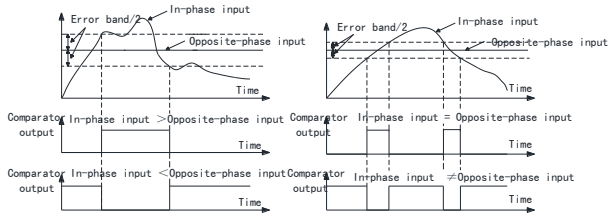

The result of comparison between two signals can be used as the trigger signal of inverter protection actions. Required protection actions can be selected according to hundred digit of "comparator configuration".

FE-12	Logic unit 1 input 1 select	Default	0	Change	○
Setting range	Refer to the table of digital output functions in Section 6.6.				
FE-13	Logic unit 1 input 2 select	Default	0	Change	○
Setting range	Refer to the table of digital output functions in Section 6.6.				
FE-14	Logic unit 1 config	Default	9	Change	○
Setting range	0: AND 1: OR 2: NAND 3: NOR 4: XOR(≠) 5: XNOR(=) 6: Output=input 1 7: Output= ~ input 1 8: Output≡1 9: Output≡0 10: R-S trigger				
FE-15	Logic unit 1 output select				
Setting range	Refer to the table of digital input functions in Section 6.5.				
FE-16	Logic unit 2 input 1 select				
FE-17	Logic unit 2 input 2 select	Default	0	Change	○
FE-18	Logic unit 2 config	Default	9	Change	○
FE-19	Logic unit 2 output select	Default	0	Change	○
FE-20	Logic unit 3 input 1 select	Default	0	Change	○
FE-21	Logic unit 3 input 2 select	Default	0	Change	○
FE-22	Logic unit 3 config	Default	9	Change	○
FE-23	Logic unit 3 output select	Default	0	Change	○
FE-24	Logic unit 4 input 1 select	Default	0	Change	○
FE-25	Logic unit 4 input 2 select	Default	0	Change	○
FE-26	Logic unit 4 config	Default	9	Change	○
FE-27	Logic unit 4 output select	Default	0	Change	○
Setting range	All settings for logic units 2~4 are identical to that for logic unit 1				

The structure of the logic unit is as the following diagram.

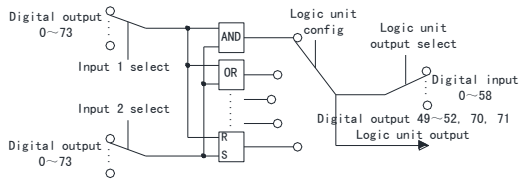

FE-28	Timer 1 input select	Default	0	Change	○
Setting range	Same as F5-00				
FE-29	Timer 1 config	Default	300	Change	○
Setting range	Units digit: type of timer 0: Rising edge delay 1: Falling edge delay 2: Rising and Falling edge delay 3: Pulse function				
	Tens digit: magnification of set time 0: 1 1: 10 2: 100 3: 1000 4: 10000 5: 100000				
	Hundreds digit: output signal setting 0: Output=input 1: Output=~input 2: Output≡1 3: Output≡0 4: AND 5: NAND 6: OR 7: NOR				
FE-30	Timer 1 set time	Default	0ms	Change	○
Setting range	0~40000ms				
FE-31	Timer 1 output select	Default	0	Change	○
Setting range	Refer to the table of digital input functions in Section 6.5.				
FE-32	Timer 2 input select	Default	0	Change	○
FE-33	Timers 2 config	Default	300	Change	○
FE-34	Timer 2 set time	Default	0ms	Change	○
FE-35	Timer 2 output select	Default	0	Change	○
FE-36	Timer 3 input select	Default	0	Change	○
FE-37	Timer 3 config	Default	300	Change	○
FE-38	Timer 3 set time	Default	0ms	Change	○
FE-39	Timer 3 output select	Default	0	Change	○
FE-40	Timer 4 input select	Default	0	Change	○
FE-41	Timer 4 config	Default	300	Change	○
FE-42	Timer 4 set time	Default	0ms	Change	○
FE-43	Timer 4 output select	Default	0	Change	○
Setting range	All settings for timers 2~4 are identical to that for timer 1.				

The structure of the timer is as the following diagram.

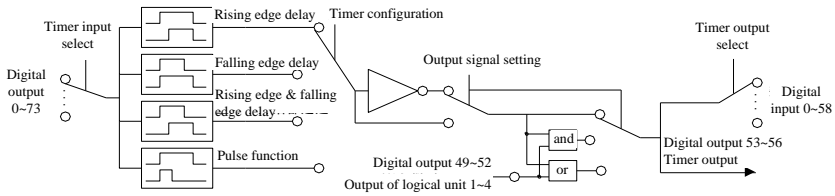

The functions of the timer are shown in the diagrams below.

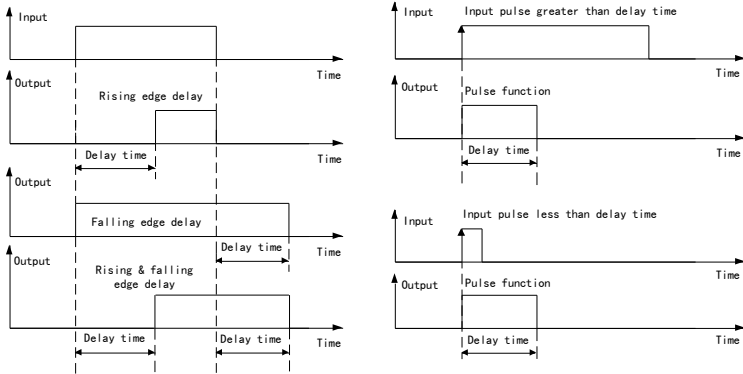



Using the timer can eliminate the signal jitter. Take the function of “rising edge delay” as an example, if the input pulse is shorter than the delay time, no signal will be output.

FE-44	Arithmetic unit 1 input 1 select	Default	0	Change	○
Setting range	Refer to the table of analog output functions in Section 6.7.				
FE-45	Arithmetic unit 1 input 2 select	Default	0	Change	○
Setting range	Refer to the table of analog output functions in Section 6.7.				
FE-46	Arithmetic unit 1 config	Default	0	Change	○
Setting range	0: Input 1+input 2 1: Input 1-input 2 2: Input 1×input 2 3: Input 1÷input 2 4: Take the smaller one of the two inputs 5: Take the larger one of the two inputs 6: Input 1 ×input 2 7: Input 1 ÷input 2 8: Input 1 is output directly(functions as a connection) 9: High value of coder position 10: Low value of coder position				
FE-47	Arithmetic unit 1 digital setting	Default	0.0%	Change	○
Setting range	-100.0~100.0%(corresponding to analog output 30)				
FE-48	Arithmetic unit 2 input 1 select	Default	0	Change	○
FE-49	Arithmetic unit 2 input 2 select	Default	0	Change	○
FE-50	Arithmetic unit 2 config	Default	0	Change	○

FE-51	Arithmetic unit 2 digital setting (corresponding to analog output 31)	Default	0.0%	Change	○
FE-52	Arithmetic unit 3 input 1 select	Default	0	Change	○
FE-53	Arithmetic unit 3 input 2 select	Default	0	Change	○
FE-54	Arithmetic unit 3 config	Default	0	Change	○
FE-55	Arithmetic unit 3 digital setting (corresponding to analog output 32)	Default	0.0%	Change	○
FE-56	Arithmetic unit 4 input 1 select	Default	0	Change	○
FE-57	Arithmetic unit 4 input 2 select	Default	0	Change	○
FE-58	Arithmetic unit 4 config	Default	0	Change	○
FE-59	Arithmetic unit 4 digital setting (corresponding to analog output 33)	Default	0.0%	Change	○
FE-60	Arithmetic unit 5 input 1 select	Default	0	Change	○
FE-61	Arithmetic unit 5 input 2 select	Default	0	Change	○
FE-62	Arithmetic unit 5 config	Default	0	Change	○
FE-63	Arithmetic unit 5 digital setting (corresponding to analog output 34)	Default	0.0%	Change	○
FE-64	Arithmetic unit 6 input 1 select	Default	0	Change	○
FE-65	Arithmetic unit 6 input 2 select	Default	0	Change	○
FE-66	Arithmetic unit 6 config	Default	0	Change	○
FE-67	Arithmetic unit 6 digital setting (corresponding to analog output 35)	Default	0.0%	Change	○
Setting range	All settings for arithmetic units 2~6 are identical to that for arithmetic unit 1, but the configuration scoping of arithmetic units 3~6 is from 0 to 8.				

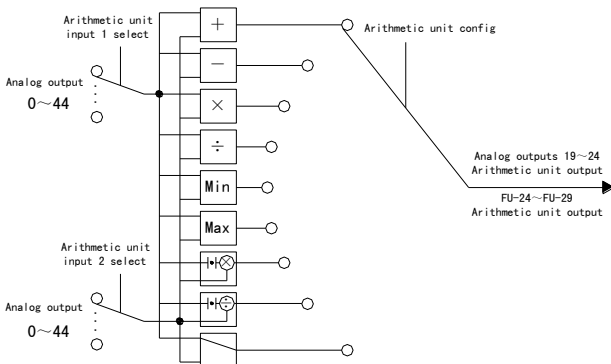
 The structure of the arithmetic unit is as the following diagram.



 Arithmetic unit 1 and 2 can map high and low values of FU-50 and 51 coder positions. Refer to page 108.

FE-68	Low-pass filter 1 input select	Default	0	Change	○
Setting range	Refer to the table of analog output functions in Section 6.7.				
FE-69	Low-pass filter 1 filtering time	Default	0.010s	Change	○
Setting range	0.000~10.000s				
FE-70	Low-pass filter 2 input select	Default	0	Change	○
Setting range	Refer to the table of analog output functions in Section 6.7.				
FE-71	Low-pass filter 2 filtering time	Default	0.010s	Change	○
Setting range	0.000~10.000s				

The structure of the low-pass filter is as the following diagram.

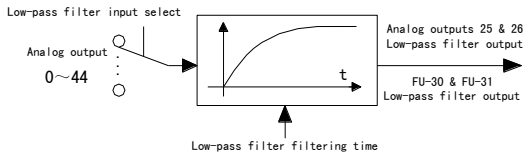

FE-72	Analog multi-switch input 1	Default	0	Change	○
Setting range	Refer to the table of analog output functions in Section 6.7.				
FE-73	Analog multi-switch input 2	Default	0	Change	○
Setting range	Refer to the table of analog output functions in Section 6.7.				
FE-74	Analog multi-switch control signal	Default	0	Change	○
Setting range	Refer to the table of digital output functions in Section 6.6.				

The structure of the analog multi-switch is as the following diagram.

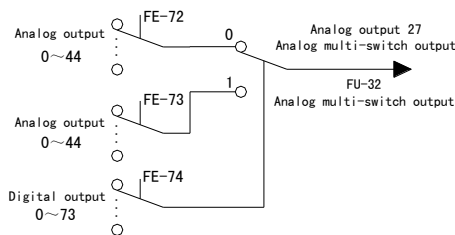

6.16 FF: Communication parameters

FF-00	Communication protocol	Default	0	Change	×
Setting range	0: Modbus protocol 1: Compatible USS commands 2: CAN bus				
FF-01	Data format	Default	0	Change	×

Setting range	0: 8,N,1 (1 start bit, 8 data bits, no parity check, 1 stop bit) 1: 8,E,1 (1start bit, 8 data bits, even check, 1 stop bit) 2: 8,O,1 (1 start bit, 8 data bits, odd check, 1 stop bit) 3: 8,N,2 (1 start bit, 8 data bits, no parity check, 2 stop bits)				
FF-02	Baud rate	Default	3	Change	×
Setting range	0: 1200bps 1: 2400bps 2: 4800bps 3: 9600bps 4: 19200bps 5: 38400bps 6: 57600bps 7: 115200bps 8: 250000bps 9: 500000bps Note: 0~5 for Modbus and USS, while 0~9 for CAN				
FF-03	Local address	Default	1	Change	×
Setting range	0~247 Note: 1~247 for Modbus, 0~31 for USS, and 0~127 for CAN				
FF-04	Overtime detection time	Default	10.0s	Change	○
Setting range	0.1~600.0s				
FF-05	Response delay	Default	5ms	Change	○
Setting range	0~1000ms				
FF-06	Overtime action	Default	0	Change	×
Setting range	0: No action 1: Alarm 2: Alarm and coast to a stop 3: Alarm and run according to F0-00 4: Alarm and run at upper-limit frequency 5: Alarm and run at lower-limit frequency				
FF-07	USS message PZD word number	Default	2	Change	×
Setting range	0~4				
FF-08	Communication reference magnification	Default	1.000	Change	○
Setting range	0.001~30.000. Frequency reference=FF-80×communication reference frequency				

☞ Hope800 inverter's RS485 Modbus protocol comprises three layers: Physical layer, Data Link layer and Application layer. The former two layers employ the RS485-based Modbus protocol. The application layer controls the run/stop of the inverter and the parameter reading and writing and so on.

☞ Modbus is a master-slave protocol. The communication between the master and slave falls into two types: master requests, slave responds; master broadcasts, slave doesn't respond. The master polls the slaves. Any slave can't send messages without receiving the command from the master. The master may resend the command when the communication is not correct. If the master doesn't get a response within given time, the slave polled is considered to be lost. The slave sends a piece of error information to the master if it can not implement a message.

☞ Communication only changes RAM values. If a parameter in RAM is to be written into EEPROM, the communication variable "EEP write command" (Modbus address is 3209H) needs to be changed to 1 by communication.

☞ Method of addressing the inverter parameters: among the 16 bits of the Modbus parameter address, the upper 8 bits represent the group number of a parameter, and the lower 8 bits represent the serial number of the same parameter in the group. For example, the address of the parameter F4-17 is 0511H. The group number is 50(32H) for communication variables (control word, status word, etc.).

Note: Communication variables include inverter parameters which can be accessed to by communication, as well as communication dedicated command variables and status variables. The menu codes correspond to the group numbers of parameters according to the following table.

Menu code	Parameter group No.	Menu code	Parameter group No.	Menu code	Parameter group No.	Menu code	Parameter group No.
F0	0(00H)	F5	5(05H)	FA	10(0AH)	FF	15(0FH)
F1	1(01H)	F6	6(06H)	Fb	11(0BH)	Fn	16(10H)
F2	2(02H)	F7	7(07H)	FC	12(0CH)	FP	17(11H)
F3	3(03H)	F8	8(08H)	Fd	13(0DH)	FU	18(12H)
F4	4(04H)	F9	9(09H)	FE	14(0EH)	Communication variables	50(32H)

 The data transmitted in communication are 16-bit integers. The minimum unit can be seen from the position of the radix point of the parameter. For example, the minimum unit of F0-00 is 0.01Hz, therefore, the data 5000 transmitted in communication represents 50.00Hz.

 Table of communication command variables

Name	Modbus address	Change	Description
Main control word	3200H	○	Bit 0: ON/OFF1(run on rising edge. 0: stop) Bit 1: OFF2(0: coast stop) Bit 2: OFF3(0: emergency stop) Bit 3: Driving lockout(0: driving lockout) Bit 4: Accel/decel enabled(0: accel/decel disabled) Bit 5: Reserved Bit 6: Reserved Bit 7: Fault reset(on rising edge) Bit 8: Jog forward Bit 9: Jog reverse Bit 10: Reserved Bit 11: Reference reversion(1: reference frequency reversed, 0: not reversed) Bit 12: PC digital 1(used for programmable unit) Bit 13: UP Bit 14: DOWN Bit 15: PC digital 2(used for programmable unit)
Communication reference frequency	3201H	○	Non-negatives (unit: 0.01Hz). Used as the frequency reference after multiplied by FF-08.
PC analog 1	3202H	○	Range: -32768~32767
PC analog 2	3203H	○	Except position control, set other situations within -10000~10000.
Extended control word 1	3204H	○	Bits 0~15 correspond to digital inputs 1~16
Extended control word 2	3205H	○	Bits 0~15 correspond to digital inputs 17~32
Extended control word 3	3206H	○	Bits 0~15 correspond to digital inputs 33~48
Extended control word 4	3207H	○	Bits 0~5 correspond to digital inputs 49~55, other bits are reserved.
Extended control word 5	3208H	○	Reserved
EEPROM write-in	3209H	○	When "1" is written to this address, the parameters in the inverter RAM will be written in EEPROM.

Note: Digital inputs 37, 38 and 39 are only used for terminal control. They are invalid in communication control.

 Table of communication status variables

Name	Modbus address	Change	Description
Main status word	3210H	Δ	Bit 0: Ready(constant 1) Bit 1: Ready for run Bit 8: Reserved Bit 2: Running Bit 9: Reserved Bit 3: Fault Bit 10: Frequency reach Bit 4: OFF2 valid(0: detection signal 1 valid) Bit 5: OFF3 stopping(0: Bit 11: Reserved valid) Bit 12: Reserved Bit 6: Charging contactor Bit 13: Reserved open Bit 14: Running forward Bit 7: Alarm Bit 15: Reserved
Operating frequency	3211H	△	Non-negatives(unit: 0.01Hz)
Arithmetic unit 1 output	3212H	△	Unit: 0.01% , Pulse number should be the unit when it is high and low word of coder position
Arithmetic unit 2 output	3213H	△	
Reference frequency	3214H	△	Non-negatives(unit: 0.01Hz)
Output current	3215H	△	Unit: 0.1A
Output torque	3216H	△	Rated torque with a unit of 0.1%
Output voltage	3217H	△	Unit: 0.1V
DC link voltage	3218H	△	Unit: 0.1V
Fault code	3219H	△	See page 123
Alarm word 1	321AH	△	See page 107
Alarm word 2	321BH	△	See page 107
Extended status word 1	321CH	△	Bits 0~15 correspond to digital outputs 0~15
Extended status word 2	321DH	△	Bits 0~15 correspond to digital outputs 16~31
Extended status word 3	321EH	△	Bits 0~15 correspond to digital outputs 32~47
Extended status word 4	321FH	△	Bits 0~15 correspond to digital outputs 48~63
Extended status word 5	3220H	△	Bits 0~9 correspond to digital outputs 64~73

 Hope800 inverter supports the communication on a Modbus network using RTU (Remote Terminal Unit) mode. The functions it supports include: Function 3(read multiple parameters, with max. word number of 50), Function 16(write multiple parameters, with max. word number of 10), Function 22(mask write) and Function 8(read-back test). Among them, Functions 16 and 22 support broadcast (broadcast message address is 0). In RTU mode, both the starting and ending of the message frame are marked by an interval of at least 3.5 character times(but 2ms for baud rates of 19200bit/s and 38400bit/s). A typical RTU message frame is shown below.

Slave address (1 byte)	Modbus function code (1 byte)	Data (multiple bytes)	CRC16 (2 bytes)
---------------------------	----------------------------------	--------------------------	--------------------

 Function 3: read multiple parameters. Word number read ranges from 1 to 50. Refer to the following example for its message format.

Example: read the main status word, operating frequency and arithmetic unit 1 output (three words with their addresses beginning with 3210H) from the #1 slave.

Query from master:

Slave address	01H
Modbus function code	03H
Start address(MSB)	32H
Start address(LSB)	10H
Word number read(MSB)	00H
Word number read(LSB)	03H
CRC(MSB)	0AH
CRC(LSB)	B6H

Response from slave:

Slave address	01H
Modbus function code	03H
Byte number returned	06H
MSB of 3210H	44H
LSB of 3210H	37H
MSB of 3211H	13H
LSB of 3211H	88H
MSB of 3212H	00H
LSB of 3212H	00H
CRC(LSB)	5FH
CRC(MSB)	5BH

☐ Function 6: single writing. Word is fixed at 1, and the query from master is consistent with response from slave. Refer to the following example for its message format.

Example: to make the #1 slave runs forward, you can rewrite the contents of address 3200H into 003FH:

Query from master:

Slave address	01H
Modbus function code	06H
Start address(MSB)	32H
Start address(LSB)	00H
Word number read(MSB)	00H
Word number read(LSB)	3FH
CRC(MSB)	C7H
CRC(LSB)	62H

Response from slave:

Slave address	01H
Modbus function code	06H
Start address(MSB)	32H
Start address(LSB)	00H
Word number read(MSB)	00H
Word number read(LSB)	3FH
CRC(MSB)	C7H
CRC(LSB)	62H

☐ Function 16: write multiple parameters. Word number written ranges from 1 to 10. Refer to the following example for its message format.

Example: to make the #1 slave runs forward at 50.00Hz, you can rewrite the two words with their addresses beginning with 3200H into 003FH and 1388H.

Query from master:

Slave address	01H
Modbus function code	10H
Start address(MSB)	32H
Start address(LSB)	00H
Word number written(MSB)	00H
Word number written(LSB)	02H
Byte number written	04H
MSB of 1st data	00H
LSB of 1st data	3FH
MSB of 2nd data	13H
LSB of 2nd data	88H
CRC(LSB)	83H
CRC(MSB)	94H

Response from slave:

Slave address	01H
Modbus function code	10H
Start address(MSB)	32H
Start address(LSB)	00H
Word number written(MSB)	00H
Word number written(LSB)	02H
CRC(LSB)	4FH
CRC(MSB)	70H

Example: to make the #1 slave stop(forward run at 50.00Hz), you can rewrite the two words with their addresses beginning with 3200H into 003EH and 1388H.

Query from master:

Response from slave:

Slave address	01H
Modbus function code	10H
Start address(MSB)	32H
Start address(LSB)	00H
Word number written(MSB)	00H
Word number written(LSB)	02H
Byte number written	04H
MSB of 1st data	00H
LSB of 1st data	3EH
MSB of 2nd data	13H
LSB of 2nd data	88H
CRC(LSB)	D2H
CRC(MSB)	54H

Slave address	01H
Modbus function code	10H
Start address(MSB)	32H
Start address(LSB)	00H
Word number written(MSB)	00H
Word number written(LSB)	02H
CRC(LSB)	4FH
CRC(MSB)	70H

Function 22: mask write

This function provides an easy way to modify certain bit(s) of the control word, compared to the complicated and time-consuming “read-change-write” method. It is only valid for the control word (including the main control word and extended control word). The operation is as follows:

Result= (operand & AndMask) | (OrMask & (~ AndMask)) , i.e.,

When all bits of OrMask are “0”: clear certain bit(s);

When all bits of OrMask are “1”: set certain bit(s) to “1”;

When all bits of AndMask are “0”: the result is OrMask;

When all bits of AndMask are “1”: the result remains unchanged

Example: set bit 7(digital input 24: process PID disabled) of the address 3205H(extended control word 2) of the #1 slave to 1 and then clear it. The query from the master and the response from the slave are as follows (the slave echoes the original function code)

Set bit 7 to 1

Slave address	01H
Modbus function code	16H
MSB of operand address	32H
LSB of operand address	05H
AndMask MSB	FFH
AndMask LSB	7FH
OrMask MSB	FFH
OrMask LSB	FFH
CRC(LSB)	3EH
CRC(MSB)	68H

Clear bit 7

Slave address	01H
Modbus function code	16H
MSB of operand address	32H
LSB of operand address	05H
AndMask MSB	FFH
AndMask LSB	7FH
OrMask MSB	00H
OrMask LSB	00H
CRC(LSB)	3FH
CRC(MSB)	D8H

Function 8: read-back test. The test code is 0000H. The original frame is required to return.

Exception response: if the slave fails to implement the request from the master, it will return an exception response message.

Example of read-back test:

Slave address	01H
Modbus function code	08H
MSB of test function code	00H
LSB of test function code	00H
MSB of test data	37H
LSB of test data	DAH
CRC(LSB)	77H
CRC(MSB)	A0H

Example of exception response:

Slave address	1 byte
Response code	1 byte(Modbus function code+80H)
Exception code	1 byte, with following meanings: 1: Modbus function codes that can't be handled 2: illegal data address 3: data value beyond the range 4: operation failed (such as attempting to write a read-only parameter, modify an unchangeable parameter during running, etc.)
CRC(LSB)	-
CRC(MSB)	-

Compatibility of USS commands

Hope800 inverter also supports USS commands. By using the host computer(including PC, PLC, etc.) software that supports the USS protocol, one can control the operation of the inverter, set its reference frequency and read its operation status parameters such as operating frequency, output current, output voltage and DC link voltage. Please contact us if you have such requirement.

6.17 FP: Fault history

FP-00	Last fault type	Min. unit	1	Change	Δ
Description	See the fault table below.				
FP-01	Cumulated run time at last fault	Min. unit	1h	Change	Δ
FP-02	Operating frequency at last fault	Min. unit	0.01Hz	Change	Δ
FP-03	Reference frequency at last fault	Min. unit	0.01Hz	Change	Δ
FP-04	Output current at last fault	Min. unit	0.1A	Change	Δ
FP-05	Output voltage at last fault	Min. unit	0.1V	Change	Δ
FP-06	Output capacity at last fault	Min. unit	0.1kW	Change	Δ
FP-07	DC link voltage at last fault	Min. unit	0.1V	Change	Δ
FP-08	Bridge temperature at last fault	Min. unit	0.1°C	Change	Δ
FP-09	Terminal input status 1 at last fault	Min. unit	1	Change	Δ
Description	Ten thousands digit: X5 Thousands digit: X4 Hundreds digit: X3 Tens digit: X2 Units digit: X1 (0: Invalid 1: Valid)				
FP-10	Terminal input status 2 at last fault	Min. unit	1	Change	Δ
Description	Hundreds digit: REV Tens digit: FWD Units digit: X6(0: Invalid 1: Valid)				
FP-11	2nd last fault type	Min. unit	1	Change	Δ
FP-12	Cumulated run time at 2nd last fault	Min. unit	1h	Change	Δ
FP-13	3rd last fault type	Min. unit	1	Change	Δ
FP-14	Cumulated run time at 3rd last fault	Min. unit	1h	Change	Δ
FP-15	4th last fault type	Min. unit	1	Change	Δ
FP-16	Cumulated run time at 4th last fault	Min. unit	1h	Change	Δ
FP-17	5th last fault type	Min. unit	1	Change	Δ
FP-18	Cumulated run time at 5th last fault	Min. unit	1h	Change	Δ
FP-19	Single-time run time at fault	Min. unit	0.1h	Change	Δ

FP-20	Fault history clear	Min. unit	1	Change	○
Setting range	11: Clear FP-00~FP-20.				
FP-21	Voltage of bus 2 during latest fault	Min. unit	0.1V	Change	△
FP-22	Temperature of inverter bridge 2 during latest fault	Min. unit	0.1℃	Change	△

 The following is the inverter fault table.

0: No fault







1. ocb: Momentary overcurrent at start	11. PLo: Output phase loss	22. CFE: Communication error
2. ocA: Overcurrent in accel	12. FoP: Power device protection	23. ccF: Current check error
3. ocd: Overcurrent in decel	13. oHI: Inverter overheating	24. ArF: Poor auto-tuning
4. ocn: Overcurrent in constant-speed run	14. oLI: Inverter overload	25. Aco: Analog input disconnection
5. ouA: Overvoltage in accel	15. oLL: Motor overload	26. PGo: PG disconnection
6. oud: Overvoltage in decel	16. EEF: External fault	27. rHo: Thermalsensitive resistor open
7. oun: Overvoltage in constant-speed run	17. oLP: Motor load overweight	28. Abb: Abnormal stop
8. ouE: Overvoltage in standby state	18. ULd: Inverter underload	29. Io1: Reserved
9. dcL: Undervoltage in run	19. Co1: Comparator 1 output protection signal	30. Io2: Reserved
10. PLI: Input phase loss	20. Co2: Comparator 2 output protection signal	31. PnL: Keypad disconnection
	21. EEP: Parameter saving failed	

 In the fault table, 32.oc1, 33.oc2, 34.co3, 35.GFF and 36.FoP only work for the model in parallel.

6.18 FU: Data monitoring

FU-00	Operating frequency	Min. unit	0.01Hz	Change	△
Description	Frequency of the motor speed				
FU-01	Reference frequency	Min. unit	0.01Hz	Change	△
Description	The unit indicator blinks				
FU-02	Output current	Min. unit	0.1A	Change	△
FU-03	Load current percentage	Min. unit	0.1%	Change	△
Description	Inverter rated current=100%				
FU-04	Output voltage	Min. unit	0.1V	Change	△
FU-05	Operating speed	Min. unit	1r/min	Change	△
Description	FU-05 = 120×operating frequency÷pole number×FC-13				
FU-06	Reference speed	Min. unit	1r/min	Change	△
Description	FU-06 = 120×reference frequency÷pole number×FC-13. The unit indicator blinks.				
FU-07	DC link voltage	Min. unit	0.1V	Change	△

FU-08	Output capacity	Min. unit	0.1kW	Change	Δ
FU-09	Output torque	Min. unit	0.1%	Change	Δ
FU-10	Reference torque	Min. unit	0.1%	Change	Δ
Description	The unit indicator blinks				
FU-11	Operating line speed	Min. unit	1m/s	Change	Δ
description	FU-11=operating frequency×FC-14				
FU-12	Reference line speed	Min. unit	1m/s	Change	Δ
Description	FU-12=reference frequency×FC-14. The unit indicator blinks.				
FU-13	PID feedback	Min. unit	0.1%	Change	Δ
Description	FU-13=PID feedback channel×F7-03				
FU-14	PID reference	Min. unit	0.1%	Change	Δ
Description	FU-14=PID reference channel×F7-03. The unit indicator blinks.				
FU-15	Counter count	Min. unit	1	Change	Δ
FU-16	Meter-counter actual length	Min. unit	1m	Change	Δ
FU-17	AI1	Min. unit	0.1%	Change	Δ
FU-18	AI2	Min. unit	0.1%	Change	Δ
FU-19	PFI	Min. unit	0.1%	Change	Δ
FU-20	UP/DOWN value	Min. unit	0.1%	Change	Δ
Description	The unit indicator blinks				
FU-21	PLC current mode and stage	Min. unit	1	Change	Δ
Description	Example: 2.03 indicates the 3rd stage of mode 2.				
FU-22	PLC cycled number	Min. unit	1	Change	Δ
FU-23	Remaining time of PLC current stage	Min. unit	0.1s/min	Change	Δ
FU-24	Arithmetic unit 1 output	Min. unit	0.1%	Change	Δ
FU-25	Arithmetic unit 2 output	Min. unit	0.1%	Change	Δ
FU-26	Arithmetic unit 3 output	Min. unit	0.1%	Change	Δ
FU-27	Arithmetic unit 4 output	Min. unit	0.1%	Change	Δ
FU-28	Arithmetic unit 5 output	Min. unit	0.1%	Change	Δ
FU-29	Arithmetic unit 6 output	Min. unit	0.1%	Change	Δ
FU-30	Low-pass filter 1 output	Min. unit	0.1%	Change	Δ
FU-31	Low-pass filter 2 output	Min. unit	0.1%	Change	Δ
FU-32	Analog multi-switch output	Min. unit	0.1%	Change	Δ
FU-33	PID output	Min. unit	0.1%	Change	Δ
FU-34	Counter error	Min. unit	0.01%	Change	Δ
Description	FU-34= (FU-15-F9-13)÷F9-14×100%				
FU-35	PG detection frequency	Min. unit	0.1Hz	Change	Δ
Description	It is a numerical value with signs and can represent forward or reverse run				
FU-36	Heat sink temperature	Min. unit	0.1°C	Change	Δ
FU-37	Output power factor	Min. unit	0.01	Change	Δ
FU-38	Watt-hour meter kWh	Min. unit	0.1kWh	Change	Δ

Description	0.0~6553.5kWh. Pressing  and  concurrently clears this parameter itself and the watt-hour meter timer.				
FU-39	Watt-hour meter timer	Min. unit	0.01h	Change	Δ
Setting range	0.00~655.35h. Pressing  and  concurrently clears this parameter itself and the watt-hour meter kWh.				
FU-40	Digital input terminal status 1	Min. unit	1	Change	Δ
Description	Ten thousands digit: X5 Thousands digit: X4 Hundreds digit: X3 Tens digit: X2 Units digit: X1 (0: Open 1: Closed)				
FU-41	Digital input terminal status 2	Min. unit	1	Change	Δ
Description	Hundreds digit: REV Tens digit: FWD Units digit: X6 (0: Open 1: Closed)				
FU-42	Digital output terminal status	Min. unit	1	Change	Δ
Description	Thousands digit: T2 Hundreds digit: T1 Tens digit: Y2 Units digit: Y1 (0: Open 1: Closed)				
FU-43	Expansion digital input terminal status	Min. unit	1	Change	Δ
Description	Ten thousands digit: X11 Thousands digit: X10 Hundreds digit: X9 Tens digit: X8 Units digit: X7 (0: Open 1: Closed)				
FU-44	Expansion digital output terminal status	Min. unit	1	Change	Δ
Description	Ten thousands digit: Y7 Thousands digit: Y6 Hundreds digit: Y5 Tens digit: Y4 Units digit: Y3 (0: Open 1: Closed)				
FU-45	Communication error times	Min. unit	1	Change	Δ
Description	0~60000				
FU-46	Reference frequency after accel/decel	Min. unit	0.01Hz	Change	Δ
Description	Frequency created after acceleration/deceleration				
FU-47	Output frequency	Min. unit	0.01Hz	Change	Δ
Description	Frequency output by the inverter (used by factory)				
FU-50	Coder position high word	Min. unit	1	Change	Δ
FU-51	Coder position low word	Min. unit	1	Change	Δ
Description	Actual position size can be reflected during position control. Based on 32 bit binary numbers, high word refers to high 16 bits and low word refers to low 16 bits.				
FU-52	Communication poll cycle	Min. unit	0.001s	Change	Δ
FU-53	Count value high word of counter 2	Min. unit	1	Change	Δ
FU-54	Count value low word of counter 2	Min. unit	1	Change	Δ
Description	Deviation of rated position and actual position can be reflected during position control. Based on 32 bit binary numbers, high word refers to high 16 bits and low word refers to low 16 bits.				
FU-55	Max. current holding	Min. unit	0.1A	Change	Δ
Description	It is cleared by pressing  and  concurrently.				
FU-60	Total run time of air blower	Min. unit	1h	Change	Δ
Others	Reserved	Min. unit	-	Change	-

7 Troubleshooting

7.1 Faults and remedies

Fault code	Fault type	Possible causes	Remedies
<i>Er.ocb</i> Er.ocb(1)	Overcurrent at start	Inter-phase or grounding short-circuit inside the motor or between wirings	Check the motor and wiring
		Inverting module failed	Call us
		Voltage overhigh at start	Check the setting of “torque boost”
<i>Er.ocA</i> Er.ocA(2)	Overcurrent during acceleration	Accel time too short	Increase the accel time
		V/F curve improper	Regulate V/F curve or the setting of “torque boost”
		Running motor restarts	Set the start mode as “smooth start” Restart the motor after it stops completely
		Low power grid voltage	Check the input power
		Inverter capacity too small	Use an inverter with larger capacity
		Auto-tuning not performed for vector control	Perform the parameter auto-tuning
<i>Er.ocd</i> Er.ocd(3)	Overcurrent during deceleration	Decel time too short	Increase the decel time
		There is potential energy load or inertial torque of the load is large	Install an external dynamic braking unit
		Inverter capacity too small	Use an inverter with larger capacity
		Auto-tuning not performed for vector control	Perform the parameter auto-tuning
<i>Er.ocn</i> Er.ocn(4)	Overcurrent during constant-speed operation	Sudden change of load	Reduce the sudden change of the load
		load error	Check the load
		Low power grid voltage	Check the input power
		Inverter capacity too small	Use an inverter with larger capacity
		Auto-tuning not performed for vector control	Perform the parameter auto-tuning
<i>Er.ouA</i> Er.ouA(5)	Overvoltage during acceleration	Input voltage abnormal	Check the input power
		Running motor restarts	Set the start mode as “smooth start” Restart the motor after it stops completely
<i>Er.oud</i> Er.oud(6)	Overvoltage during deceleration	Decel time too short	Increase the decel time
		There is potential energy load or inertial torque of the load is large	Employ a dynamic braking unit
		Input voltage abnormal	Check the input power
		Improper ASR setting	Adjust ASR parameter reducing overshoot

Fault code	Fault type	Possible causes	Remedies
<i>Er.oun</i> Er.oun(7)	Overvoltage during constant-speed operation	Input voltage abnormal	Check the input power
		Accel/decel time too short	Increase the accel/decel time
		Input voltage changes irregularly	Install an input reactor
		Large load inertia	Employ a dynamic braking unit
<i>Er.ouE</i> Er.ouE(8)	Overvoltage in standby state	Input voltage overhigh	Check the input power
		Error of DC bus voltage test circuit	Call us





Fault code	Fault type	Possible causes	Remedies
<i>Er.dcl</i> Er.dcl(9)	Undervoltage during running	Input voltage abnormal or power loss during running	Check input power and wiring
		There is heavy-load impact	Check the load
		Charging contactor failed	Check and replace it
		Input phase loss	Input the input power and wiring
<i>Er.PLI</i> Er.PLI(10)	Input phase loss	R, S or T phase loss	Check the wiring
		Three input phases imbalanced	Check input voltage
		Serious oscillation of output	Adjust parameters to eliminate the oscillation
<i>Er.PLo</i> Er.PLo(11)	Output phase loss	Loss of output (U, V or W)	Check the output wiring Check the motor and cables
<i>Er.FoP</i> Er.FoP(12)	Power device protection	Output has interphase short-circuit or grounding short-circuit	Rewire
		Wiring of or components on the control board loose	Check and rewire
		Wiring of the motor or inverter too long	Add output reactor or filter
		Overcurrent of braking unit of 15kW inverter or below	Check the external braking resistance and wiring
		Serious interference or failure of inverter	Call us
<i>Er.oHI</i> Er.oHI(13)	Inverter overheating	Ambient temperature overhigh	Lower the ambient temperature
		Air path blocked or the fan failed	Clean air path or replace the fan
		Load too heavy	Check the load or select an high-capacity inverter
<i>Er.oLI</i> Er.oLI(14)	Inverter overload	Load too heavy	Check the load or select an high-capacity inverter
		Inverter temperature too high	Check the fan, air path and ambient temperature
		Accel time too short	Increase the accel time
		Carrier frequency too high	Lower the carrier frequency or select an inverter with a higher capacity
		V/F curve improper	Regulate V/F curve and torque boost level

Fault code	Fault type	Possible causes	Remedies
		Running motor restarted	Set the restart mode as “smooth restart” or “restart after motor stops”
		Input voltage too low	Check the input voltage
<i>Er.oLL</i> Er.oLL(15)	Motor overload	V/F curve improper	Correctly set the V/F curve and torque boost level
		The common motor runs with heavy load at low speed for a long time	Install a separate cooling fan or select a motor designed for inverter
		Improper setting of nameplate parameters or overload protection	Set FA-03, Fb-00 and Fb-01 correctly
		Motor stalls or load changes suddenly and greatly	Check the load
<i>Er.EEF</i> Er.EEF(16)	External fault	External fault terminal closed	Deal with the external fault
<i>Er.oLP</i> Er.oLP(17)	Motor load overweight	Motor current exceeds the load overweight detection level, and the detection time is exceeded	Check the load Check the setting of load overweight protection
<i>Er.ULd</i> Er.ULd(18)	Inverter underload	Inverter output current is less than the underload protection level, and the detection time is exceeded	Check the load Check the setting of underload protection
<i>Er.Co1</i> Er.Co1(19)	Comparator 1 output protection signal	Generated by comparator 1	Check the definition of comparator 1 output
<i>Er.Co2</i> Er.Co2(20)	Comparator 2 output protection signal	Generated by comparator 2	Check the definition of comparator 2 output
<i>Er.EEP</i> Er.EEP(21)	Parameter saving failed	Failure in writing parameters	Retry after reset. Call us if problem still exists.
<i>Er.CFE</i> Er.CFE(22)	Communication error	Improper setting of communication parameters	Check the settings of FF menu
		Serious communication interference	Check the wiring and grounding of the communication circuit
		PC does not work	Check PC and wiring
<i>Er.ccf</i> Er.ccf(23)	Current test error	Loose wiring or components inside the inverter	Check and rewire
		failed current sensor or circuit error	Call us
<i>Er.ArF</i> Er.ArF(24)	Poor auto-tuning	Incorrect setting of motor nameplate parameters	Set the parameters according to the motor nameplate
		Motor not connected or motor phase lost	Check the motor wiring
		Motor not in no-load state during rotary auto-tuning	Disconnect the motor from the mechanical load
		Oscillation of auto-tuning	Adjust F2-09

Fault code	Fault type	Possible causes	Remedies
<i>Er.Aco</i> Er.Aco(25)	Analog input disconnection	Wires broken or peripheral devices failed	Check external wires and peripheral devices
		Disconnection threshold not set properly	Check the settings of F6-06 and F6-13
<i>Er.PGo</i> Er.PGo(26)	PG disconnected	Error of connecting wires for encoder interface board	Check the wires
<i>Er.rHo</i> Er.rHo(27)	Thermal resistor open	Encoder interface board jumper not set properly	Check the jumper(refer to paragraph 9.6)
		Fd-05 too short	Increase it moderately
		Encoder failed	Check and replace it
		Thermal resistor disconnected	Check the connection of thermal resistor or call us
<i>Er.PLI</i> Er.PLI(10)	Input phase loss	R, S or T phase loss	Check the wiring
<i>Er.Abb</i> Er.Abb(28)	Abnormal stop	Stall state lasts one minute	Set the operating parameters correctly
		Try to use <input type="checkbox"/> to stop the inverter while keypad is disabled	-
		Overspeed due to reverse connection of PG	Check the connection of PG
<i>Er.Io1</i> Er.Io1(29)	Reserved	-	-
<i>Er.Io2</i> Er.Io2(30)	Reserved	-	-
<i>Er.PnL</i> Er.PnL(31)	Keypad disconnection	Keypad lost or disconnected	-
<i>Er.cno</i> Er.cno(37)	Abnormal charging contactor (only works for hardware test)	Grid voltage is too low	Check the power grid
		Contactor damaged	Replace contactor or call us
		Electricity buffer resistance damaged	Replace buffer resistance or call us
		Control loop damaged	Call us



7.2 Alarms and remedies

Alarm code	Alarm name	Description	Remedies	Alarm word Bit
<i>AL.oLL</i> AL.oLL	Motor overload	Motor thermal model detects the motor temperature rise is overhigh	Refer to above table	Word 1 Bit 0
<i>AL.oLP</i> AL.oLP	Motor load overweight	Motor current exceeds the load overweight detection level, and the detection time is exceeded	Refer to above table	Word 1 Bit 1

<i>ALULd</i> AL.ULd	Inverter underload	Inverter output current is less than the underload protection level, and the detection time is exceeded	Refer to above table	Word 1 Bit 2
<i>ALPnL</i> AL.PnL	Keypad disconnection	Keypad lost or disconnected (alarm signal is output via the terminal)	Refer to above table	Word 1 Bit 4
<i>ALARco</i> AL.Aco	Analog input drop	Analog input signal is lower than the drop threshold	Refer to above table	Word 1 Bit 5
<i>ALPLI</i> AL.PLI	Input phase loss	Lack of input phase or imbalance among three phases	Refer to above table	Word 1 Bit 6
<i>ALPLo</i> AL.PLo	Output phase loss	Lack of output phase	Refer to above table	Word 1 Bit 7
<i>ALCFE</i> AL.CFE	Communication error	Communication timeout	Refer to above table	Word 1 Bit 8
<i>ALEEP</i> AL.EEP	Parameter saving failed	Failure in writing parameters	Refer to above table Press  to clear	Word 1 Bit 9
<i>ALdcL</i> AL.dcL	DC link undervoltage	DC link voltage is lower than the threshold	It is normal for this alarm information to be displayed when the power is off	Word 1 Bit 11
<i>ALCo1</i> AL.Co1	Comparator 1 output protection	Generated by comparator 1	Check the definition of comparator 1 output	Word 1 Bit 12
<i>ALCo2</i> AL.Co2	Comparator 2 output protection	Generated by comparator 2	Check the definition of comparator 2 output	Word 1 Bit 13
<i>ALPGo</i> AL.PGo	PG disconnected	No PG signal	Refer to above table	Word 1 Bit 14
<i>ALPcE</i> AL.PcE	Parameter check error	Improper parameter setting	Correct parameter setting or restore factory setting. Press  to clear	Word 2 Bit 1
Alarm code	Alarm name	Description	Remedies	Alarm word Bit
<i>ALUPF</i> AL.Pdd	Keypad data inconsistent	Parameters stored in keypad differs from those in the inverter	Press  to clear	Word 2 Bit 2
<i>ALUPF</i> AL.UPF	Parameter upload failed	Keypad EEP error during parameter uploading	Check to see: 1. If the keypad is of SB-PU70E type; 2. If the connecting wire is too long; 3. If the interference is too great. And retry. Press  to clear	Word 2 Bit 3

<i>ALPdE</i> AL.PdE	Keypad data error	Keypad data check error during parameter downloading and comparing		Word 2 Bit 4
------------------------	-------------------	--	--	-----------------

7.3 Operation faults and remedies

Fault	Description	Possible causes	Remedies
No key-press response	One key or all keys have no response to key pressing	The key(s) is(are) automatically locked	Unlock it(them) by pressing  +  for three seconds
		Poor contact of the keypad connecting wire	Check the connecting wire or call us
		Key(s) damaged	Replace the keypad
		Chip damaged	Call us
Parameter correction failed	Parameters cannot be modified	F0-10 is set to 1 or 2	Set F0-10 to 0
		The parameters are read-only ones	Read-only parameters are unchangeable
	Parameters cannot be modified in running state	Some parameters are unchangeable during running	Modify them in standby state
Unexpected stop during running	Inverter stops automatically without receiving stop command, and the run LED is off	There is fault	Troubleshoot and reset it
		PLC cycle completed	Check the PLC parameter setting
		Run command channel switches over	Check the operation and run command channel status
		Fb-18=3 and the power cut time is too long	Check the DC link undervoltage setting and input voltage
	Inverter stops automatically without receiving stop command, and the run LED is on	Waiting for the fault auto reset	Check auto reset setting
		In PLC pause state	Check PLC parameter setting
		Run interruption	Check run interruption setting
		Reference frequency is zero	Check reference frequency
Inverter start failed	After receiving start command, inverter fails to start, and the run LED is off	Digital input 18 is valid	Check terminal “coast stop”
		Digital input 17 is valid	Check terminal “inverter run disabled”
		The stop key is not closed under 3-wire 1, 2 or 2-wire 3 control mode	Check the stop key and its connection
		Run command channel error	Change the run command channel
		Inverter error	Troubleshoot
		Input terminal logic error	Check the setting of F4-09 and F4-10

		Voltage of the bus of model in parallel is inconsistent	Check power input loop, voltage inspection loop, etc.
--	--	---	---

8 Maintenance and After-sale Service

Danger

- 1. Only professionally trained persons can disassemble and repair the inverter and replace its parts.**
- 2. Make sure the power supply of the inverter is cut off, the high-voltage indicator goes out and the voltage between DC+ and DC- is less than 36V before checking and repairing the inverter, otherwise there may be a risk of electric shock.**
- 3. Do not leave any metal pieces such as screws and washers in the inverter. That may destroy the inverter or cause fire.**
- 4. Reset related parameters after replacing the control board, otherwise the inverter may be destroyed.**

8.1 Daily maintenance

Due to factors of dust, humidity, vibration, aging, etc., faults would occur over time. It is necessary to check the inverter and its working environment regularly in order to extend the lifespan of the inverter.

Check points:

1. If the working environment of the inverter meets the requirement.
2. If the operating parameters of the inverter are set within the specified ranges.
3. If there is any unusual vibration or noise.
4. If there is any unusual odor.
5. If the fans run normally.
6. If the input voltage is within the specified range and voltages of various phases are balanced.

8.2 Periodical maintenance

The periodical maintenance should be performed once every three or six months according to the service conditions. Check points:

1. If the screws of control terminals are loose.
2. If the main circuit terminals have a poor contact and the copperplate connections have traces of overheating.
3. If the power and control cables are damaged.
4. If the insulated binding band for the cold-pressed terminals of the power cables comes off.
5. Remove dust on PCBs and wind path thoroughly. It's better to use a vacuum cleaner.
6. When leaving the inverter unused for a long term, check it for functioning once every two years by supplying it with electricity for at least five hours with the motor disconnected. While supplying the power, use a voltage regulator to raise the voltage gradually to the rated value.

Danger: Motor insulation test must be performed with the inverter disconnected, otherwise the inverter may be destroyed.

Danger: Do not perform the voltage resistance test or insulation test on the control circuit. That may destroy the circuit components on it.

8.3 Replacement of parts

◆ Cooling fan

Causes of damage: wear of bearings; aging of blades(average life is 30 to 40 thousand hours).

Judging criterion: crack in blades, etc.; unusual vibration at the start.

Caution:

1. While replacing the fan, use the fan model designated by the factory(with identical rated voltage, current, speed and air volume).
2. While installing the fan, be careful that the direction marked on the fan must conform to direction in which the fan supplies wind.
3. Do not forget to install the fan guard.

◆ Electrolytic capacitor

Causes of damage: high ambient temperature; frequent and sudden load change which leads to high pulsating current; aging of electrolyte.

Judging criterion: protrusion of safety valve; measurement of static capacitance; measurement of insulation resistance.

It is recommended to replace the bus electrolytic capacitor once every four or five years.

8.4 Storage of the inverter

- ◆ Avoid storing the inverter in a place with high-temperature, humidity, dust and metal powder.
- ◆ Leaving the inverter unused for a long period would lead to aging of the electrolytic capacitors. So the inverter must be supplied with electricity once every two years for at least five hours, and the input voltage raised gradually through a regulator to the rated value.

8.5 After-sale services

The warranty period is one year from the purchase date. However, the repair cost should be borne by the user for the following damages even within this term.

1. Damage caused by operation not in accordance with the user's manual.
2. Damage caused by unauthorized repairs or modifications.
3. Damage caused by using the inverter beyond the standard specifications.
4. Damage caused by falling or an accident during transportation after the purchase.
5. Damage cause by fire, flood, abnormal voltage, lightning strike, etc.

When the inverter works abnormally, it shall be inspected and adjusted according to manual. If there is fault, please contact the Supplier or local electric company of Slanvert or headquarters of company. Within guarantee period, our company will repair the fault caused by manufacture and design for free; however, our company will repair the faults caused beyond guarantee period with payment according to customer's requirements.

9 Options

We offer the following options which you can purchase from us as you require.

9.1 Braking unit

It is all right to configure an appropriate braking resistor for an inverter with a built-in braking unit. But for an inverter without a built-in braking unit, the SZ series braking unit and braking resistor are needed. The resistance of the braking resistor should not be less than the recommended value, or the inverter may be damaged. The capacity of the braking resistor must be decided based on the power generation condition (power generation capacity, frequency of power generation, etc.) of the actual load.

SZ20G series braking units and braking resistor are coordinated to absorb regenerative power energy generated by motor during braking and avoid inverter overvoltage. Except employing on Slanvert inverter, it is also can be employed on other inverters. Meanwhile, there are four kinds of braking voltage available, which is also applicable to parallel connection of multiple equipment to obtain larger braking power. Wiring diagram of Slanvert SZ series braking unit is as follows:

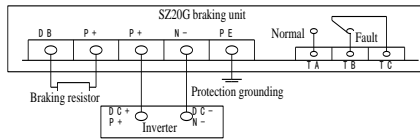

Wire between braking unit and inverter and braking resistor shall be within 5m, with minimum surrounded loop area.

The SZ series braking units are as follow:

Braking unit model	Resistance(Ω)	Allowable Inverter(KW)	Braking Voltage (V)
SZ20G-30	≥22	18.5/22	680
SZ20G-60	≥11	30/37	680
SZ20G-85	≥8	45/55	680
SZ20G-130	≥5	75/90	680
SZ20G-170	≥4	110	680
SZ20G-260	≥2.6	132/160	680
SZ20G-380	≥1.8	200/250	680

Note: if resistance value exceeds the recommended data in table above, the braking capacity is weakened. In general, it shall not be 1.5~2.0 times higher than recommended resistance value.

Caution: braking resistor belongs to heating device, thus cabinet shall be independently installed during application, otherwise, there will be risks of causing fire.

9.2 Communication component

- Keypad extension line

Length of the extension line can be determined by the user.

- Background monitoring software SbMonitor

It is applicable to an RS485-based network composed of SenLan inverters. It can realize the real-time monitoring of the inverters and the centralllized management.

- Profibus-DP PBTOMM module

9.3 AC reactor

Hope800 series model P1 and DC+ with power of 90kw or above is not equipped with short circuit copper piece and DC reactor shall be used between them. The AC reactor on the input side can suppress the higher harmonics of the input current and improve the input-side power factor. We suggest you use it in following cases:

- The power grid capacity is far greater than that of the inverter and the inverter's power is larger than 30kW.
- A load of thyristor or power factor compensator (with switch control) shares the same power supply with the inverter.
- The voltage imbalance of the 3-phase power is greater than 3%.
- The input-side power factor needs improving.

The reactor can:

- Reduce the inverter output harmonics.
- Prevent the motor insulation being damaged.
- Lower the output-side common-mode interference and the motor shaft current.

9.4 EMI filter and ferrite chip common-mode filter

The EMI filter is used to suppress the inverter-generated radio interference, external radio interference as well as the interference of transient shock and surge with the inverter, and the ferrite chip common-mode filter (magnetic ring) is employed to restrain the inverter-generated radio interference.

Filters should be used in applications where there is a high anti-radio disturbance requirement, CE/UL/CSA standards must be met, or devices with poor interference immunity are around the inverter. While installing them, try to minimize the wiring and locate them as close as possible to the inverter.

9.5 Digital I/O expansion board

The digital I/O expansion board is used to expand the digital input and output terminals.

Installation method: (1) confirm the power of the inverter is turned off.; (2) insert the plastic poles shipped with the expansion board into the holes on the main control board; (3) align the connector on the expansion board with the connector on the main control board(J1) and align the two mounting holes on the expansion board with the plastic poles, and then press down.

Basic wiring diagram:

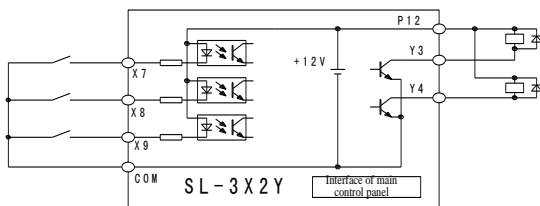

The digital I/O expansion board provides multi-channel inputs and outputs. The number of the channels can be decided by the user, for example, 5 channels of digital input (SL-5X), 5 channels of digital output (SL-5Y) and 3 channels of digital input plus 2 channels of digital output(SL-3X2Y).

The functions and specifications of the terminals are as follows (take SL-3X2Y as an example):

Symbol	Terminal	Function	Specification
X7	X7 expansion digital input	Multiple functions, refer to Section 6.14. Monitored parameter: FU-43	Optocoupler isolation Input impedance: $\geq 3.9k\Omega$ Sampling period: 2ms Input voltage: $< 25V$ Hige level: $> 10V$ Low level: $< 3V$
X8	X8 expansion digital input		
X9	X9 expansion digital input		
P12	12V power	12V power offered to the user	Max. output current for 12V power: 80mA
COM		12V power ground	
Y3	Y3 expansion digital output	Multiple functions, refer to Section 6.14. Monitored parameter: FU-44	Optocoupler isolation Open collector output Output action frequency: $< 250Hz$ Start-up voltage: $< 1.0V$ 24V DC/50mA
Y4	Y4 expansion digital output		

9.6 Encoder interface board(SL-PG0)

The encoder interface board is used to receive signals from the encoder, so that the inverter can implement PG V/F control or PG vector control. It is also used in the high-speed counting of numbers or meters. Moreover, it can be connected to the reference frequency via the analog input 16.

Installation method: (1) confirm the power of the inverter is disconnected; (2) insert the plastic poles shipped with the interface board into the holes on the main control board; (3) align the connector on the interface board with the connector on the main control board(J1) and align the two mounting holes on the expansion board with the plastic poles, and then press down.

The encoder interface board is nearly compatible with all encoders with different types of output: open collector type (NPN and PNP), voltage type, complementary push-pull type and differential output type. It offers isolated power supplies of 12V and 5V.

Caution: the input type of the encoder and the power supply must be selected by the jumper. The default jumper setting is 12V and NPN encoder.

Basic wiring diagram (for 12V, differential output type encoder):

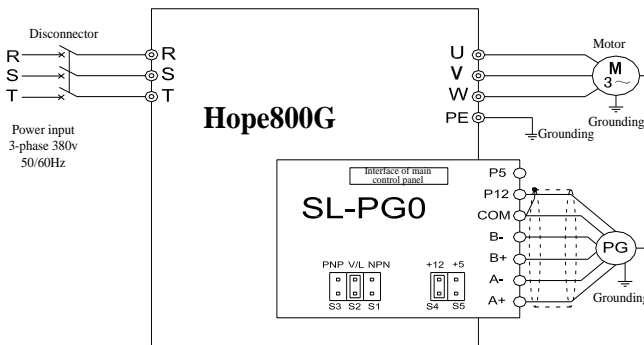



The functions and specifications of the terminals on the encoder interface board are as follows.

9 选配件

Symbol	Terminal	Function	Specification
A+	Encoder terminal A+ input	A+ signal input	Max. input frequency: 300kHz Only channel A is connected for single-channel encoder. Non differential input type must be connected from A+ or B+, while A- and B- are left floating.
A-	Encoder terminal A- input	A- signal input	
B+	Encoder terminal B+ input	B+ signal input	
B-	Encoder terminal B- input	B- signal input	
COM	Power ground	Ground of P12 and P5 power supplies and signals Isolated from GND of main control board	-
P12	12V power terminal	12V power offered to user	Max. output current: 80mA
P5	5V power terminal	5V power offered to user	Max. output current: 200mA

Power jumpers of the encoder interface board:

Power supply	12V	5V
Jumper position	+12 +5  S4 S5	+12 +5  S4 S5

Jumpers for encoder output type:

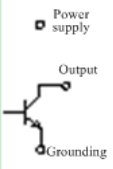
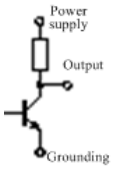
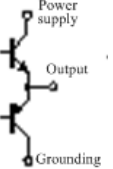
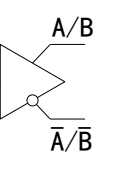
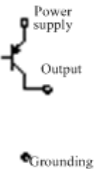
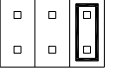
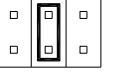
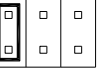
Type	NPN type	Voltage type	Complementary push-pull type	Differential output type	PNP type
Output structure					
Jumper position	PNP V/L NPN  S3 S2 S1		PNP V/L NPN  S3 S2 S1		PNP V/L NPN  S3 S2 S1

<p>Attention</p>	<ol style="list-style-type: none"> 1. The coaxial degree of the mechanical shaft and encoder should meet the requirement, or torque fluctuation and mechanical vibration would occur. 2. It is recommended to use shielded twisted pair to connect the encoder and the encoder interface board. The shielded layer of the twisted pair (near the inverter) must be connected to COM on the encoder interface board. 3. The encoder signal lines must be separated from the power lines, otherwise the electromagnetic interference would affect the output signals of the encoder. 4. Grounding the encoder case can reduce interference.
------------------	---

9.7 Keypad options

SB-PU70E has the function of parameter copying, which is quite useful to set the same parameters on multiple inverters.

SB-PU03 is a keypad with a potentiometer, which facilitates the adjustment of the setting.

SB-PU05 is provided with encoder keypad, which is applicable to the situation that machine tool requires high precision potentiometer.

SB-PU04 LCD has Chinese/English display and parameter copying functions with software version above V0.90:

SB-PU04 LCD keypad is applicable to Slanvert Hope800 series inverter, with functions including, parameter setting, check, operation control, fault display, alarm information, help information and parameter copying. The keypad is shown below:

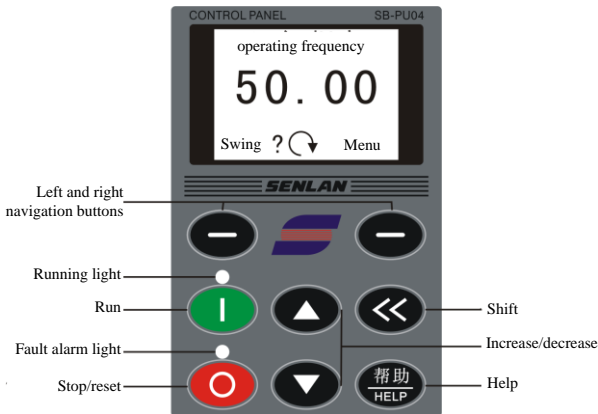

Basic hierarchical structure of LCD keypad is as follows:

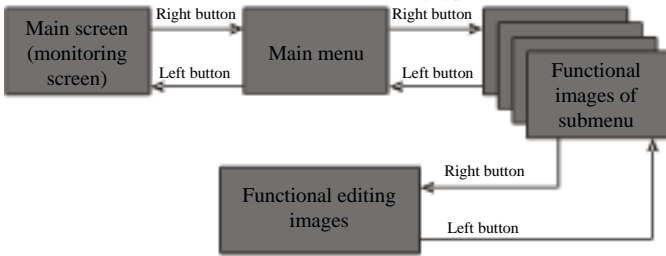

Table of menu structure function:

Main menu	Submenu	Functions
Parameter setting	Functional group No.	Set Inverter parameter
PID regulator	-	Set PID parameter setting
I/O interface setting	Digital input	Enter relevant parameters
	Digital output	
	Analog input	
	Analog output	
I/O interface state	State of terminal X	Display relevant state
	State of terminal Y	
	Relay terminal	
	Analog input terminal	
Parameters backup	Uploaded to the panel	Execute relevant operations
	Downloaded the inverter	
	Parameters different from panel	
	Clear backup data	
Modified parameters	-	Display the parameters that is different from default
User parameters	User parameter list	Modify relevant functions
	Change user parameters	Define user parameter function No.
LCD setting	LCD contrast adjustment	Modify display contrast
	Time setting	Time setting
	Monitoring menu font	Modify display mode of main screen
	Switching time of monitoring items	Modify switching time of monitoring items on main screen
	^ v button reference selection	Define the functions of ^ v button on main screen
	LCD software version Vx.xx	Current software version
	LCD monitoring content selection	Modify the monitoring contents of 6 monitoring items on main screen
	Language selection	Language selection (Chinese/English)

Keyboard lock: (FC-01 is required to be modified) press help button and then press right button to return to monitoring screen after it is succeeded.

Keyboard unlock: press help button and shift button at the same time (more than 3s).

9.8 keypad mounting box

It is used to install the keypad on the cabinet. Refer to section 3.2.2 for the mounting size.

9.9 Analog input expansion board

Call us if you need it.