

Voith Turbo

**VOITH**

## Voith Multiple-Flow Pumps – Programme



# Contents

<b>Voith internal gear pumps setting standards</b>	3
Applications	4
<hr/>	
<b>1. Single pumps</b>	5
1.1 Procedure for selection of single pumps	5
1.2 Oder description and model code	6–7
Type IPH	6
Type IPV	6
Type IPC	7
Type IPN	7
<hr/>	
<b>2. Multiple-flow pumps</b>	8
2.1 Procedure for deterring multiple-flow pumps	8
2.2 Determining pump sequence for multiple-flow pump combinations	9–10
2.3 Order description of multiple-flow pumps	11
2.4 Possible pump combinations of two or more pumps	12–13
2.5 Torque control	14–15
2.6 Determining the intermediate housing	16–17
2.7 Dimensions of the intermediate housing for multiple-flow pumps	18–19
2.7.1 SAE mounting flange	20
2.8 SAE suction and pressure flanges	21
2.9 Dimension chains for pump combinations, calculation of total length	22
2.9.1 Length of Voith IP pumps	23
<hr/>	
<b>3. Combining Voith IP pumps with pumps from other manufacturers</b>	24
3.1 Mounting pumps from other manufacturers on to Voith IP pumps	24
3.1.1 Intermediate housing with coupling	25
3.2 Mounting Voith IP pumps on to pumps from other manufacturers	26
3.2.1 Order description for Voith IP pumps on to pumps from other manufacturers	27
<hr/>	
<b>Order details</b>	29

# Voith internal gear pumps setting standards

The market requires hydraulic pumps to be compact and requires a further reduction of noise level and pressure pulsation at high efficiency.

Voith internal gear pumps have a large range of applications where low operation noise, high efficiency, compact dimensions and light weight are required.

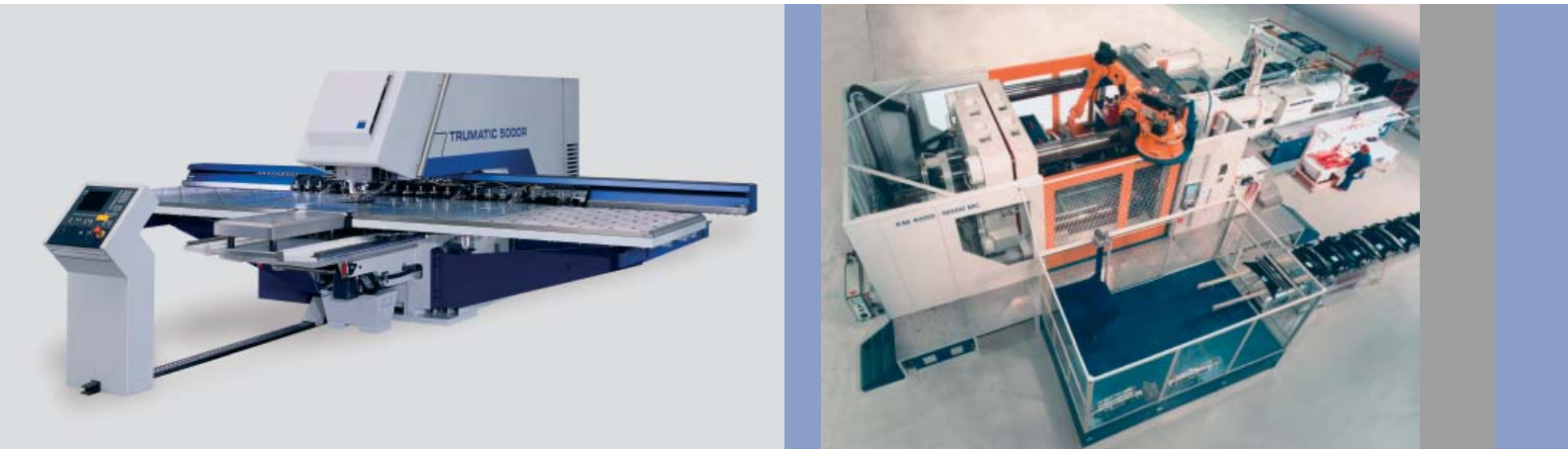

## Applications:

- **Plastics engineering**  
Plastics injections moulding and blow moulding machines
- **Metal working machines**  
Press brakes, shears, punching machines
- **General press manufacturing**
- **Materials handling**  
Crane construction, lifting platforms, electric fork lifts
- **Shipbuilding**  
Steering gear, stabilizers, deck cranes
- **Public service vehicles**  
Refuse-collecting vehicles, special vehicles
- **Power generation**  
Hydrostatic support and lifting of gas, steam, and water turbine runners and generators

# Applications



*Fine blanking press*



*Press*



*Wide load crane*



*Excavator*



*Hydraulic press brake*



*Lifting platform*



*Machine tool*



*Marine applications*

# 1. Single pumps

## 1.1 Procedure for selection of single pumps

**In order to be able to select an internal gear pump the following parameter are required:**

- continuous pressure in the system
- maximum pressure in the system
- capacity per revolution or absolute flow-rate at the given speed.

**The following data sheets are available:**

Data sheets for IPH 4 to IPH 6	Leaflet G 1209 Internal gear pump type IPH
Data sheets for IPC 4 to IPC 7	Leaflet G 1209 Internal gear pump type IPC
Data sheets for IPV 3 to IPV 7	Leaflet G 1485 High pressure internal gear pump type IPV
Data sheets for IPN 4 to IPN 6	Leaflet G 1418 Low pressure internal gear pump type IPN with the Voith Superlip System

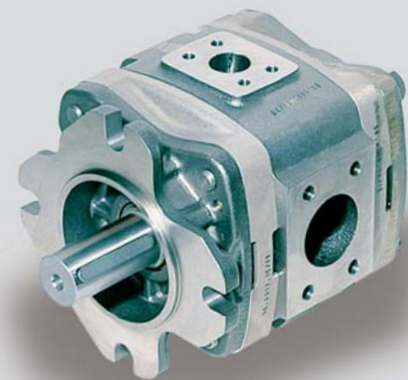

The model code for the single pumps can be found on the following pages.

It is made up of the pump model, size, capacity and a 3 digit design number.

# 1.2 Order description and model code

## Type IPH

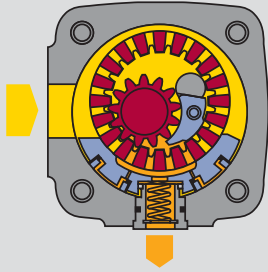

**IPH 4 - 20 1 0 1** Example of order description

**Shaft end**

- 0 Toothed shaft ANSI B92.1a
- 1 Feather key

**Fastening flange**

- 0 SAE 2-hole
- 1 SAE 4-hole

**Direction of rotation and suction**

- 1 Clockwise rotation, radial suction mounting
- 6 Anti-clockwise rotation, radial suction mounting
- 4 Special design pumps, clockwise rotation
- 9 Special design pumps, anti-clockwise rotation

**Capacity [cm<sup>3</sup>/rev.]**

<b>20</b>	40	80
25	50	100
32	64	125

**Size**

- 4 5 6

**Internal gear pump type**  
**IPH**

## Type IPV

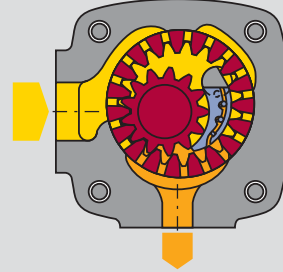

**IPV 3 - 3,5 1 0 0** Example of order description

**Shaft end**

- 0 Toothed shaft ANSI B92.1a
- 1 Feather key

**Fastening flange**

- 0 SAE 2-hole
- 1 SAE 4-hole
- 4 VDMA 2-hole, DIN/ISO 3019/2
- 5 VDMA 4-hole, DIN/ISO 3019/2
- 7 SAE 2-hole (except for IPV 4 with differing centering diameter)

**Direction of rotation and suction**

- 1 Clockwise rotation, radial suction mounting
- 6 Anti-clockwise rotation, radial suction mounting
- 4 Special design pumps, clockwise rotation
- 9 Special design pumps, anti-clockwise rotation

**Capacity [cm<sup>3</sup>/rev.]**

<b>3,5</b>	13	32	64	125
5	16	40	80	160
6,3	20	50	100	200
8	25	64	125	250
10	32			

**Size**

- 3 4 5 6 7

**Internal gear pump type**  
**IPV**

For identification data and identification size model IPH see individual catalogue G 1209.

For identification data and identification size model IPV see individual catalogue G 1485.

## Type IPC

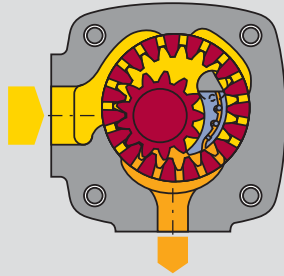

IPC 5 - 40 1 7 0 Example of order description

### Shaft end

- 0 Toothed shaft ANSI B92.1a
- 1 Feather key

### Fastening flange

- 0 SAE 2-hole
- 1 SAE 4-hole
- 4 VDMA 2-hole, DIN/ISO 3019/2
- 5 VDMA 4-hole, DIN/ISO 3019/2
- 7 SAE 2-hole (except for IPC 4 with differing centering diameter)

### Direction of rotation and suction

- 1 Clockwise rotation, radial suction mounting
- 6 Anti-clockwise rotation, radial suction mounting
- 4 Special design pumps, clockwise rotation
- 9 Special design pumps, anti-clockwise rotation

### Capacity [cm<sup>3</sup>/rev.]

20	40	80	160
25	50	100	200
32	64	125	250

### Size

4 5 6 7

Internal gear pump type  
IPC

## Type IPN

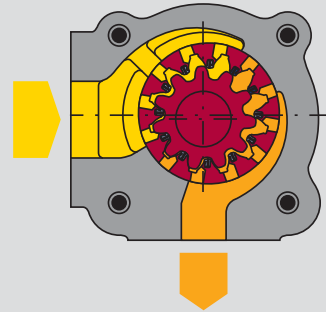

IPN 4 - 32 1 4 1 Example of order description

### Shaft end

- 0 Toothed shaft ANSI B92.1a
- 1 Feather key

### Fastening flange

- 0 SAE 2-hole
- 4 VDMA 2-hole, DIN/ISO 3019/2

### Direction of rotation and suction

- 1 Clockwise rotation, radial suction mounting
- 6 Anti-clockwise rotation, radial suction mounting
- 4 Special design pumps, clockwise rotation
- 9 Special design pumps, anti-clockwise rotation

### Capacity [cm<sup>3</sup>/rev.]

32	64	125
40	80	160
50	100	200

### Size

4 5 6

Internal gear pump type  
IPN

For identification data and identification size model IPC see individual catalogue G 1209.

For identification data and identification size model IPN see individual catalogue G 1418.

## 2. Multiple-flow pumps

### 2.1 Procedure for determining multiple-flow pumps

Please unfold page 29 to enter your order details.

- 1 Fill in the selected pump stages on the order details form; Assistance can be taken from the single pump catalogues
- 2 Check the torque with the assistance of the selecting criteria point 2.5
- 3 Select the intermediate housing, see selecting criteria point 2.6
- 4 Fill in the direction of rotation and suction points and order code
- 5 Selection of the fastening flange with order code (see single pump catalogue)
- 6 Selection of the end of the drive shaft
- 7 Points 1-6 form the complete order description
- 10/11 Connecting dimensions of two and three pump combinations see point 2.9 page 22
- 8/9 Selection of the suction or pressure flanges see single pump and/or intermediate housing

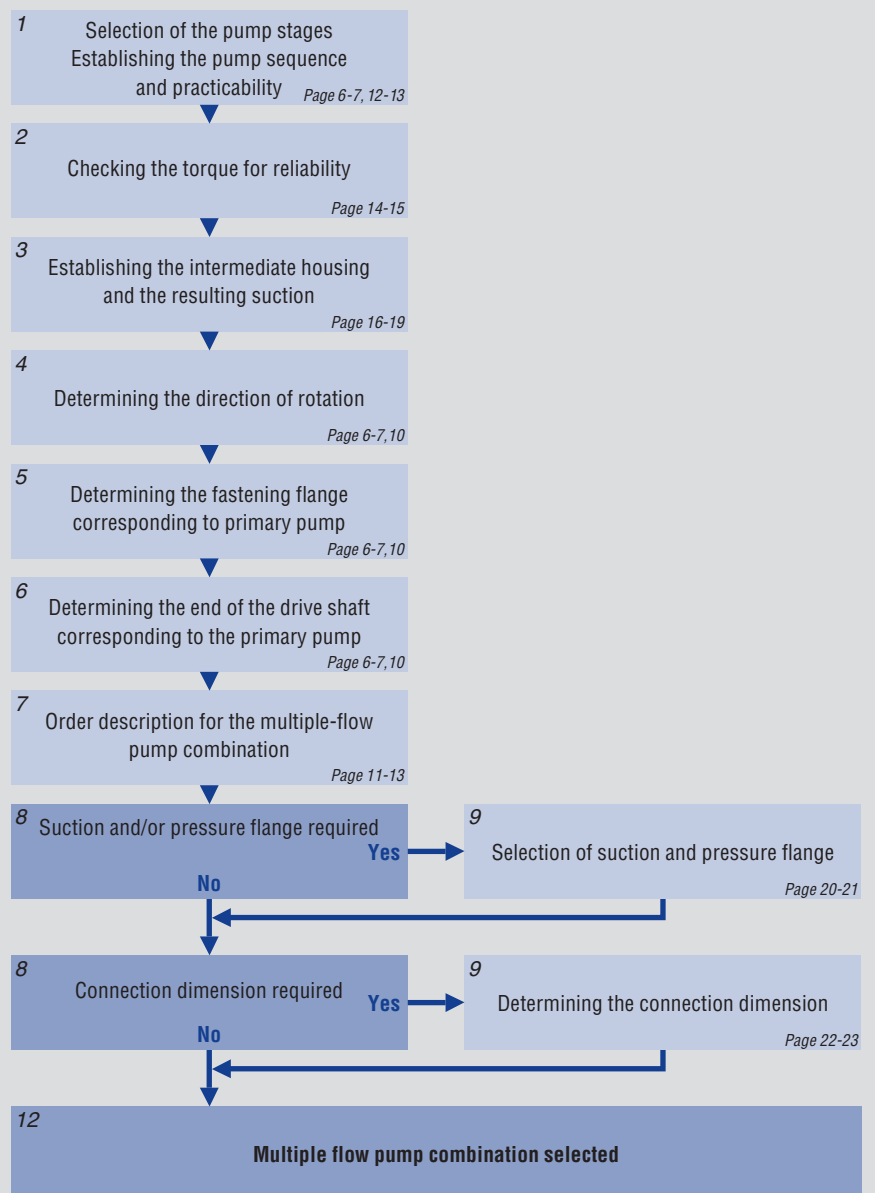



## 2.2 Determining pump sequence for multiple-flow pump combinations

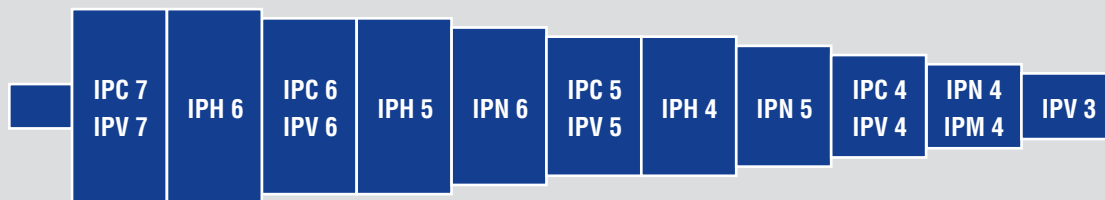

Sequence according to model and size

### Combining IP pumps

IP pumps of the same or of different sizes can be combined to multiple-flow pumps.

All sizes listed as single pumps with the respective capacities are available as two and three pump combinations ordered in ascending order according to size and flow-rate.

It is important to observe the sequence of pumps shown above according to model and size. It is possible to skip over sizes.

With the same models (V,C,N) and the same sizes (3,4,5,6,7) the pump with the bigger flow-rate is placed next to the drive.

Possible pump combination can be found out on table on page 12-13.

### Mounting and assembly

As a rule the multiple-flow pumps are fastened to the drive by means of fastening flanges. It is possible to select between different fastening flanges, see individual catalogues. The same applies to the shaft ends. The intermediate housings required can be found on pages 16 -19.

In addition to pump combinations of two or three pumps it is possible to combine four pumps, but this requires agreement from the manufacturers.













### Suction connections for multiple-flow pumps

With combinations of IPV and/or IPC pumps it is partly possible to select between suction connection at the intermediate housing and/or at the pump stages.

With IPN pumps the suction connection is always at the single pump.

# Designs

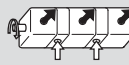
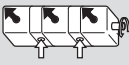
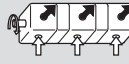
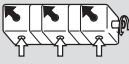
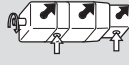
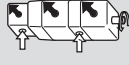
See individual catalogue for determination of the 3-digit design number for direction of rotation, suction, fastening flange, shaft end

Direction of rotation and suction	Fastening flange	Shaft end
<p>clockwise   anti-clockwise</p>  <div style="display: inline-block; border: 1px solid black; padding: 2px; margin: 0 10px;"><b>2</b></div> <div style="display: inline-block; border: 1px solid black; padding: 2px; margin: 0 10px;"><b>7</b></div> 	  	 
 <div style="display: inline-block; border: 1px solid black; padding: 2px; margin: 0 10px;"><b>1</b></div> <div style="display: inline-block; border: 1px solid black; padding: 2px; margin: 0 10px;"><b>6</b></div> 	<div style="display: inline-block; border: 1px solid black; padding: 2px; margin: 0 10px;"><b>0</b></div> <div style="display: inline-block; border: 1px solid black; padding: 2px; margin: 0 10px;"><b>1</b></div> <div style="display: inline-block; border: 1px solid black; padding: 2px; margin: 0 10px;"><b>1</b></div>	<div style="display: inline-block; border: 1px solid black; padding: 2px; margin: 0 10px;"><b>1</b></div> <div style="display: inline-block; border: 1px solid black; padding: 2px; margin: 0 10px;"><b>0</b></div>
 <div style="display: inline-block; border: 1px solid black; padding: 2px; margin: 0 10px;"><b>2</b></div> <div style="display: inline-block; border: 1px solid black; padding: 2px; margin: 0 10px;"><b>7</b></div> 	<div style="display: inline-block; border: 1px solid black; padding: 2px; margin: 0 10px;"><b>4</b></div> <div style="display: inline-block; border: 1px solid black; padding: 2px; margin: 0 10px;"><b>5</b></div> <div style="display: inline-block; border: 1px solid black; padding: 2px; margin: 0 10px;"><b>5</b></div>	
 <div style="display: inline-block; border: 1px solid black; padding: 2px; margin: 0 10px;"><b>1</b></div> <div style="display: inline-block; border: 1px solid black; padding: 2px; margin: 0 10px;"><b>6</b></div> 	<p>See individual pump sheets for designs and dimensions</p>	<p>See individual pump sheets for dimensions</p>
 <div style="display: inline-block; border: 1px solid black; padding: 2px; margin: 0 10px;"><b>3</b></div> <div style="display: inline-block; border: 1px solid black; padding: 2px; margin: 0 10px;"><b>8</b></div> 	<div style="display: inline-block; border: 1px solid black; padding: 2px; margin: 0 10px;"><b>0</b></div> SAE 2-hole flange <div style="display: inline-block; border: 1px solid black; padding: 2px; margin: 0 10px;"><b>1</b></div> SAE 4-hole flange	
 <div style="display: inline-block; border: 1px solid black; padding: 2px; margin: 0 10px;"><b>3</b></div> <div style="display: inline-block; border: 1px solid black; padding: 2px; margin: 0 10px;"><b>8</b></div> 	<div style="display: inline-block; border: 1px solid black; padding: 2px; margin: 0 10px;"><b>4</b></div> VDMA 2-hole flange <div style="display: inline-block; border: 1px solid black; padding: 2px; margin: 0 10px;"><b>5</b></div> VDMA 4-hole flange	
<p>Special design <div style="display: inline-block; border: 1px solid black; padding: 2px; margin: 0 10px;"><b>4</b></div> <div style="display: inline-block; border: 1px solid black; padding: 2px; margin: 0 10px;"><b>9</b></div> Special design</p>	<div style="display: inline-block; border: 1px solid black; padding: 2px; margin: 0 10px;"><b>7</b></div> SAE 2-hole flange	

(See individual catalogue G 1485, G 1209, G 1418 or page 6, 7 and 11)

## 2.3 Order description of multiple-flow pumps

### Two pump combination

Example of order description

IPV/N - 200/80 111

Pump 1: IPV 7-200 11

Pump 2: IPN /5-/80

IPV/N 7/5 - 200/80 1 1 1

#### Shaft end

1 Cylinder shaft end with feather key

#### Fastening flange

1 SAE 4-hole-flange

#### Direction of rotation and suction

1 one suction connection per pump stage

Is determined according to required intermediate housing. Clockwise rotation

Flow rate of the individual pump stages see point 2.2 to 2.5 of the individual pumps.

200 80

Size of the individual pump stages.

7 5

Two internal gear pump combination consisting of  
Type IPV, IPN

Exception:

If all pump stages are the same pump model use the model in the order description only once.

Example: IPV 5/3-50/10 111

Pump 1: IPV 5-50 111

Pump 2: IPV /3-/10

### Three pump combination

Example of order description

IPV/N/V - 200/80/10 111

Pump 1 IPV 7-200 11

Pump 2: IPN /5-/80

Pump 3: IPV /3-/10

IPV/N/V 7/5/3 - 200/80/10 1 1 1

#### Shaft end

1 Cylinder shaft end with feather key

#### Fastening flange

1 SAE 4-hole-flange

#### Direction of rotation and suction

1 one suction connection per pump stage

Is determined according to required intermediate housing. Clockwise rotation

Flow rate of the individual pump stages see point 2.2 to 2.5 of the individual pumps.

200 80 10

Size of the individual pump stages.

7 5 3

Two internal gear pump combination consisting of  
Typ IPV, IPN

Exception:

If all pump stages are the same pump model use the model in the order description only once.

Example: IPV 5/4/3-64/25/8 211



Pump 1: IPV 5-64 211

Pump 2: IPV /4-/25

Pump 3: IPV /3-/8

## 2.4 Possible pump combinations of two or more pumps

● Example of selection IPV/N/V 7/5/3-200/80/10 111.

-  Possible pump combinations
-  Pump sequence in any order (as chosen) with the same model size sequence of the flow rates in any order (as chosen).

	Pump 2	IPV /3	IPV /4	IPV /5	IPV /6	IPV /7	IPC /4	IPC /5
<b>Pump 1</b>	Capacity [cm <sup>3</sup> /U]	3,5-5-6,3-8-10 ●	13-16-20-25-32	32-40-50-64	64-80-100-125	125-160-200-250	20-25-32	40-50-64
<b>IPV 3 IPV /3</b>	3,5-5-6,3-8-10	IPV 3/3-... IPV /3/3-...						
<b>IPV 4 IPV /4</b>	13-16-20-25-32	IPV 4/3-... IPV /4/3-...	IPV 4/4-... IPV /4/4-...				IPV/C 4/4-... IPV/C /4/4-...	
<b>IPV 5 IPV /5</b>	32-40-50-64	IPV 5/3-... IPV /5/3-...	IPV 5/4-... IPV /5/4-...	IPV 5/5-... IPV /5/5-...			IPV/C 5/4-... IPV/C /5/4-...	IPV/C 5/5-... IPV/C /5/5-...
<b>IPV 6 IPV /6</b>	64-80-100-125	IPV 6/3-... IPV /6/3-...	IPV 6/4-... IPV /6/4-...	IPV 6/5-... IPV /6/5-...	IPV 6/6-... IPV /6/6-...		IPV/C 6/4-... IPV/C /6/4-...	IPV/C 6/5-... IPV/C /6/5-...
<b>IPV 7 IPV /7</b>	125-160-200-250 ●	IPV 7/3 IPV /7/3-...	IPV 7/4-... IPV /7/4-...	IPV 7/5-... IPV /7/5-...	IPV 7/6-... IPV /7/6-...	IPV 7/7-... IPV /7/7-...	IPV/C 7/4-... IPV/C /7/4-...	IPV/C 7/5-... IPV/C /7/5-...
<b>IPC 4 IPC /4</b>	20-25-32	IPC/V 4/3-... IPC/N /4/3-...	IPC/V 4/4-... IPC/N /4/4-...				IPC 4/4-... IPC /4/4-...	
<b>IPC 5 IPC /5</b>	40-50-64	IPC/V 5/3-... IPC/N /5/3-...	IPC/V 5/4-... IPC/N /5/4-...	IPC/V 5/5-... IPC/N /5/5-...			IPC 5/4-... IPC /5/4-...	IPC 5/5-... IPC /5/5-...
<b>IPC 6 IPC /6</b>	80-100-125	IPC/V 6/3-... IPC/N /6/3-...	IPC/V 6/4-... IPC/N /6/4-...	IPC/V 6/5-... IPC/N /6/5-...	IPC/V 6/6-... IPC/N /6/6-...		IPC 6/4-... IPC /6/4-...	IPC 6/5-... IPC /6/5-...
<b>IPC 7 IPC /7</b>	160-200-250	IPC/V 7/3-... IPC/N /7/3-...	IPC/V 7/4-... IPC/N /7/4-...	IPC/V 7/5-... IPC/N /7/5-...	IPC/V 7/6-... IPC/N /7/6-...	IPC/V 7/7-... IPC/N /7/7-...	IPC 7/4-... IPC /7/4-...	IPC 7/5-... IPC /7/5-...
<b>IPH 4 IPH /4</b>	20-25-32	IPH/V 4/3-... IPH/N /4/3-...	IPH/V 4/4-... IPH/N /4/4-...				IPH/C 4/4-... IPH/C /4/4-...	
<b>IPH 5 IPH /5</b>	40-50-64	IPH/V 5/3-... IPH/N /5/3-...	IPH/V 5/4-... IPH/N /5/4-...				IPH/C 5/4-... IPH/C /5/4-...	IPH/C 5/5-... IPH/C /5/5-...
<b>IPH 6 IPH /6</b>	80-100-125	IPH/V 6/3-... IPH/N /6/3-...	IPH/V 6/4-... IPH/N /6/4-...				IPH/C 6/4-... IPH/C /6/4-...	IPH/C 6/5-... IPH/C /6/5-...
<b>IPN 4 IPN /4</b>	32-40-50	IPN/V 4/3-... IPN/N /4/3-...						
<b>IPN 5 IPN /5</b>	64-80-100 ●	IPN/V 5/3-... IPN/V /5/3-... ●	IPN 5/4-... IPN /5/4-...				IPN/C 5/4-... IPN/C /5/4-...	
<b>IPN 6 IPN /6</b>	125-160-200	IPN/V 6/3-... IPN/V /6/3-...	IPN/V 6/4-... IPN/V /6/4-...	IPN/V 6/5-... IPN/V /6/5-...			IPN/C 6/4-... IPN/C /6/4-...	IPN/C 6/5-... IPN/C /6/5-...

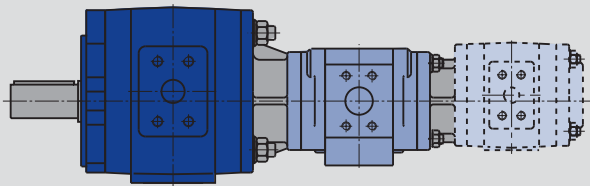

Pump 1

Pump 2

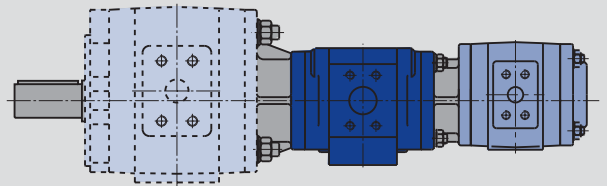

Pump 1

Pump 2

	IPC /6	IPC /7	IPH /4	IPH /5	IPH /6	IPN /4	IPN /5	IPN /6
4	80-100-125	160-200-250	20-25-32	40-50-64	80-100-125	32-40-50-64	64-80-100	125-160-200
						IPV/N 4/4-... IPV/N /4/4-...		
						IPV/N 5/4-... IPV/N /5/4-...	IPV/N 5/5-... IPV/N /5/5-...	
	IPV/C 6/6-... IPV/C /6/6-...					IPV/N 6/4-... IPV/N /6/4-...	IPV/N 6/5-... IPV/N /6/5-...	IPV/N 6/6-... IPV/N /6/6-...
	IPV/C 7/6-... IPV/C /7/6-...	IPV/C 7/7-... IPV/C /7/7-...				IPV/N 7/4-... IPV/N /7/4-...	IPV/N 7/5-... IPV/N /7/5-...	IPV/N 7/6-... IPV/N /7/6-...
						IPC/N 4/4-... IPC/N /4/4-...		
			IPC/H 5/4-... IPC/H /5/4-...			IPC/N 5/4-... IPC/N /5/4-...	IPC/N 5/5-... IPC/N /5/5-...	
	IPC 6/6-... IPC /6/6-...		IPC/H 6/4-... IPC/H /6/4-...	IPC/H 6/5-... IPC/H /6/5-...		IPC/N 6/4-... IPC/N /6/4-...	IPC/N 6/5-... IPC/N /6/5-...	IPC/N 6/6-... IPC/N /6/6-...
	IPC 7/6-... IPC /7/6-...	IPC 7/7-... IPC /7/7-...	IPC/H 7/4-... IPC/H /7/4-...	IPC/H 7/5-... IPC/H /7/5-...	IPC 7/6-... IPC/H /7/6-...	IPC/N 7/4-... IPC/N /7/4-...	IPC/N 7/5-... IPC/N /7/5-...	IPC/N 7/6-... IPC/N /7/6-...
			IPH 4/4-... IPH /4/4-...			IPH/N 4/4-... IPH/N /4/4-...	IPH/N 4/5-... IPH/N /4/5-...	
			IPH 5/4-... IPH /5/4-...	IPH 5/5-... IPH /5/5-...		IPH/N 5/4-... IPH/N /5/4-...	IPH/N 5/5-... IPH/N /5/5-...	IPH/N 5/6-... IPH/N /5/6-...
	IPH/C 6/6-... IPH/C /6/6-...		IPH 6/4-... IPH /6/4-...	IPH 6/5-... IPH /6/5-...	IPH 6/6-... IPH /6/6-...	IPH/N 6/4-... IPH/N /6/4-...	IPH/N 6/5-... IPH/N /6/5-...	IPH/N 6/6-... IPH/N /6/6-...
						IPN 4/4-... IPN /4/4-...		
						IPN 5/4-... IPN /5/4-...	IPN 5/5-... IPN /5/5-...	
			IPN/H 6/4-... IPN/H /6/4-...			IPN 6/4-... IPN /6/4-...	IPN 6/5-... IPN /6/5-...	IPN 6/6-... IPN /6/6-...

**dark blue:** primary pump at double pumps  
first secondary pump at triple pumps

**light blue:** first secondary pump at double pumps  
second secondary pump at triple pumps

## 2.5 Torque control

**With pump combinations of three or more pumps the torque occurring between the pump stages can reach high values that are not permissible and, if left unheeded, will lead to damage to the pumps! The sum of the torques of the single pump stages may not exceed the permissible values!**

**The following procedure is to check and calculate the torque values.**

### 2.5.1 Calculation of the torque of a hydraulic pump

$$M_d = \frac{V_{gth} \cdot \Delta p}{2\pi \cdot 10}$$

$M_d$  = input torque in Nm

$V_{gth}$  = capacity in cm<sup>3</sup>/rev.

$\Delta p$  = pressure in bar

### 2.5.2 Calculation of the total torque of a pump combination

$$M_{dges} = M_{dA} + M_{dB} + M_{dC}$$

$M_{dA}$  = input torque A pump (1<sup>st</sup> pump)

$M_{dB}$  = input torque B pump (2<sup>nd</sup> pump)

$M_{dC}$  = input torque C pump (3<sup>rd</sup> pump)

The maximum permissible torque at each secondary shaft can be taken from table 3.5.4.

The torque at the secondary shaft of the B pump is the critical torque:  $M_{dsekB} = M_{dB} + M_{dC}$

### 2.5.3 Torque calculation at the secondary shaft (connecting sleeves)

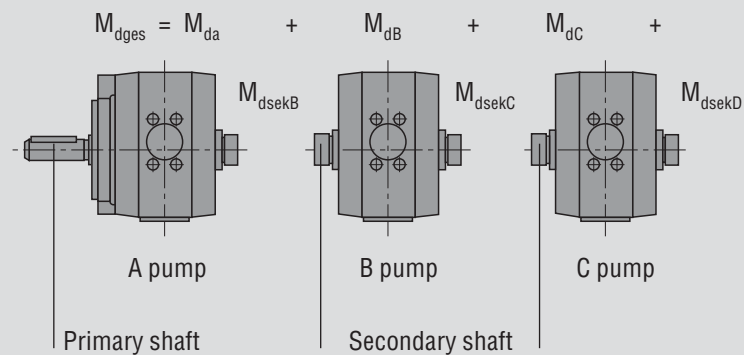

## 2.5.4 Permissible input torques for Voith internal gear pumps



If the check shows that the permissible values are exceeded it is primary to check whether the pressures occur at the same time.

If necessary please contact Voith.

Permissible input torque $M_d$ in Nm			
Type	Primary shaft	Secondary shaft	
<b>IPH 4</b>	450	300	
<b>IPH 5</b>	800	540	
<b>IPH 6</b>	1,350	800	
<b>IPV 3</b>	160	80	
<b>IPV 4</b>	335	190	
<b>IPV 5</b>	605	400	
<b>IPV 6</b>	1,050	780	
<b>IPV 7</b>	1,960	1,200	
<b>IPC 4</b>	335	190	
<b>IPC 5</b>	605	400	
<b>IPC 6</b>	1,050	780	
<b>IPC 7</b>	1,960	1,200	
<b>IPN 4</b>	160	100	
<b>IPN 5</b>	295	200	
<b>IPN 6</b>	605	400	

## 2.6 Determining the intermediate housing

● Example of selection IPV/N/V 7/5/3-200/80/10 111.

	Suction only via pump stages
	Suction only via intermediate housing
	Suction only possible via intermediate housing or pump stages

	Pump 2	IPV /3	IPV /4	IPV /5	IPV /6	IPV /7	IPC /4	IPC /5
<b>Pump 1</b>	Capacity [cm <sup>3</sup> /U]	3,5-5-6,3-8-10 ●	13-16-20-25-32	32-40-50-64	64-80-100-125	125-160-200-250	20-25-32	40-50-64
<b>IPV 3</b> IPV /3	3,5-5-6,3-8-10	101						
<b>IPV 4</b> IPV /4	13-16-20-25-32	102	103				103	
<b>IPV 5</b> IPV /5	32-40-50-64	104	105	106			105	106
<b>IPV 6</b> IPV /6	64-80-100-125	107	108	109	110 231		108	109
<b>IPV 7</b> IPV /7	125-160-200-250 ●	111	112	113	114	115 232	112	113
<b>IPC 4</b> IPC /4	20-25-32	102	103				103	
<b>IPC 5</b> IPC /5	40-50-64	104	105	106			105	106
<b>IPC 6</b> IPC /6	80-100-125	107	108	109	110 231		108	109
<b>IPC 7</b> IPC /7	160-200-250	111	112	113	114	115 232	112	113
<b>IPH 4</b> IPH /4	20-25-32	122	123				123	
<b>IPH 5</b> IPH /5	40-50-64	124	125				125	128
<b>IPH 6</b> IPH /6	80-100-125	126	127				127	129
<b>IPN 4</b> IPN /4	32-40-50	201						
<b>IPN 5</b> IPN /5	64-80-100 ●	202 ●	203				203	
<b>IPN 6</b> IPN /6	125-160-200	204	205	206			205	206



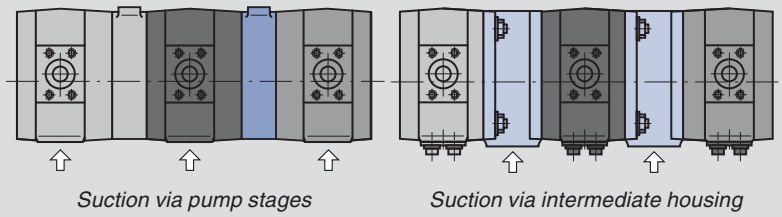

	IPC /6	IPC /7	IPH /4	IPH /5	IPH /6	IPN /4	IPN /5	IPN /6
4	80-100-125	160-200-250	20-25-32	40-50-64	80-100-125	32-40-50-64	64-80-100	125-160-200
						208		
						209	210	
	110	231				211	212	213
	114	115				214	215	216
		232				208		
			116			209	210	
	106		117	118	233	211	212	213
	109	115	119	120	121	214	215	216
		232			234			
	113		131			217	218	
			235			219	220	221
			132	133	236	222	223	224
	130		134	135	136	225		
					237	226	227	
						228	229	230
			207					

## 2.7 Dimensions of intermediate housing for multiple-flow pumps

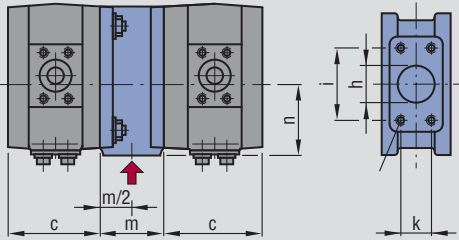

Intermediate housing with joint suction from 2 pump stages, the same size.

Selection of the intermediate housing see point 2.6.

No.	m	m/2	n	h	i	k	l	SAE suction flange No.
101	45	22.5	65	25	52.4	26.2	M 10x15 deep	12
103	66	33	70	40	70	36	M 12x20 deep	30
106	90	45	82	60	89	50.8	M 12x20 deep	16
110	110	55	100	76	106.3	62	M 16x25 deep	17
115	140	70	120	100	130.2	77.8	M 16x25 deep	18
116	90	45	82	60	89	50.8	M 12x20 deep	16
118	110	55	100	76	106.3	62	M 16x25 deep	17
121	140	70	120	100	130.2	77.8	M 16x25 deep	18
131	70	35	74.3	40	70	36	M 12x20 deep	14
133	90	45	90	60	89	50.8	M 12x20 deep	16
136	110	55	110	76	106.3	62	M 16x25 deep	17

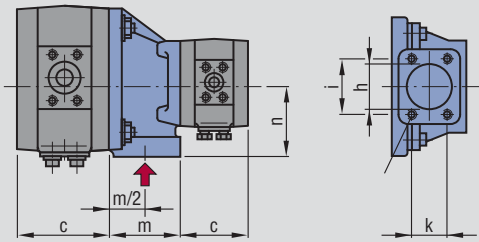

Intermediate housing with joint suction from 2 pump stages of different sizes.

No.	m	m/2	n	h	i	k	l	SAE suction flange No.
102	66	33	70	40	70	36	M 12x20 deep	30
104	80	40	82	50	77.8	42.9	M 12x20 deep	15
105	90	45	82	60	89	50.8	M 12x20 deep	16
107	90	45	90	60	89	50.8	M 12x20 deep	16
108	110	55	110	76	106.3	62	M 16x25 deep	17
109	110	55	110	76	106.3	62	M 16x25 deep	17
111	110	55	110	76	106.3	62	M 16x25 deep	17
112	110	55	110	76	106.3	62	M 16x25 deep	17
113	110	55	110	76	106.3	62	M 16x25 deep	17
114	140	70	120	100	130.2	77.8	M 16x25 deep	18
117	110	55	100	76	106.3	62	M 16x25 deep	17
119	110	55	110	76	106.3	62	M 16x25 deep	17
120	110	55	100	76	106.3	62	M 16x25 deep	17
122	66	33	74.3	40	70	36	M 12x20 deep	30
123	70	35	74.3	40	70	36	M 12x20 deep	30
124	80	40	90	50	77.8	42.9	M 12x20 deep	15
125	90	45	90	60	89	50.8	M 12x20 deep	16
126	90	45	110	60	89	50.8	M 12x20 deep	16
127	110	55	110	76	106.3	62	M 16x25 deep	17
128	90	45	90	60	89	50.8	M 12x20 deep	16
129	110	45	110	76	106.3	62	M 16x25 deep	17
130	110	55	110	76	106.3	62	M 16x25 deep	17
132	90	45	90	60	89	50.8	M 12x20 deep	16
134	110	55	110	76	106.3	62	M 16x25 deep	17
135	110	55	110	76	106.3	62	M 16x25 deep	17

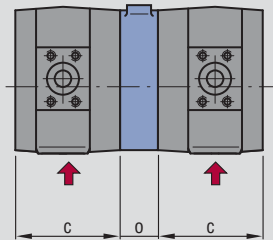

Intermediate housing with separate suction from 2 pump stages, the same size.

No.	o
201	46
203	60
206	64
208	52
210	64
213	72
225	48
227	62
230	67
231	55
232	56
233	55
234	56
235	48
236	55
237	56

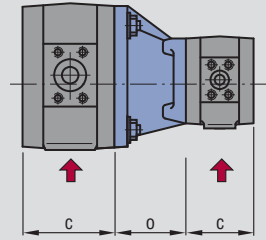

Intermediate housing with separate suction from 2 pump stages, different sizes.

No.	o
202	50
204	58
205	64
207	64
209	60
211	60
212	70
214	60
215	70
216	72
217	60
218	64
219	60
220	70
221	72
222	60
223	70
224	72
226	54
228	63
229	66

● Example of selection

## 2.7.1 SAE mounting flange

Suction flange no.																			
	Capacity																		
	3,5	5	6,3	8	10	13	16	20	25	32	40	50	64	80	100	125	160	200	250
IPV 3	10	10	11	11	12														
IPV 4						12	12	13	13	13									
IPV 5										13	30	30	30						
IPV 6													30	15	15	15			
IPV 7																15	16	16	17
IPC 4								13	13	13									
IPC 5											30	30	30						
IPC 6														15	15	15			
IPC 7																	16	16	17
IPH 4								13	13	13									
IPH 5											30	30	30						
IPH 6														15	15	15			
IPN 4										13	30	30							
IPN 5													30	15	15				
IPN 6																15	16	17	
Pressure flange no.																			
	Capacity																		
	3,5	5	6,3	8	10	13	16	20	25	32	40	50	64	80	100	125	160	200	250
IPV 3	10	10	10	10	10														
IPV 4						10	10	11	11	11									
IPV 5										11	12	12	12						
IPV 6													12	14	14	14			
IPV 7																14	14	14	14
IPC 4								11	11	11									
IPC 5											12	12	12						
IPC 6														14	14	14			
IPC 7																	14	14	14
IPH 4								11	11	11									
IPH 5											12	12	12						
IPH 6														14	14	14			
IPN 4										12	12	13							
IPN 5													13	13	30				
IPN 6																30	30	15	

## 2.8 SAE suction and pressure flanges corresponding SAE J 518c, Code 61

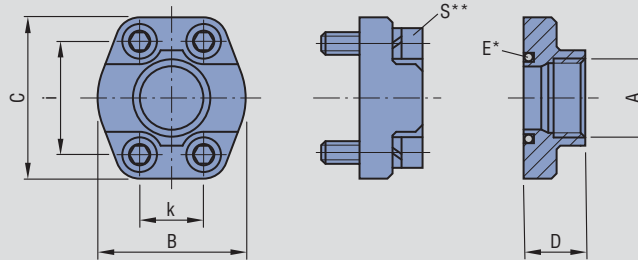

### One-piece SAE flange

Flange no.	Dimensions								
	A	B	C	D	E*	i	k	S**	perm. pressure [bar]
10	G 1/2"	46	54	36	18.66 – 3.53	38.1	17.5	M 8	345
11	G 3/4"	50	65	36	24.99 – 3.53	47.6	22.2	M 10	345
12	G 1"	55	70	38	32.92 – 3.53	52.4	26.2	M 10	345
13 <sup>1)</sup>	G 1 1/4"	68	79	41	37.69 – 3.53	58.7	30.2	M 10	276
14	G 1 1/2"	82	98	50	47.22 – 3.53	70	36	M 12	345 <sup>1)</sup>
30	G 1 1/2"	78	93	50	47.22 – 3.53	70	36	M 12	207
15	G 2"	90	102	45	56.74 – 3.53	77.8	42.9	M 12	207
16	G 2 1/2"	105	114	50	69.44 – 3.53	89	50.8	M 12	172
17	G 3"	124	134	50	85.32 – 3.53	106.3	62	M 16	138
18	G 4"	146	162	48	110.72 – 3.53	130	77.8	M 16	34

Scope of supply: flange, O-ring, fillister head cap screw and spring washers.

\* O-Ring ISO-R 1629 NBR (Buna N)

\*\* Fillister head cap screw DIN 912, material 8.8

<sup>1)</sup> Voith special design, differing from SAE J 518 C Code 61

## 2.9 Dimension chains for pump combinations calculation of total length

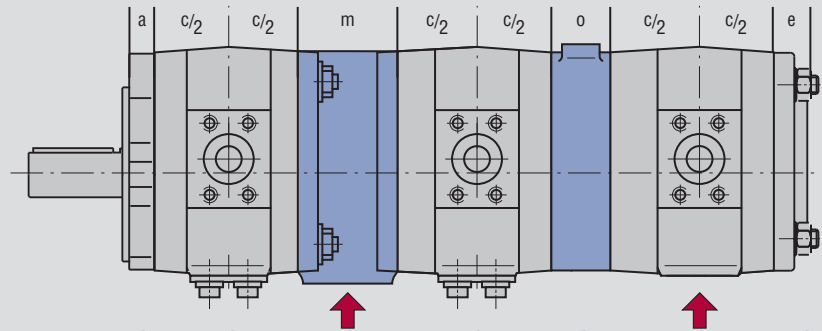

Flange thickness "a" primary pump

Length of housing "c" primary pump

Length dimension "m/o" intermediate housing  
Primary/secondary pump shown "m" with suction

Length of housing "c" 1<sup>st</sup> B-stage

Length dimension "m/o" intermediate housing  
1<sup>st</sup> B-stage / 2<sup>nd</sup> B-stage depending on suction, shown "o" without suction

Length of housing "c" 2<sup>nd</sup> B-stage

End cover "e" of the 2<sup>nd</sup> B-stage

The example shows a combination of three pumps.

The dimensions for a combination of two pumps can be determined correspondingly.

- Dimension "a" thickness of flange see individual catalogue G 1485 or table 2.9.1.
- Length of housing "c" see individual catalogue G 1485, G 1209, G 1418 or the following table.
- Length dimension intermediate housing "m" or "o" see pages 18/19 depending on suction.
- Dimension "e" end cover see individual catalogue G 1485 or the following table.

### 2.9.1 Length dimensions of Voith IP pumps [mm]

IPV					IPC				
Size	cm <sup>3</sup> /rev.	"a"	"c"	"e"	Size	cm <sup>3</sup> /rev.	"a"	"c"	"e"
3	3.5	19.5	66	20.5					
	5		70						
	6.3		73						
	8		77.5						
	10		82.5						
4	13	26	88.5	31	4		18		25
	16		92.5						
	20		98						
	25		104						
	32		113						
5	32	20	119	36	5		20		31
	40		125						
	50		132						
	64		143						
6	64	22	140	40	6		22		35
	80		148	35					
	100		158	40					
	125		170	40					
7	125	63	152	48	7		63		48
	160		162	16					
	200		174	42					
	250		188	42					
IPH					IPN				
Size	cm <sup>3</sup> /rev.	"a"	"c"	"e"	Size	cm <sup>3</sup> /rev.	"a"	"c"	"e"
(2)	3.5	19	64	19.5					
	5		69						
	6.3		73						
	8		78						
(3)	10	22	88	25					
	13		94						
	16		99						
4	20	20	102	36	4		20	100.5	31
	25		108					113.5	
	32		116					130	
5	40	22	138	35	5		26	119.5	33.5
	50		145					135	
	64		155					155	
	80		171					151	
6	80	26	171	47	6		24	172.5	40
	100		181					172.5	
	125		193					197	
	125		193					197	

"a" = Thickness of flange  
 "c" = Length of housing  
 "e" = Thickness of cover

# 3 Combining Voith IP pumps with pumps from other manufacturers

## 3.1 Mounting pumps from other manufacturers on to Voith IP pumps

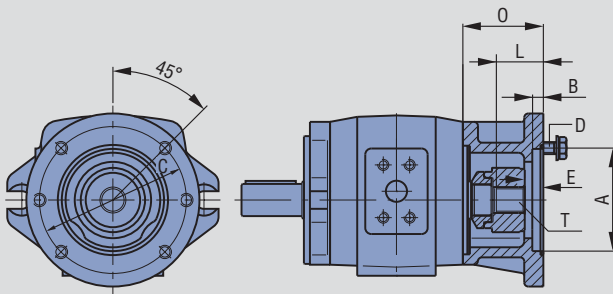

$L$  = Max. possible shaft length  
 $T$  = Tooth number of the toothed hub with involute flank (ANSI B 92, 1a) pressure angle  $30^\circ$

Dimensions for Voith internal gear pumps IPV 4 to 7, IPC 4 to 7 and IPH 4 to 6 can be taken from the dimension sheet for the individual pump, dimensions for pumps of other designs can be taken from the respective manufacturer's catalogue.

The choice of possibilities for mounting flange and shaft end correspond to the data on the single pump sheets.

Combinations of Voith internal gear pumps model IPN with pumps from other manufacturers on request.

Type	Intermediate housing	O	A	B	C	D	O-Ring	E	L	T	Pitch
IPC 4	100	64	82,55 <sup>G7</sup>	7	106,5±0,3	M 10	83x3	18	38	11	16/32
IPH 4 IPV 5 IPC 5	101	80	82,55 <sup>G7</sup>	8	106,5±0,3	M 10	83x3	18	38	11	16/32
IPH 5 IPV 6 IPC 6	102	92	82,55 <sup>G7</sup>	8	106,5±0,3	M 10	83x3	18	38	11	16/32
IPH 6 IPV 7 IPC 7	103	92	82,55 <sup>G7</sup>	8	106,5±0,3	M 10	83x3	18	38	11	16/32
IPH 4 IPV 5 IPC 5	104	80	101,6 <sup>G7</sup>	10	146±0,3	M 12	102x3	17	41	13	16/32
IPH 5 IPV 6 IPC 6	105	92	101,6 <sup>G7</sup>	10	146±0,3	M 12	102x3	17	41	13	16/32
IPH 6 IPV 7 IPC 7	106	92	101,6 <sup>G7</sup>	10	146±0,3	M 12	102x3	17	41	13	16/32
IPV 5 IPC 5	107	80	101,6 <sup>G7</sup>	10	146±0,3	M 12	102x3	17,5	46	15	16/32
IPH 5 IPV 6 IPC 6	108	92	101,6 <sup>G7</sup>	10	146±0,3	M 12	102x3	17,5	46	15	16/32
IPH 6 IPV 7 IPC 7	109	92	101,6 <sup>G7</sup>	10	146±0,3	M 12	102x3	17,5	46	15	16/32
IPH 5 IPV 6 IPC 6	110	92	127 <sup>G7</sup>	13	181±0,3	M 16	126x3	8	59	14	12/24
IPH 6 IPV 7 IPC 7	111	92	127 <sup>G7</sup>	13	181±0,3	M 16	126x3	8	59	14	12/24
IPV 6 IPC 6	112	92	127 <sup>G7</sup>	13	181±0,3	M 16	126x3	8	63	17	12/24
IPH 6 IPV 7 IPC 7	113	92	127 <sup>G7</sup>	13	181±0,3	M 16	126x3	8	63	17	12/24
IPV 7 IPC 7	114	150	152,4 <sup>G7</sup>	13	228,6±0,3	M 18	150x3	8	118	13	8/16

Fastening bolts and O-ring are part of the Voith scope of supply.







### 3.1.1 Intermediate housing with coupling

Combinations consisting of Voith internal gear pumps model IPV, IPC or IPH and intermediate housing with coupling, suitable for mounting of pumps with mounting flange to DIN ISO 3019-1 and drive shaft with involute splining to ANSI B 92.1a.

#### Ordering example

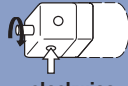
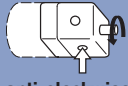
IPV 5-50 with intermediate housing 104 rotating clockwise with SAE-2-hole flange and cylindrical drive shaft with feather key.

**IPV 5/104-50/... 101**

Type	Intermedi-ate housing	Direction of rotation and suction		Mounting flange*		Shaft end*
		 clockwise 1	 anti-clockwise 6	 0	 1	 1
IPC 4	100	1	6	0	1	1
IPH 4 IPV 5 IPC 5	101	1	6	0	1	1
IPH 5 IPV 6 IPC 6	102	1	6	0	1	1
IPH 6 IPV 7 IPC 7	103	1	6	0	1	1
IPH 4 IPV 5 IPC 5	104	1	6	0	1	1
IPH 5 IPV 6 IPC 6	105	1	6	0	1	1
IPH 6 IPV 7 IPC 7	106	1	6	0	1	1
IPV 5 IPC 5	107	1	6	0	1	1
IPH 5 IPV 6 IPC 6	108	1	6	0	1	1
IPH 6 IPV 7 IPC 7	109	1	6	0	1	1
IPH 5 IPV 6 IPC 6	110	1	6	0	1	1
IPH 6 IPV 7 IPC 7	111	1	6	0	1	1
IPV 6 IPC 6	112	1	6	0	1	1
IPH 6 IPV 7 IPC 7	113	1	6	0	1	1
IPV 7 IPC 7	114	1	6	0	1	1

\* Further possibilities of selection see dimension sheets for the single pumps.

## 3.2 Mounting Voith IP pumps on to pumps from other manufacturers

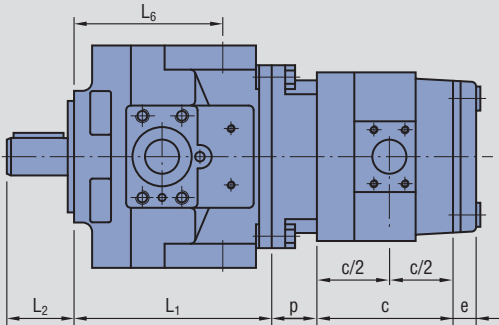

**Dimensions table 1 (RKP)**

Type	L <sub>1</sub>	L <sub>2</sub>	L <sub>6</sub>	Supplier
RKP 16 RKP 19	See Moog data sheets for dimensions			Moog
RKP 32 RKP 45	See Moog data sheets for dimensions			Moog
RKP 63 RKP 80	See Moog data sheets for dimensions			Moog
RKP 90 RKP 100	See Moog data sheets for dimensions			Moog
RKP 140 RKP 110	See Moog data sheets for dimensions See Wepuko data sheets for dimensions			Moog Wepuko
RKP 125 RKP 160	See Wepuko data sheets for dimensions			Wepuko
RKP 180 RKP 250	See Wepuko data sheets for dimensions			Wepuko

Mounting Voith internal gear pumps on to

- Wepuko radial piston pumps
- Moog adjustable piston pumps, only with heavy through-drive
- Combinations of IPN with radial piston pumps on request.

**Dimensions table 2 (length of intermediate flange) and description of intermediate flange**

Type	RKP 16/19		RKP 32/45		RKP 63/80/90/100		RKP 140		RKP 110/125/160/180		RKP 250	
	p	Des.	p	Des.	p	Des.	p	Des.	p	Des.	p	Des.
IPV 3	50	500	50	501	50	502	50	503	17	–	17	–
IPC 4/IPV 4	–	–	55	504	55	505	55	506	17	–	17	–
IPC 5/IPV 5	–	–	55	507	55	508	55	509	40	–	17	–
IPC 6/IPV 6	–	–	–	–	55	510	55	511	66.5	–	72.5	–
IPC 7/IPV 7	–	–	–	–	–	–	56	512	66.5	–	72.5	–

Please refer to the data sheet for the single pumps for IP dimensions.

### Ordering example

for mounting pump, intermediate housing and drive shaft.

**IPV /5 508-/40 129**

**IPV /5/5 508-/50/40 229**

	RKP 110 to 250	RKP 16 to 140
Supplier RKP	Wepuko	Moog
Supplier of mounting parts	Wepuko	Voith
Supplier of IP pump	Voith	Voith

Dimensions of the RKP pumps L<sub>1</sub>, L<sub>2</sub>, L<sub>6</sub> are to be requested from the respective manufacturers.

### 3.2.1 Order description for Voith IPV pumps on to pumps from other manufacturers

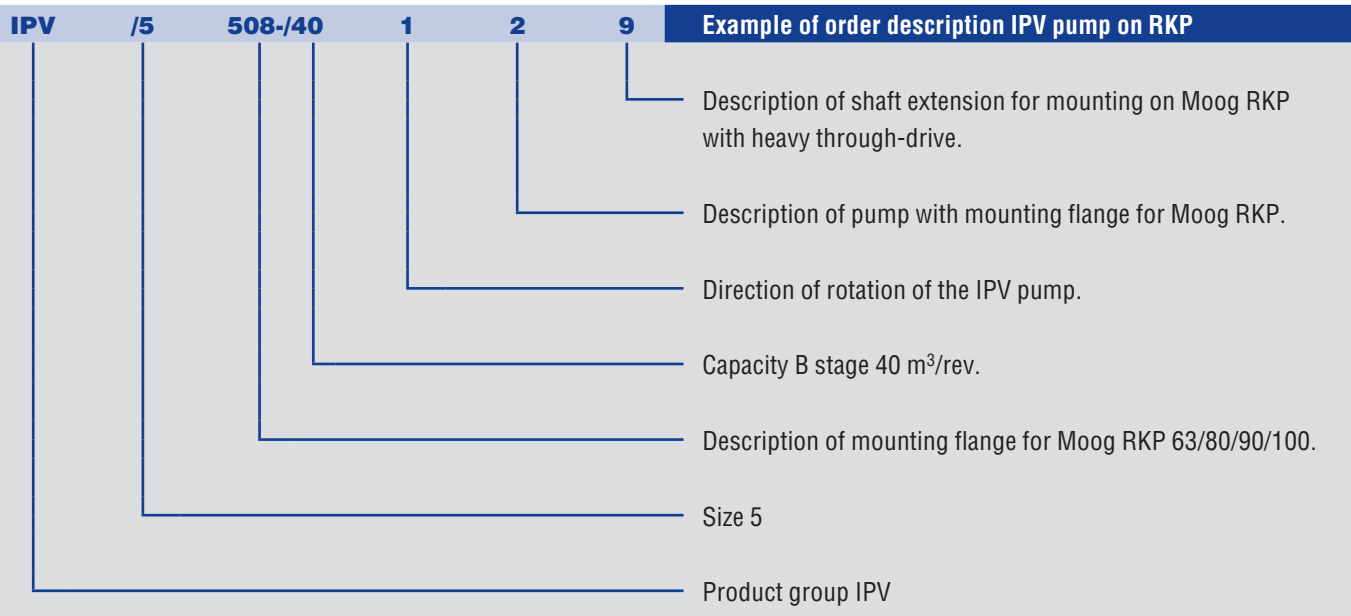

IPV /5/5 508-50/40 229	Example of order description for combination of two IPV pumps on RKP
IPV	Product group
/5	Size 1 <sup>st</sup> B-stage
/5	Size 2 <sup>nd</sup> B-stage
/50	Capacity 1 <sup>st</sup> B-stage
/40	Capacity 2 <sup>nd</sup> B-stage
2	Direction of rotation clockwise, joint suction for IPV 5/5.
2	Description of pump with mounting flange for Moog RKP.
9	Description of shaft extension for mounting on Moog RKP with heavy through-drive.



# Order details

Original form for copying

**Pump 1** Continuous pressure in system \_\_\_\_\_ bar Maximum pressure in system \_\_\_\_\_ bar Capacity/rev. \_\_\_\_\_  
**Pump 2** Continuous pressure in system \_\_\_\_\_ bar Maximum pressure in system \_\_\_\_\_ bar Capacity/rev. \_\_\_\_\_  
**Pump 3** Continuous pressure in system \_\_\_\_\_ bar Maximum pressure in system \_\_\_\_\_ bar Capacity/rev. \_\_\_\_\_

Internal gear pumps		Sizes	Capacity	Direction of rotation Suction	Fastening flange	Shaft end
<b>Pre-selection</b>	Primary pump IP <input type="text"/>	<input type="text"/>	<input type="text"/>	Order code / <input type="text"/>		
<b>Pump</b>	1 <sup>st</sup> B pump IP <input type="text"/>	<input type="text"/>	<input type="text"/>			
<b>sequence</b>	2 <sup>nd</sup> B pump IP <input type="text"/>	<input type="text"/>	<input type="text"/>			
<b>Direction of rotation</b> anti-clockwise, clockwise						
<b>Suction connection</b> joint, separate, mixed						
<p style="text-align: center;">Direction of rotation and suction</p> <p style="text-align: center;">clockwise  anti-clockwise </p> <p style="text-align: center;">Special design <input type="text"/> <input type="text"/> Special design</p>						
<b>Intermediate housing</b>	Intermediate housing no. _____ / _____					
<b>Torque control</b>	Maximum torque occurring at secondary shaft _____ Nm			Permissible torque at secondary shaft _____ Nm		
<b>Fastening flange</b>	SAE 2-hole	SAE 4-hole	Order code	/ <input type="text"/>		
	VDMA/DIN ISO 2-hole	VDMA/DIN ISO 4-hole				
<b>Shaft end</b>	cylindrical shaft end	involute splining	Order code	/ <input type="text"/>		

<b>Final sequence of the pump stages</b>	<b>Two pump combination</b>	IP <input type="text"/> / <input type="text"/>	<input type="text"/> / <input type="text"/>	-	<input type="text"/> / <input type="text"/>	<input type="text"/>	<input type="text"/>	<input type="text"/>
	<b>Three pump combination</b>	IP <input type="text"/> / <input type="text"/> / <input type="text"/>	<input type="text"/> / <input type="text"/> / <input type="text"/>	-	<input type="text"/> / <input type="text"/> / <input type="text"/>	<input type="text"/>	<input type="text"/>	<input type="text"/>

Voith Turbo H + L Hydraulic GmbH & Co. KG  
Schuckertstr. 15  
71277 Rutesheim, Germany  
Tel. +49 7152 992-3  
Fax +49 7152 992-400  
sales-rut@voith.com  
[www.voithturbo.com/hydraulic-systems](http://www.voithturbo.com/hydraulic-systems)

**VOITH**  
*Engineered reliability.*