

TCN Series Economical Dual Display type, PID Control

Economical dual display type, PID control

■ Features

- Realizes ideal temp. controlling with newly developed PID control algorithm and 100ms high speed sampling
- **Built-in relay output or SSR output selectable**
: Enables to phase control and cycle control with SSR drive output(SSRP function)
- Dramatically increased visibility using wide display part
- Mounting space saving with compact design
: Approx. 38% reduced size compared with existing model(depth-based)

NEW



⚠ Please read "Caution for your safety" in operation manual before using.



■ Ordering information

T CN 4 S - 2 4 R

Control output	R	Relay contact output+SSRP output (AC power) Relay contact output+SSRP output (AC/DC power)
Power supply	2	24VAC 50/60Hz, 24-48VDC
	4	100-240VAC 50/60Hz
Auxiliary output	2	Alarm1+Alarm2 output
Size	S	DIN W48×H48mm
	M	DIN W72×H72mm
	H	DIN W48×H96mm
	L	DIN W96×H96mm
Digit	4	9999(4digit)
Setting type	CN	Dual display type, set by touch switch
Item	T	Temperature controller

■ Specifications

Series		TCN4S	TCN4M	TCN4H	TCN4L
Power supply	AC power	100-240VAC 50/60Hz			
	AC/DC power	24VAC 50/60Hz, 24-48VDC			
Allowable voltage range		90 to 110% of rated voltage			
Power consumption	AC power	Max. 5VA(100-240VAC 50/60Hz)			
	AC/DC power	Max. 5VA(24VAC 50/60Hz), Max. 3W(24-48VDC)			
Display method		7 Segment (PV: red, SV: green), Other display(green, red) LED			
Character size	PV(W×H)	7.0×15.0mm	9.5×20.0mm	7.0×14.6mm	11.0×22.0mm
	SV(W×H)	5.0×9.5mm	7.5×15.0mm	6.0×12.0mm	7.0×14.0mm
Input type	RTD	DPT100Ω, Cu50Ω (allowable line resistance max. 5Ω per a wire)			
	Thermocouple	K(CA), J(IC), L(IC), T(CC), R(PR), S(PR)			
Display accuracy ^{※1}	RTD	• At room temperature (23°C ±5°C): (PV ±0.5% or ±1°C, select the higher one) ±1digit			
	Thermocouple	• Out of room temperature range: (PV ±0.5% or ±2°C, select the higher one) ±1digit			
Control output	Relay	250VAC 3A 1a			
	SSR	12VDC ±2V 20mA Max.			
Alarm output		AL1, AL2 Relay output: 250VAC 1A 1a			
Control method		ON/OFF control, P, PI, PD, PID control			
Hysteresis		1 to 100°C/°F (0.1 to 50.0°C/°F) variable			



※1: ① At room temperature (23°C ±5°C)

- Thermocouple C R, S type, below 200°C: (PV ±0.5% or ±3°C, select the higher one) ±1digit
- Thermocouple R, S type, over 200°C: (PV ±0.5% or ±2°C, select the higher one) ±1digit
- Thermocouple L(IC) type, RTD Cu50Ω: (PV ±0.5% or ±2°C, select the higher one) ±1digit
- ② Out of room temperature range
 - Thermocouple R, S type, below 200°C: (PV ±1.0% or ±6°C, select the higher one) ±1digit
 - Thermocouple R, S type, over 200°C: (PV ±0.5% or ±5°C, select the higher one) ±1digit
 - RTD Cu50Ω: (PV ±0.5% or ±3°C, select the higher one) ±1digit

(A)	Photo electric sensor
(B)	Fiber optic sensor
(C)	Door/Area sensor
(D)	Proximity sensor
(E)	Pressure sensor
(F)	Rotary encoder
(G)	Connector/Socket
(H)	Temp. controller
(I)	SSR/ Power controller
(J)	Counter
(K)	Timer
(L)	Panel meter
(M)	Tacho/ Speed/ Pulse meter
(N)	Display unit
(O)	Sensor controller
(P)	Switching mode power supply
(Q)	Stepper motor& Driver&Controller
(R)	Graphic/ Logic panel
(S)	Field network device
(T)	Software
(U)	Other

TCN Series

Specifications

Series	TCN4S	TCN4M	TCN4H	TCN4L
Proportional band (P)	0.1 to 999.9°C/°F			
Integral time (I)	0 to 9999 sec.			
Derivative time (D)	0 to 9999 sec.			
Control period (T)	0.5 to 120.0 sec.			
Manual reset	0.0 to 100.0%			
Sampling period	100ms			
Dielectric strength	AC Power	2,000VAC 50/60Hz 1min.(between input terminal and power terminal)		
	AC/DC power	1,000VAC 50/60Hz 1min.(between input terminal and power terminal)		
Vibration	0.75mm amplitude at frequency of 5 to 55Hz in each of X, Y, Z directions for 2 hours			
Relay life cycle	Mechanical	OUT: Over 5,000,000 times, AL1/2: Over 5,000,000 times		
	Electrical	OUT: Over 200,000 times(250VAC 3A resistive load) AL1/2: Over 300,000 times(250VAC 1A resistive load)		
Insulation resistance	Min. 100MΩ(at 500VDC megger)			
Noise resistance	±2kV R-phase, S-phase the square wave noise (pulse width: 1us) by the noise simulator			
Memory retention	Approx. 10 years (when using non-volatile semiconductor memory type)			
Environment	Ambient temperature	-10 to 50°C, storage: -20 to 60°C		
	Ambient humidity	35 to 85%RH, storage: 35 to 85%RH		
Insulation type	Double insulation or reinforced insulation (mark:  , Dielectric strength between the measuring input part and the power part: AC power 2kV, AC/DC Power 1kV)			
Approval	 			
Weight ^{※2}	Approx. 147g (Approx. 100g)	Approx. 203g (Approx. 133g)	Approx. 194g (Approx. 124g)	Approx. 275g (Approx. 179g)

※2: The weight is with packaging and the weight in parentheses is only unit weight.
 ※Environment resistance is rated at no freezing or condensation.

Connections

※TCN4 Series has selectable control output; Relay output, and SSRP output. AC/DC voltage type has Relay output and SSR output and it is selectable.

TCN4S

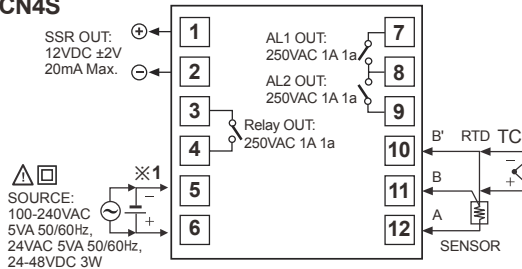

TCN4M

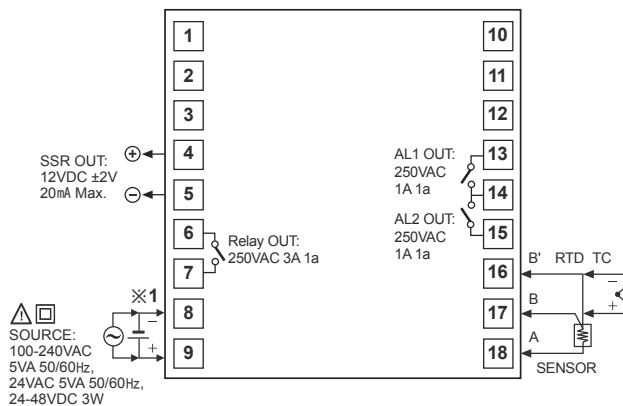

※1: Power supply
 • AC power: 100-240VAC 5VA 50/60Hz
 • AC/DC power: 24VAC 5VA 50/60Hz, 24-48VDC 3W

TCN4H/L

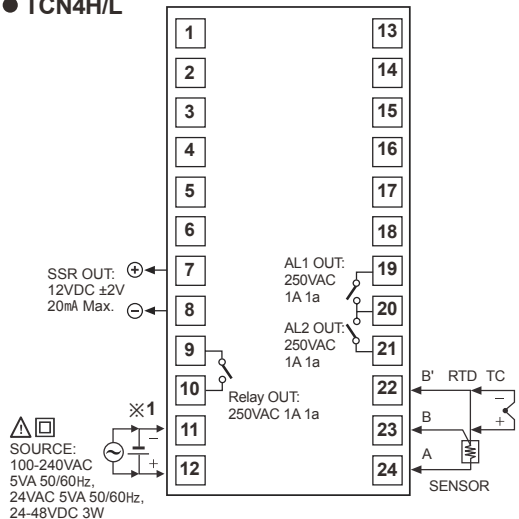

Economical Dual Display type, PID Control

■ Dimensions

(unit: mm)

● TCN4S

<Bracket>

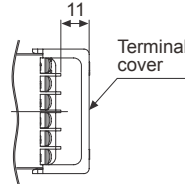
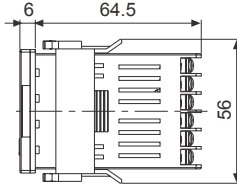
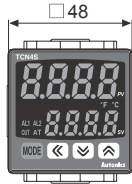
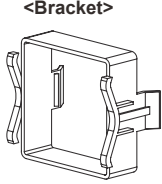

●Panel cut-out

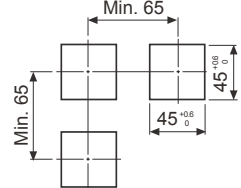

● TCN4M

<Bracket>

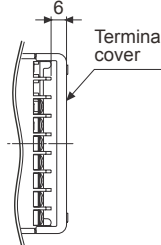
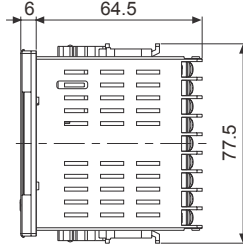
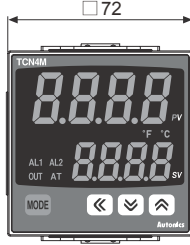
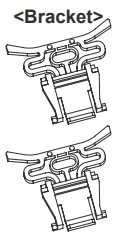

●Panel cut-out

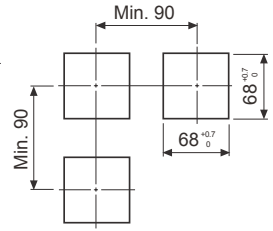

● TCN4H

<Bracket>

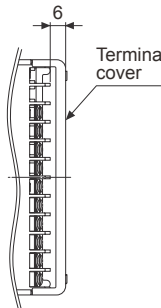
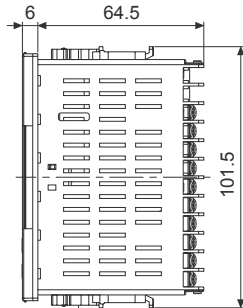
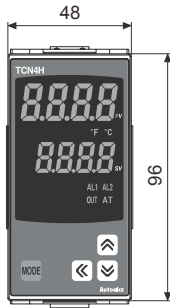
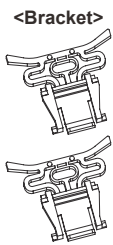

●Panel cut-out

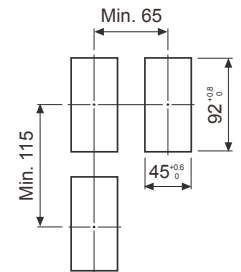

● TCN4L

<Bracket>

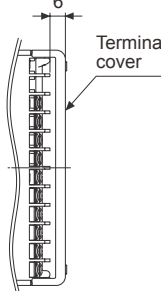
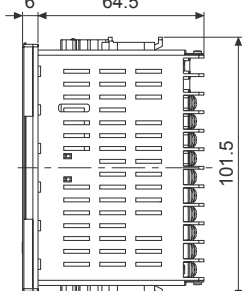
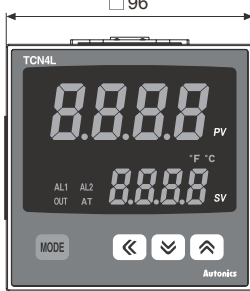
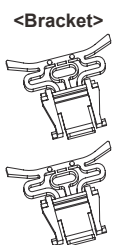

●Panel cut-out

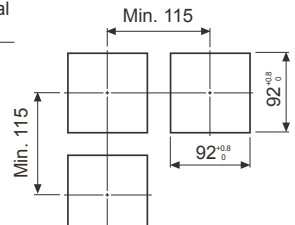

● Terminal cover(sold separately)

● RSA-COVER (48×48mm)

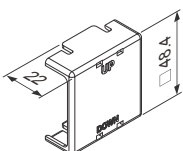

● RMA-COVER (72×72mm)

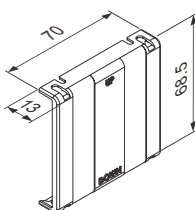

● RHA-COVER (48×96mm)

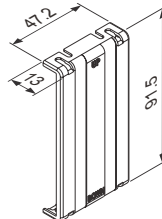

● RLA-COVER (96×96mm)

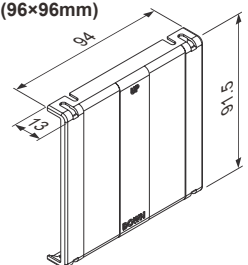

(A) Photo electric sensor

(B) Fiber optic sensor

(C) Door/Area sensor

(D) Proximity sensor

(E) Pressure sensor

(F) Rotary encoder

(G) Connector/Socket

(H) Temp. controller

(I) SSR/Power controller

(J) Counter

(K) Timer

(L) Panel meter

(M) Tacho/Speed/Pulse meter

(N) Display unit

(O) Sensor controller

(P) Switching mode power supply

(Q) Stepper motor& Driver&Controller

(R) Graphic/Logic panel

(S) Field network device

(T) Software

(U) Other

TCN Series

Product mounting

TCN4S(48×48mm) Series

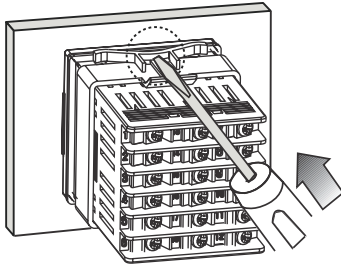

※Mount the product on the panel, fasten bracket by pushing with tools as shown above.

Other Series

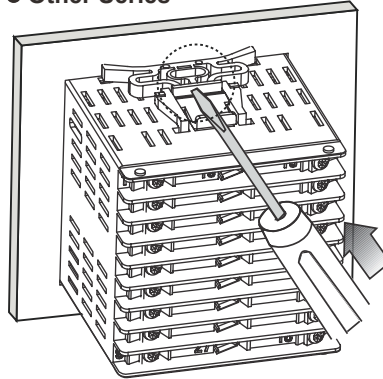

Parts description

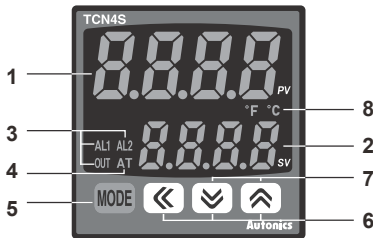

1. Present temperature (PV) display (red)

- RUN mode: Present temperature (PV) display.
- Parameter setting mode: Parameter display.

2. Set temperature (SV) display (green)

- RUN mode: Set temperature (SV) display.
- Parameter setting mode: Parameter setting value display.

3. Control/Alarm output display lamp

- AL1/AL2: It turns ON when the alarm output is ON.
- OUT: It turns ON when the control output is ON.

※During SSR drive control output type in CYCLE/PHASE control, this lamp turns ON when MV is over 3.0%.

4. **Auto tuning lamp:** AT lamp flashes by every 1 sec during operating auto tuning.

5. **MODE key:** Used when entering into parameter setting group, returning to RUN mode, moving parameter, and saving setting values.

6. **Adjustment:** Used when entering into set value change mode, digit moving and digit up/down.

7. **Digital input key:** Press \checkmark + \boxtimes keys for 3 sec. to operate the set function(RUN/STOP, alarm output reset, auto tuning) in digital input key [d1 - d].

8. **Temperature unit(°C/°F) indicator:** It shows current temperature unit.

SV setting

You can set the temperature to control with **MODE**, \leftarrow , \checkmark , \boxtimes keys.

Set range is within SV lower limit value [L - 5.0] to SV higher limit value [H - 5.0].

Ex) In case of changing set temperature from 210°C to 250°C

1 Press any key among **MODE**, \leftarrow , \checkmark , \boxtimes key in RUN mode, the right digit at SV display flashes and it enters to SV setting.

2 Press \leftarrow key to move the desired digit. ($10^0 \rightarrow 10^1 \rightarrow 10^2 \rightarrow 10^3 \rightarrow 10^0$)

3 Press \checkmark or \boxtimes key to move the desired number (1 \rightarrow 5).

4 Press **MODE** key to save the value and it controls with this set value. (even though there is no key input for over 3 sec., it saves automatically.)

Economical Dual Display type, PID Control

Parameter setting group

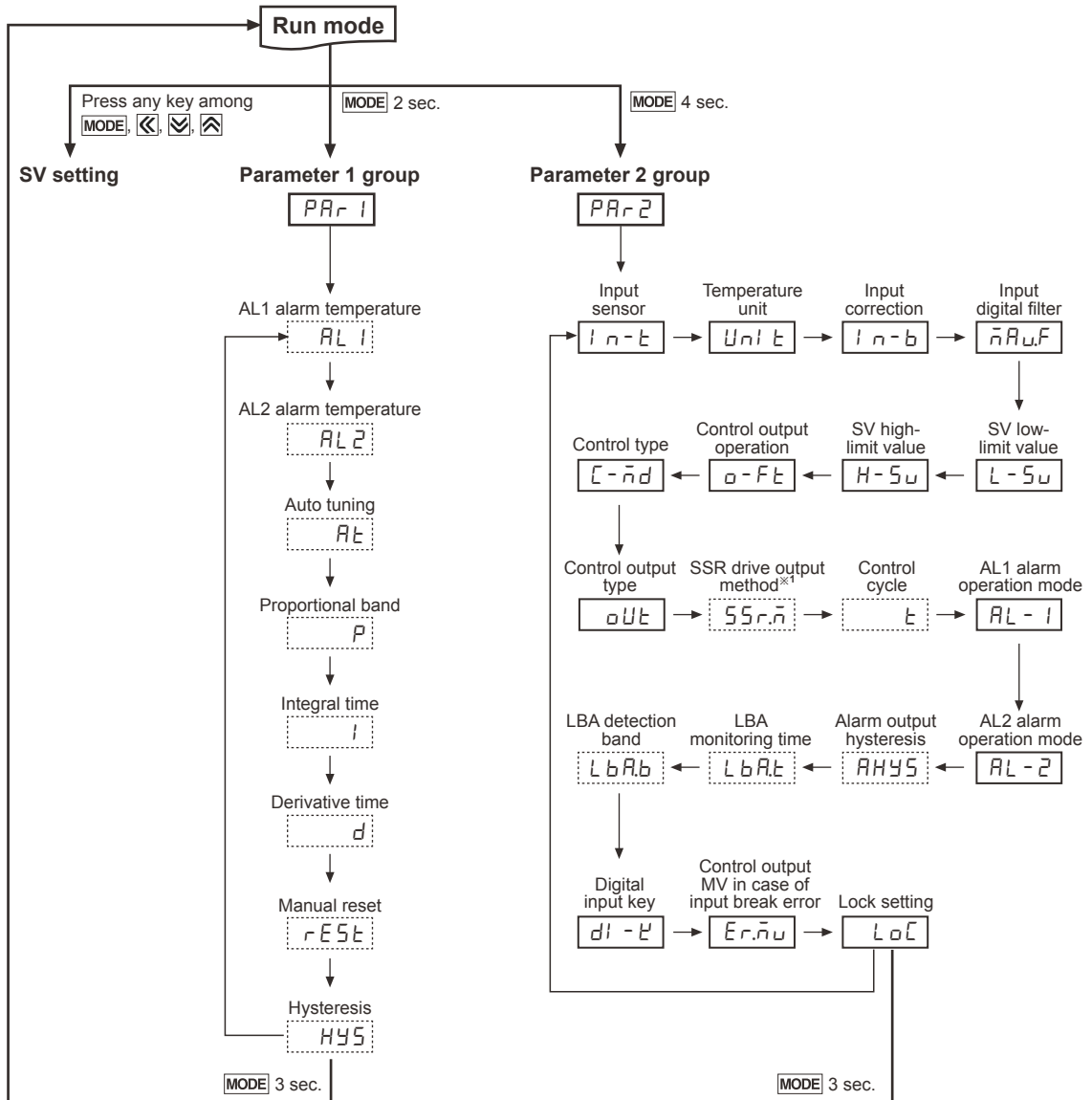

(A)	Photo electric sensor
(B)	Fiber optic sensor
(C)	Door/Area sensor
(D)	Proximity sensor
(E)	Pressure sensor
(F)	Rotary encoder
(G)	Connector/Socket
(H)	Temp. controller
(I)	SSR/Power controller
(J)	Counter
(K)	Timer
(L)	Panel meter
(M)	Tacho/Speed/Pulse meter
(N)	Display unit
(O)	Sensor controller
(P)	Switching mode power supply
(Q)	Stepper motor& Driver&Controller
(R)	Graphic/Logic panel
(S)	Field network device
(T)	Software
(U)	Other

- ※ Press **MODE** key over 3 sec in any setting group, it saves the set value and returns to RUN mode. (Press **MODE** key once in SV setting, it returns to RUN mode).
- ※ If no key entered for 30 sec., it returns to RUN mode automatically and the set value of parameter is not be saved.
- ※ Press **MODE** key again within 1 sec. after returning to RUN mode, it advances of the first parameter of previous setting group.
- ※ Press **MODE** key to move next parameter.
- ※ { } This parameter might not be displayed depending on other parameter settings.
- ※ Set parameter as 'Parameter 2group → Parameter 1group → Setting of set value' order considering parameter relation of each setting group.
- ※ 1: It is not displayed for AC/DC power model (TCN4□-22R).

Parameter 1 group

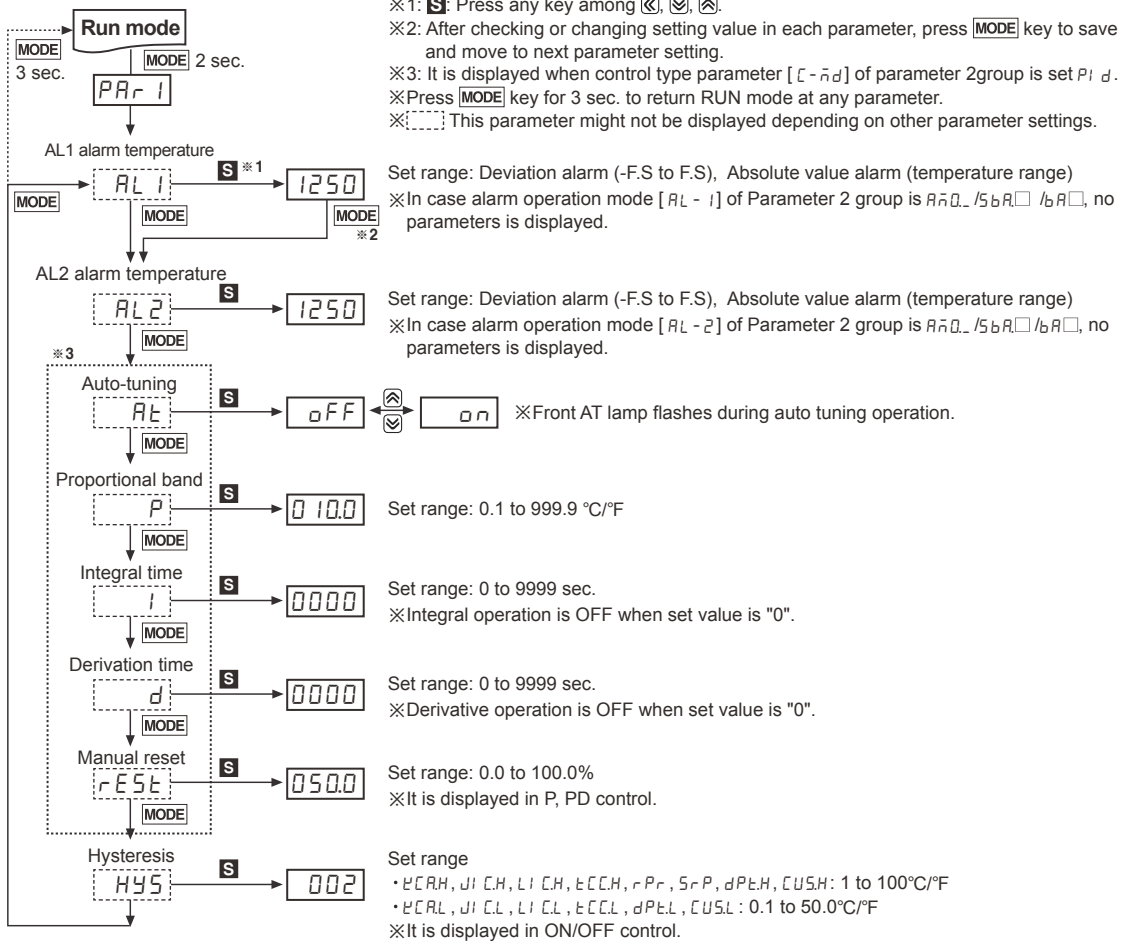

Parameter 2 group

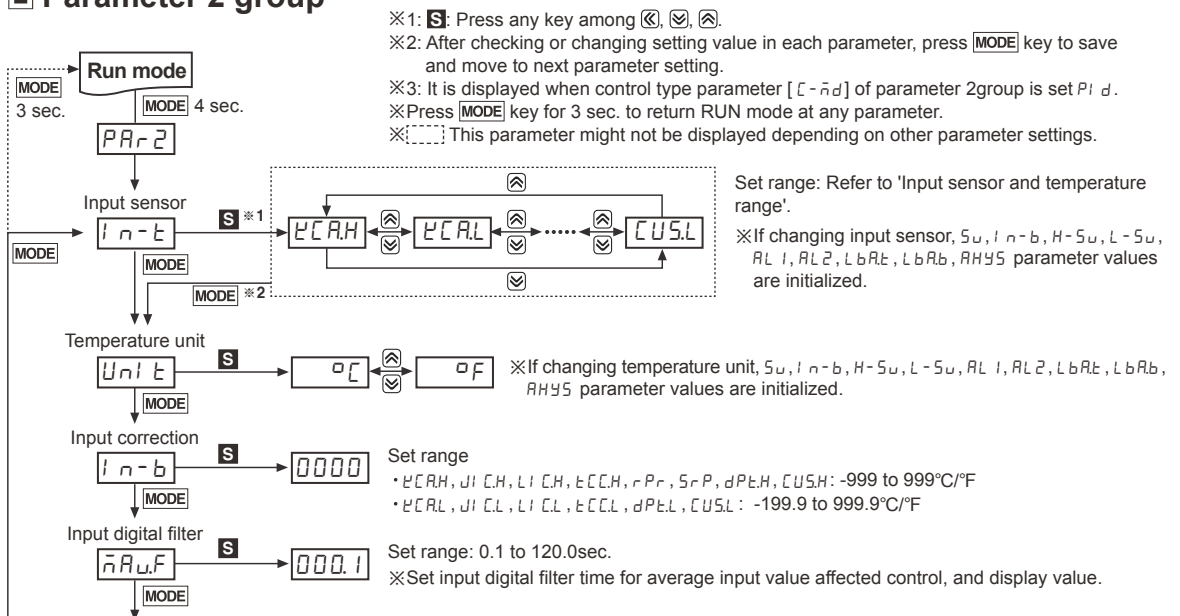

Economical Dual Display type, PID Control

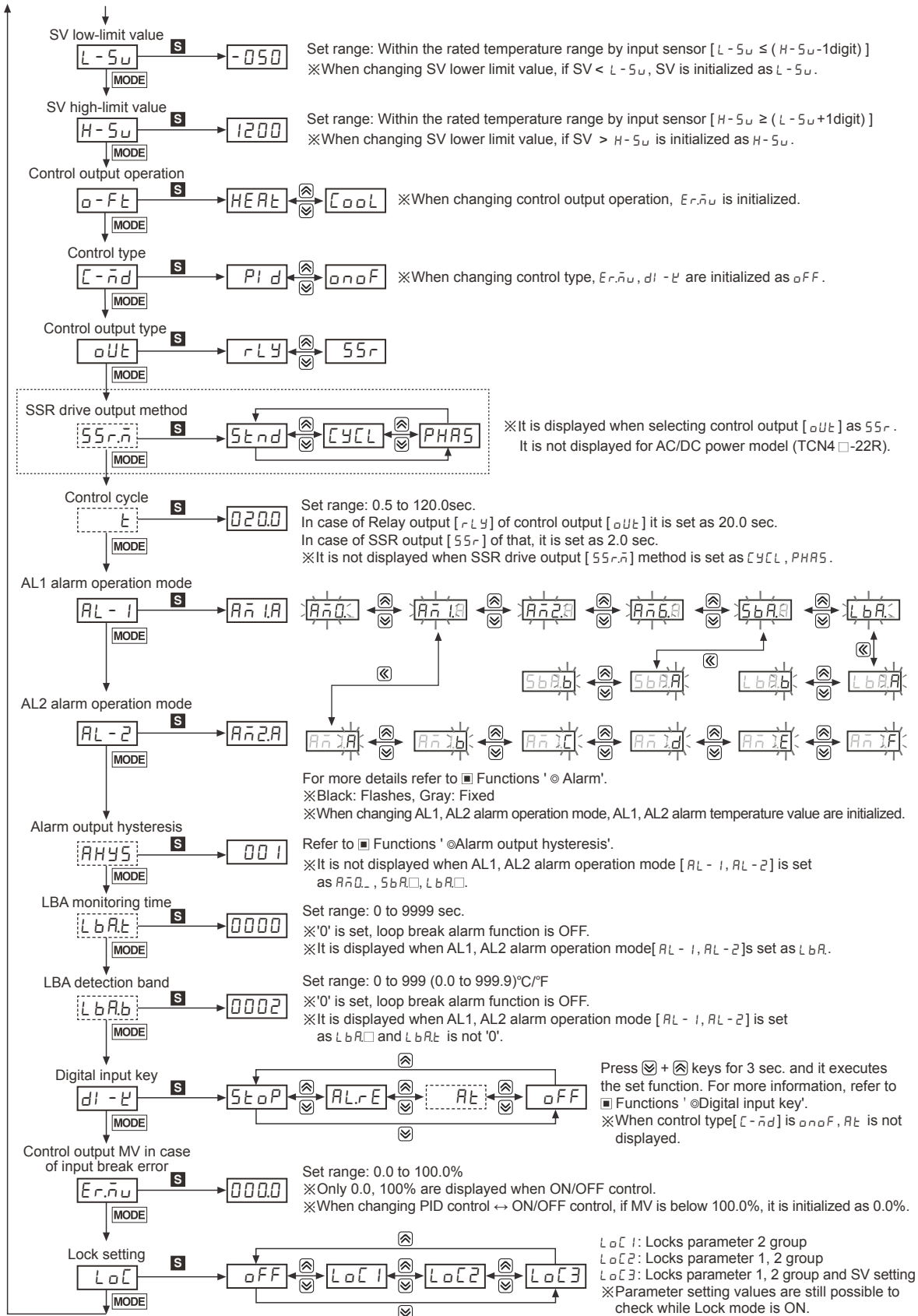

(A)	Photo electric sensor
(B)	Fiber optic sensor
(C)	Door/Area sensor
(D)	Proximity sensor
(E)	Pressure sensor
(F)	Rotary encoder
(G)	Connector/Socket
(H)	Temp. controller
(I)	SSR/Power controller
(J)	Counter
(K)	Timer
(L)	Panel meter
(M)	Tacho/Speed/Pulse meter
(N)	Display unit
(O)	Sensor controller
(P)	Switching mode power supply
(Q)	Stepper motor& Driver&Controller
(R)	Graphic/Logic panel
(S)	Field network device
(T)	Software
(U)	Other

TCN Series

Input type and range

Input sensor		Display	Temperature range (°C)	Temperature range (°F)
Thermocouple	K(CA)	℄CRAH	-50 to 1200	-58 to 2192
		℄CRL	-50.0 to 999.9	-58.0 to 999.9
	J(IC)	J1 CH	-30 to 800	-22 to 1472
		J1 CL	-30.0 to 800.0	-22.0 to 999.9
	L(IC)	L1 CH	-40 to 800	-40 to 1472
		L1 CL	-40.0 to 800.0	-40 to 999.9
	T(CC)	℄CCH	-50 to 400	-58 to 752
		℄CCL	-50.0 to 400.0	-58.0 to 752.0
R(PR)	r Pr	0 to 1700	32 to 3092	
S(PR)	S Pr	0 to 1700	32 to 3092	
RTD	DPT100Ω	d℄tH	-100 to 400	-148 to 752
		dP℄L	-100.0 to 400.0	-148.0 to 752.0
	Cu50Ω	℄U5H	-50 to 200	-58 to 392
		℄U5L	-50.0 to 200.0	-58.0 to 392.0

Factory default

Parameter 1 group

Parameter		Factory default
SV setting	—	0
AL1 alarm temperature	AL1	1250
AL2 alarm temperature	AL2	1250
Auto tuning	At	OFF
Proportional band	P	0.100
Integral time	I	0000
Derivative time	d	0000
Manual reset	RESt	0500
Hysteresis	HYS	002

Parameter 2 group

Parameter		Factory default
Input sensor	ln-t	℄CRAH
Temperature unit	Unit	°C
Input correction	ln-b	0000
Input digital filter	ñRUF	000.1
SV low-limit value	L-Su	-050
SV high-limit value	H-Su	1200
Control output operation	o-Ft	HERt
Control type	C-ñd	PId
Control output	oUt	rLY
SSR drive output method	SSr.ñ	Stnd
Control cycle	t	0200
AL1 alarm operation mode	AL-1	Rñ1.R
AL2 alarm operation mode	AL-2	Rñ2.R
Alarm output hysteresis	RHYS	00.1
LBA monitoring time	LbRt	0000
LBA detection band	LbRb	0002
Digital input key	di-t	StoP
Control output MV in case of input break error	Er.ñu	0000
Lock setting	LoC	OFF

Economical Dual Display type, PID Control

■ Functions

◎ Alarm [$AL - 1 / AL - 2$]

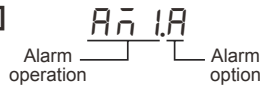

There are two alarms which operate individually. You can set combined alarm operation and alarm option. Use digital input key(set as $AL - E$) or turn OFF power and re-start this unit to release alarm operation.

● Alarm operation

Mode	Name	Alarm operation	Description
$Rn 0$	—	—	No alarm output
$Rn 1$	Deviation high-limit alarm		If deviation between PV and SV as high-limit is higher than set value of deviation temperature, the alarm output will be ON.
$Rn 2$	Deviation low-limit alarm		If deviation between PV and SV as low-limit is higher than set value of deviation temperature, the alarm output will be ON.
$Rn 3$	Deviation high/low-limit alarm		If deviation between PV and SV as high/low-limit is higher than set value of deviation temperature, the alarm output will be ON.
$Rn 4$	Deviation high/low-limit reserve alarm		If deviation between PV and SV as high/low-limit is higher than set value of deviation temperature, the alarm output will be OFF.
$Rn 5$	Absolute value high limit alarm		If PV is higher than the absolute value, the output will be ON.
$Rn 6$	Absolute value low limit alarm		If PV is lower than the absolute value, the output will be ON.
$5bR$	Sensor break Alarm	—	It will be ON when it detects sensor disconnection.
LbR	Loop break Alarm	—	It will be ON when it detects loop break.

※ H: Alarm output hysteresis [$RH45$]

● Alarm option

Mode	Name	Description
$Rn \square A$	Standard alarm	If it is an alarm condition, alarm output is ON. If it is a clear alarm condition, alarm output is OFF.
$Rn \square b$	Alarm latch	If it is an alarm condition, alarm output is ON and maintains ON status.
$Rn \square C$	Standby sequence1	First alarm condition is ignored and from second alarm condition, standard alarm operates. When power is supplied and it is an alarm condition, this first alarm condition is ignored and from the second alarm condition, standard alarm operates.
$Rn \square d$	Alarm latch and standby sequence1	If it is an alarm condition, it operates both alarm latch and standby sequence. When power is supplied and it is an alarm condition, this first alarm condition is ignored and from the second alarm condition, alarm latch operates.
$Rn \square E$	Standby sequence2	First alarm condition is ignored and from second alarm condition, standard alarm operates. When re-applied standby sequence and if it is alarm condition, alarm output does not turn ON. After clearing alarm condition, standard alarm operates.
$Rn \square F$	Alarm latch and standby sequence2	Basic operation is same as alarm latch and standby sequence1. It operates not only by power ON/OFF, but also alarm setting value, or alarm option changing. When re-applied standby sequence and if it is alarm condition, alarm output does not turn ON. After clearing alarm condition, alarm latch operates.

※ Condition of re-applied standby sequence for standby sequence 1, alarm latch and standby sequence 1: Power ON
 Condition of re-applied standby sequence for standby sequence 2, alarm latch and standby sequence 2: Power ON, changing set temperature, alarm temperature[$AL 1, AL 2$] or alarm operation[$AL - 1, AL - 2$], switching STOP mode to RUN mode.

◎ Sensor break alarm

The function that alarm output will be ON when sensor is not connected or when sensor's disconnection is detected during temperature controlling. You can check whether the sensor is connected with buzzer or other units using alarm output contact. It is selectable between standard alarm [$5bR$], or alarm latch [$5bRb$].

(A)	Photo electric sensor
(B)	Fiber optic sensor
(C)	Door/Area sensor
(D)	Proximity sensor
(E)	Pressure sensor
(F)	Rotary encoder
(G)	Connector/Socket
(H)	Temp. controller
(I)	SSR/Power controller
(J)	Counter
(K)	Timer
(L)	Panel meter
(M)	Tacho/Speed/Pulse meter
(N)	Display unit
(O)	Sensor controller
(P)	Switching mode power supply
(Q)	Stepper motor& Driver&Controller
(R)	Graphic/Logic panel
(S)	Field network device
(T)	Software
(U)	Other

◎ Loop break alarm(LBA)

It checks control loop and outputs alarm by temperature change of the subject. For heating control(cooling control), when control output MV is 100%(0% for cooling control) and PV is not increased over than LBA detection band [L b R L] during LBA monitoring time [L b R L], or when control output MV is 0%(100% for cooling control) and PV is not decreased below than LBA detection band [L b R L] during LBA monitoring time [L b R L], alarm output turns ON.

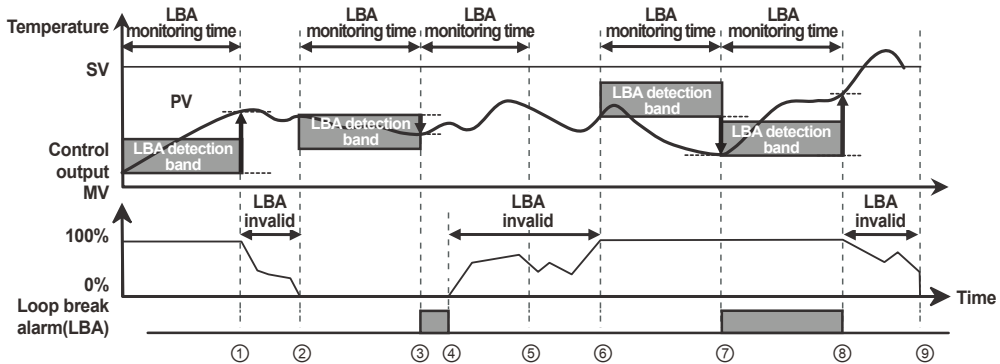

Start control to ①	When control output MV is 0% and PV is not decreased below than LBA detection band [L b R L] during LBA monitoring time [L b R L]
① to ②	The status of changing control output MV (LBA monitoring time is reset.)
② to ③	When control output MV is 0% and PV is not decreased below than LBA detection band [L b R L] during LBA monitoring time [L b R L] loop break alarm (LBA) turns ON after LBA monitoring time.
③ to ④	Control output MV is 0% and loop break alarm (LBA) turns and maintains ON.
④ to ⑥	The status of changing control output MV (LBA monitoring time is reset.)
⑥ to ⑦	When control output MV is 100% and PV is not increased over than LBA detection band [L b R L] during LBA monitoring time [L b R L], loop break alarm (LBA) turns ON after LBA monitoring time.
⑦ to ⑧	When control output MV is 100% and PV is increased over than LBA detection band [L b R L] during LBA monitoring time [L b R L] loop break alarm (LBA) turns OFF after LBA monitoring time.
⑧ to ⑨	The status of changing control output MV (LBA monitoring time is reset.)

※When executing auto-tuning, LBA detection band[L b R L] and LBA monitoring time are automatically set based on auto tuning value. When alarm operation mode [AL - 1, AL - 2] is set as loop break alarm(LBA)[L b R □], LBA detection band [L b R L] and LBA monitoring time [L b R L] parameter is displayed.

◎ SSR drive output function(SSRP function) [55r.ñ]

- Realizing high accuracy and cost effective temperature control with both current output (4-20mA) and linear output(cycle control and phase control)
- SSRP output is selectable one of standard ON/OFF control, cycle control, phase control by utilizing standard SSR drive voltage output.
- Select one of standard ON/OFF control [5E n d], cycle control[LYCL], phase control[PHAS] at 55r.ñ parameter of setting 2 group. For cycle control, connect zero cross turn-on SSR (random turn-on SSR is also available). For phase control, connect random turn-on SSR.

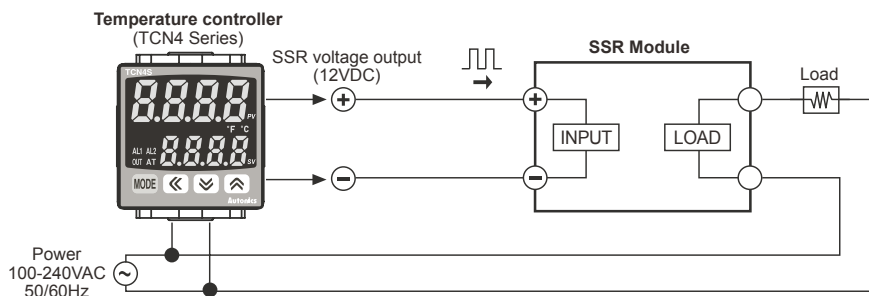

※When selecting phase or cycle control mode, the power supply for load and temperature controller must be the same.

※In case of selecting PID control type and phase [PHAS] / cycle [LYCL] control output modes, control cycle [L] is not allowed to set.

※For AC/DC power model (TCN4 □ -22R), this parameter is not displayed and it is available only standard control by relay or SSR.

Economical Dual Display type, PID Control

● Standard ON/OFF control mode [5tnd]

A mode to control the load in the same way as Relay output type.
(ON: output level 100%, OFF: output level 0%)

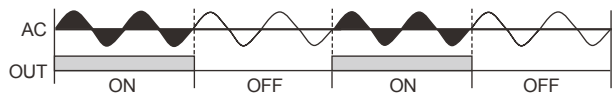

● Cycle control mode [CYCL]

A mode to control the load by repeating output ON / OFF according to the rate of output within setting cycle.
Having improved ON / OFF noise feature by Zero Cross type.

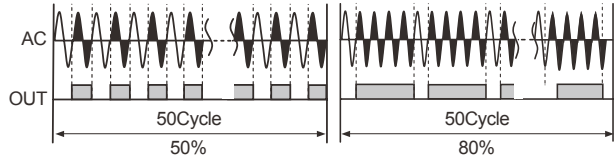

● Phase control mode [PHAS]

A mode to control the load by controlling the phase within AC half cycle. Serial control is available.
RANDOM Turn-on type SSR must be used for this mode.

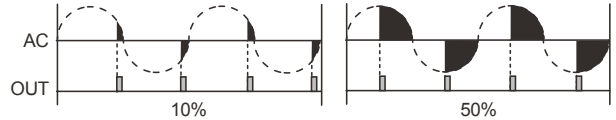

◎ Auto tuning [At]

- Auto tuning measures the control subject's thermal characteristics and thermal response rate, and then determines the necessary PID time constant. (When control type [C-nd] is set as PID, it is displayed.)
- If error [PEN] occurs during auto tuning, it stops this operation automatically.
- To stop auto tuning, change the set as OFF. (It maintains P, I, D values of before auto tuning.)

◎ Input correction [In-b]

Controller itself does not have errors but there may be error by external input temperature sensor.

Ex) If actual temperature is 80°C but controller displays 78°C, set input correction value [In-b] as 002 and controller displays 80°C.

※As the result of input correction, if current temperature value (PV) is over each temperature range of input sensor, it displays HHHH or LLLL.

◎ Input digital filter [nRUF]

If current temperature(PV) is fluctuating repeatedly by rapid change of input signal, it reflects to MV and stable control is impossible. Therefore, digital filter function stabilizes current temperature value.

- For example, set input digital filter value as 0.4 sec, and it applies digital filter to input values during 0.4 sec and displays this values. Current temperature may be different by actual input value.

◎ SV High/Low limit [L-SV / H-SV]

- It sets SV high/low limit range of using temperature within temperature range for each sensor, user can set/change set temperature(SV) within SV high limit [H-SV] to SV low limit [L-SV]. (※ L-SV > H-SV cannot be set.)
- When changing input type [In-t], SV high limit [H-SV] and SV low limit [L-SV] of using temperature will be initialized as max./min.value of sensor temperature range automatically.

◎ Hysteresis [HYS]

- In case of ON/OFF control, set between ON and OFF intervals as hysteresis. (When control type [C-nd] is set as ONOFF, it is displayed.)
- If hysteresis is too small, it may cause control output hunting (take off, chattering) by external noise, etc.

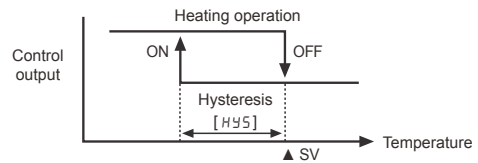

◎ Manual reset [rESt]

When selecting P/PD control mode, certain temperature difference exists even after PV reaches stable status because heater's rising and falling time is inconsistent due to thermal characteristics of controlled objects, such as heat capacity, heater capacity. This temperature difference is called offset and manual reset [rESt] function is to set/correct offset.

- When PV and SV are equal, reset value is 50.0%. After control is stable, PV is lower than SV, reset value is over 50.0% or PV is higher than SV, reset value is below 50.0%.
- Manual reset [rESt] by control result

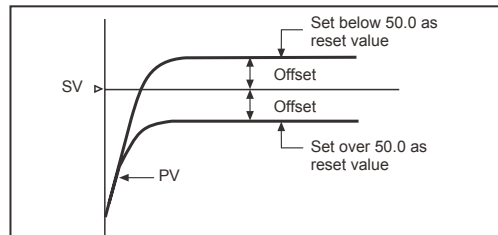

※Manual reset function is applicable only to P / PD control mode.

◎ Temperature unit selection [Unit]

- A function to select display temperature unit.
- Unit display lamp will be ON when converting temperature unit.

(A)	Photo electric sensor
(B)	Fiber optic sensor
(C)	Door/Area sensor
(D)	Proximity sensor
(E)	Pressure sensor
(F)	Rotary encoder
(G)	Connector/Socket
(H)	Temp. controller
(I)	SSR/Power controller
(J)	Counter
(K)	Timer
(L)	Panel meter
(M)	Tacho/Speed/Pulse meter
(N)	Display unit
(O)	Sensor controller
(P)	Switching mode power supply
(Q)	Stepper motor& Driver&Controller
(R)	Graphic/Logic panel
(S)	Field network device
(T)	Software
(U)	Other

TCN Series

◎ Cool / Heat function [\square -F \square]

Generally there are two ways to control temperature, one (heat-function) is to heat when PV is getting down(heater). The other(cool-function) is to cool when PV is getting higher (freezer).

These functions are operating oppositely when it is ON/OFF control or proportional control. But in this case PID time constant will be different due to PID time constant will be decided according to control system when it is PID control.

- Cool-function [\square 00L] and heat-function [HERR] must be set correctly according to the application, if set as opposite function, it may cause a fire. (If set cool-function [\square 00L] at heater, it will be maintained ON and it may cause a fire.)
- Avoid changing heat-function to cool-function or cool-function to heat-function when the unit is operating.
- It is impossible to operate both function at once in this unit. Therefore, only one function should be selected only.

◎ Control method selection [\square - \bar{n} d]

It is selectable PID, ON/OFF control.

- In case of ON/OFF [\square 00F] mode, Hysteresis [HYS] parameter is displayed.
- In case of PID [PId] mode, Proportional band [P], Integral time [I], and Derivative time [\square] parameters are displayed.

◎ Digital input key(\square + \square 3sec.) [dI - \square]

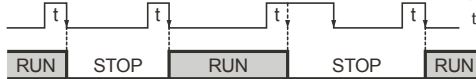
Parameter		Operation
OFF	\square FF	It does not use digital input key function.
RUN/STOP	S \square 0P	It is available to pause on control output and auxiliary output (except loop break alarm, sensor break alarm) except control output operates normally as set. Press digital input key for 3sec. to re-start the operation. 
Clear alarm output function	R \square rE	It is available to clear alarm output by force. (It is only when alarm option is alarm latch, standby sequence.) Clear alarm is able to only for out of alarm operation range. Alarm operates normally right after clear alarm.
Auto tuning	R \square	Auto tuning function, it is same as auto tuning function [R \square] of parameter 1group. (You can execute auto tuning from parameter 1group, and finish it by digital input key.) ※When control type [\square - \bar{n} d] is set as PId, R \square is displayed. When it is set as \square 00F, digital input key [dI - \square] is changed as \square FF.

◎ Lock setting [L \square C]

A function to prevent changing SV and parameters of each setting group. Parameter setting values are still possible to check while Lock mode is ON.

Display	Description
\square FF	Lock off
L \square C1	Lock parameter group 2
L \square C2	Lock parameter group 1, 2
L \square C3	Lock parameter group 1, 2, SV setting

◎ Control output type selection [\square U \square]

It is selectable output type ; relay output [rLY], SSR drive output [SSR].

◎ Alarm output hysteresis [AHYS]

It displays alarm output ON and OFF interval and hysteresis is applied to both AL1 OUT and AL2 OUT.

• \square ERRH, dI CH, LI CH, \square CC \square , rPr, SP \square , dPEH, CUS \square : 1 to 100

• \square ERRL, dI CL, LI CL, \square CC \square , dPEL, CUSL : 0.1 to 50.0

Ex) AL1 alarm operation [RL - I]: R \bar{n} 3R,
 AL1 alarm operation [RL I]: 10°C,
 Alarm output hysteresis [AHYS]: 4

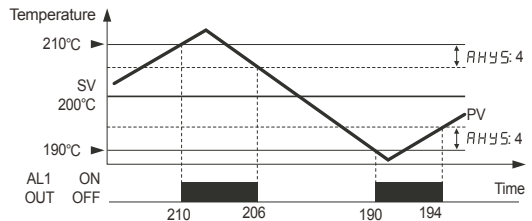

◎ Control output MV [Er. \bar{n} U] when input sensor line is broken [\square PE \bar{n}] / setting error [Er \square U] occur

When input sensor line is broken or setting value error occurs, this function is to set control output. You can set ON/OFF setting for ON/OFF control, MV setting for PID control.

◎ Error

Display	Description	Troubleshooting
\square PE \bar{n}	Flashes if input sensor is disconnected or sensor is not connected.	Check input sensor state.
HHHH	Flashes if measured sensor input is higher than temperature range.	When input is within the rated temperature range, this display disappears.
LLLL	Flashes if measured sensor input is lower than temperature range.	

Economical Dual Display type, PID Control

◎ Output connections

See H-139 page for output.

● Application of relay output type

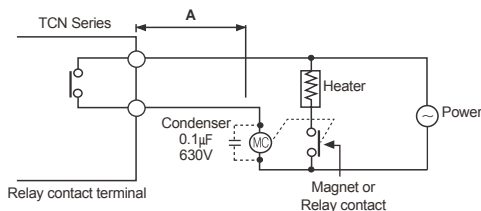

Keep **A** length as long as possible when wiring the temperature controller and the load. If wire length of **A** is short, counter electromotive force which occurs from a coil of magnet switch & power relay may flow in power line of the unit, and it may cause malfunction.

If wire length of **A** is short, please connect mylar condensers 104(630V) on the both ends of "MC" (magnet coil) to protect electromotive force.

● Application of SSR drive output method

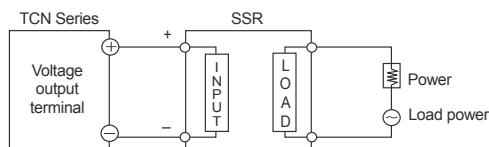

- ※SSR should be selected by the capacity of load, otherwise, it may short-circuit and result in a fire. Indirect heated should be used with SSR for efficient working.
- ※Please use a cooling plate or it may cause the capacity deterioration, breakdown of SSR for a long usage.
- ※Refer to the H-50 page for phase/cycle control connections.

■ Proper usage

◎ Simple "error" diagnosis

● When the load (Heater etc) is not operated

Please check operation of the OUT lamp located in front panel of the unit.

If the OUT lamp does not operate, please check the parameter of all programmed mode.

If lamp is operating, please check the output(Relay, SSR drive voltage) after separating output line from the unit.



● When it displays $\square PE n$ during operation

This is a warning that external sensor is open. Please turn off the power and check the wire state of the sensor. If sensor is not open disconnect sensor line from the unit and short the input +, - terminal. Turn on the power of the unit and check the controller displays room temperature.

If this unit cannot display room temperature, this unit is broken. Please remove this unit and contact our service center. (When the input mode is thermocouple, it is available to display room temperature.)

◎ Caution for using

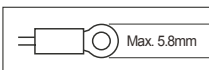
- The connection wire of this unit should be separated from the power line and high voltage line in order to prevent from inductive noise.
- For crimp terminal, select following shaped terminal (M3)



- Please install power switch or circuit-breaker in order to cut power supply off.
- The switch or circuit-breaker should be installed near by users.
- This unit is designed for temperature controlling only. Do not apply this unit as a voltage meter or a current meter.
- In case of using RTD sensor, 3-wire type must be used. If you need to extend the line, 3-wires must be used with the same thickness as the line. It might cause temperature difference if the resistance of line is different.
- In case of making power line and input signal line close, line filter for noise protection should be installed at power line and input signal line should be shielded.
- Keep away from the high frequency instruments.(High frequency welding machine & sewing machine, big capacitive SCR controller)
- When supplying measured input, if HHHH or LLLL is displayed, measured input may have problem. Turn off the power and check the line.
- Installation environment
 - It shall be used indoor.
 - Altitude Max. 2000m.
 - Pollution Degree 2
 - Installation Category II.

(A)	Photo electric sensor
(B)	Fiber optic sensor
(C)	Door/Area sensor
(D)	Proximity sensor
(E)	Pressure sensor
(F)	Rotary encoder
(G)	Connector/Socket
(H)	Temp. controller
(I)	SSR/ Power controller
(J)	Counter
(K)	Timer
(L)	Panel meter
(M)	Tacho/ Speed/ Pulse meter
(N)	Display unit
(O)	Sensor controller
(P)	Switching mode power supply
(Q)	Stepper motor& Driver&Controller
(R)	Graphic/ Logic panel
(S)	Field network device
(T)	Software
(U)	Other