

Termination Board

HiCTB16-YC3-RRB-KS-CC-AI16-Y2

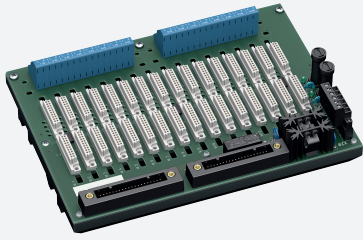

- System board for Yokogawa CENTUM VP
- For 16-channel AI card AAV141
- For 16 modules
- Recommended module: HiC2025(A) (AI)
- 24 V DC supply
- Hazardous area: spring terminals, blue
- Non-hazardous area: Yokogawa system connector, 40-pin



Function

The function of the termination board and the connector pin assignment is exactly fitted to the requirements of the Yokogawa Centum VP system. The signal is output to the process control system via the system connector. Information about a missing supply voltage of the isolators is available for the system as a volt-free contact. Wiring faults from the field side will be reported via the same relay contact, if this function is supported by the isolators. The termination board has a robust plastic housing. The termination board is mounted in the switch cabinet on a 35 mm DIN mounting rail according to EN 60175.

Connection

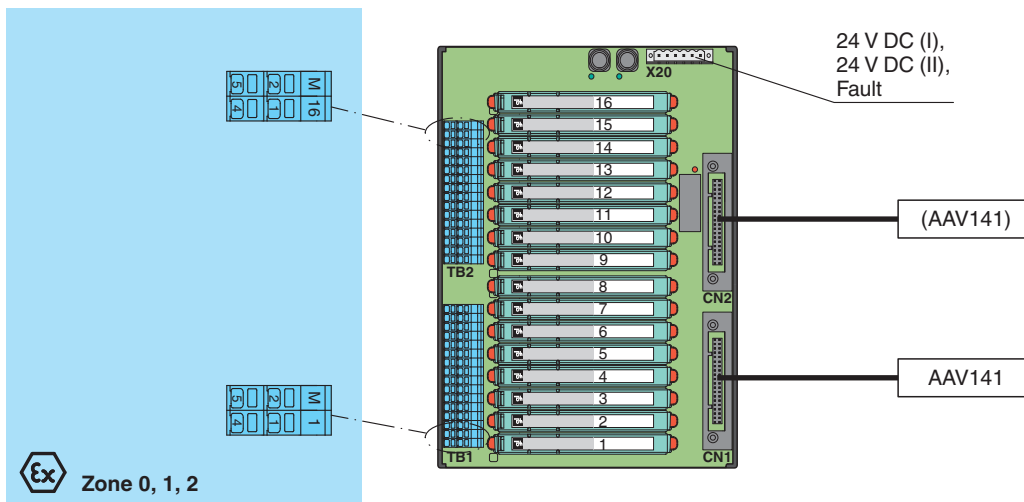

Technical Data

Supply	
Connection	X20: terminals 3, 5(+); 4, 6(-)
Nominal voltage	24 V DC , in consideration of rated voltage of used isolators
Voltage drop	0.9 V , voltage drop across the series diode on the termination board must be considered
Ripple	≤ 10 %
Fusing	4 A , in each case for 16 modules
Power dissipation	≤ 500 mW , without modules
Reverse polarity protection	yes
Redundancy	
Supply	Redundancy available. The supply for the isolators is decoupled, monitored and fused.

Release date: 2022-10-06 Date of issue: 2022-10-07 Filename: 250385_eng.pdf

Refer to "General Notes Relating to Pepperl+Fuchs Product Information".

Pepperl+Fuchs Group
www.pepperl-fuchs.com

USA: +1 330 486 0002
pa-info@us.pepperl-fuchs.com

Germany: +49 621 776 2222
pa-info@de.pepperl-fuchs.com

Singapore: +65 6779 9091
pa-info@sg.pepperl-fuchs.com

PEPPERL+FUCHS

Technical Data

Fault indication output	
Connection	X20: terminals 1, 2
Output type	volt-free contact
Switch behaviour	no fault: relay contact closed power supply fault: relay contact open module fault: relay contact open
Contact loading	30 V DC , 1 A
Indicators/settings	
Display elements	LEDs PWR ON (Termination Board power supply) - LED power supply I, green LED - LED power supply II, green LED LED FAULT (fault indication), red LED - LED lits: module fault - LED flashes: power supply fault
Directive conformity	
Electromagnetic compatibility	
Directive 2014/30/EU	EN 61326-1:2013 (industrial locations)
Conformity	
Electromagnetic compatibility	NE 21:2017 For further information see system description.
Degree of protection	IEC 60529:2001
Ambient conditions	
Ambient temperature	-20 ... 60 °C (-4 ... 140 °F)
Storage temperature	-40 ... 70 °C (-40 ... 158 °F)
Mechanical specifications	
Degree of protection	IP20
Connection	
Field side	explosion hazardous area: spring terminals , blue
Control side	non-explosion hazardous area: Yokogawa system connector, 40-pin
Supply	pluggable screw terminals , black
Fault output	pluggable screw terminals , black
Core cross section	spring terminals: rigid: 0.2 ... 2.5 mm ² flexible: 0.25 ... 1.5 mm ²
Material	housing: polycarbonate
Mass	approx. 645 g
Dimensions	240 x 175 x 153 mm (9.45 x 6.9 x 6.02 inch) (W x H x D) , depth including module assembly
Mounting	on 35 mm DIN mounting rail acc. to EN 60715:2001
Data for application in connection with hazardous areas	
EU-type examination certificate	CESI 06 ATEX 022
Marking	⊕ II (1)G [Ex ia Ga] IIC ⊕ II (1)D [Ex ia Da] IIIC ⊕ I (M1) [Ex ia Ma] I
Non-hazardous area	
Maximum safe voltage	250 V (Attention! U _m is no rated voltage.)
Galvanic isolation	
Field circuit/control circuit	safe electrical isolation acc. to IEC/EN 60079-11, voltage peak value 375 V
Directive conformity	
Directive 2014/34/EU	EN IEC 60079-0:2018+AC:2020 , EN 60079-11:2012 , EN 50303:2000
International approvals	
IECEX approval	
IECEX certificate	IECEX CES 06.0003
IECEX marking	[Ex ia Ga] IIC [Ex ia Da] IIIC [Ex ia Ma] I
General information	
Supplementary information	Observe the certificates, declarations of conformity, instruction manuals, and manuals where applicable. For information see www.pepperl-fuchs.com .

Release date: 2022-10-06 Date of issue: 2022-10-07 Filename: 250385_eng.pdf

Accessories

	HiALC-HICTB-SET-108	Label carrier for HiC termination boards
---	----------------------------	--

Release date: 2022-10-06 Date of issue: 2022-10-07 Filename: 250385_eng.pdf

Refer to "General Notes Relating to Pepperl+Fuchs Product Information".

Pepperl+Fuchs Group
www.pepperl-fuchs.com

USA: +1 330 486 0002
pa-info@us.pepperl-fuchs.com

Germany: +49 621 776 2222
pa-info@de.pepperl-fuchs.com

Singapore: +65 6779 9091
pa-info@sg.pepperl-fuchs.com

Application

Typical circuit

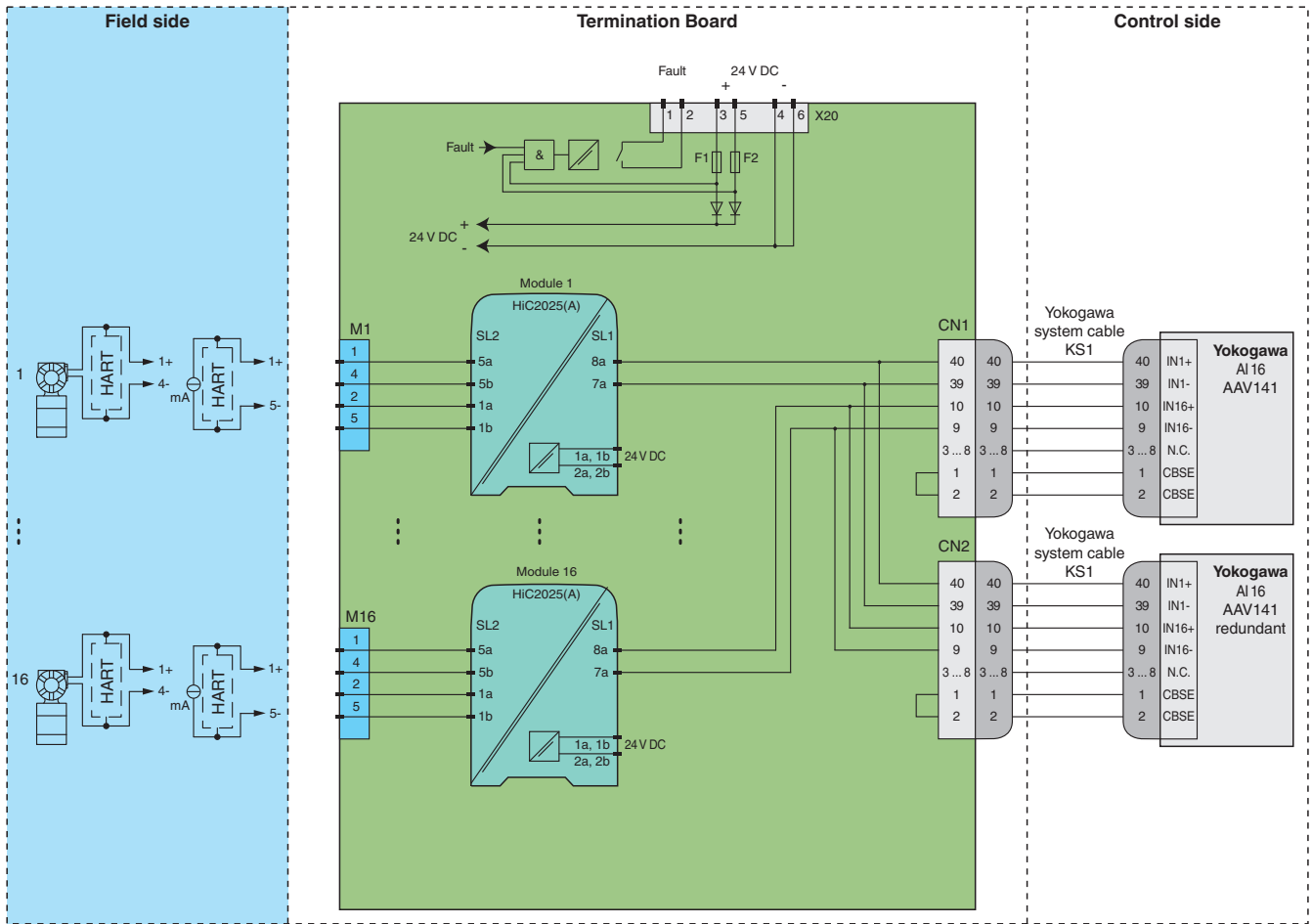

Module switch settings

Type (AI)	DIP switch	Position
HiC2025, HiC2025A (voltage source 1 V ... 5 V)	S1	OFF
	S2	OFF
	S3	ON
	S4	ON



For exact pin assignment for connection to field side and control side, see the documentation of the isolated barrier.



The pin-out configuration has to be observed. For information see corresponding pin-out table on www.pepperl-fuchs.com.