

Description of device functions

Proline t-mass 65

Thermal mass flowmeter

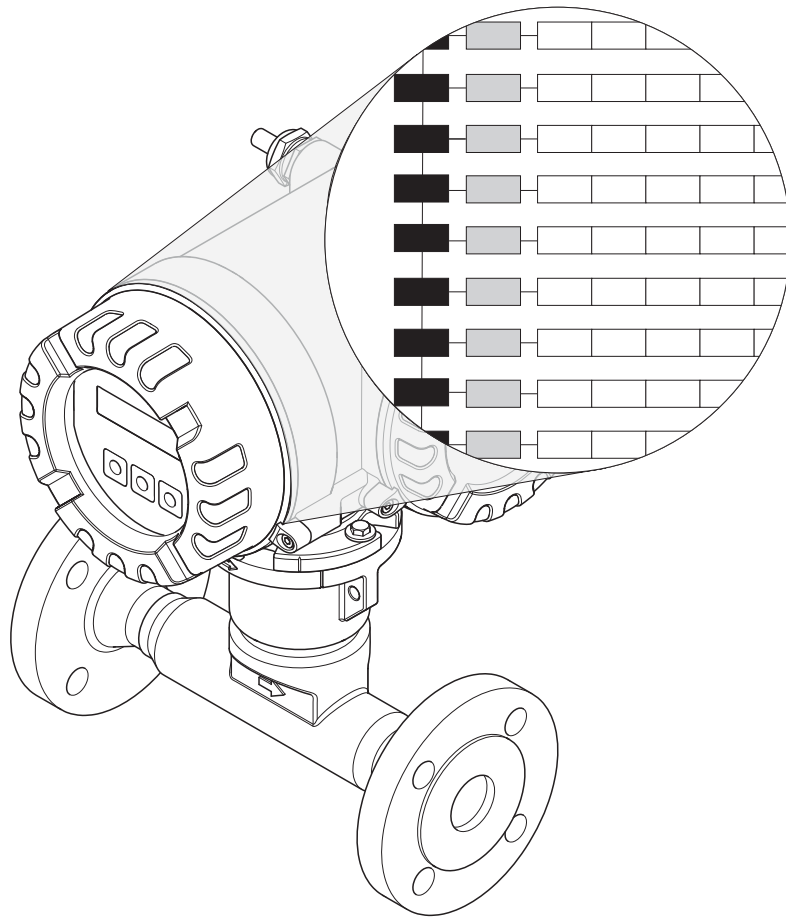

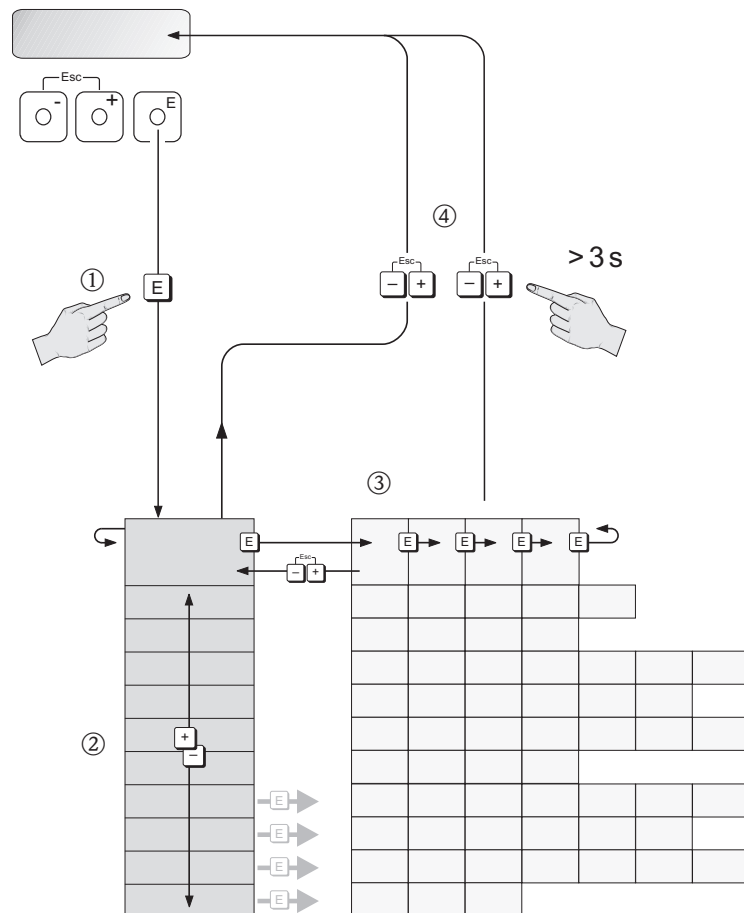

Table of contents

1	The function matrix: layout and use . . .	4	14	STATUS INPUT	52
2	Illustration of the function matrix.	5	15	CURRENT INPUT	54
3	MEASURING VALUES	8	16	COMMUNICATION	56
4	SYSTEM UNITS	9	17	PROCESS PARAMETER.	58
5	SPECIAL UNITS.	14	18	GAS	62
6	QUICK SETUP	15	19	HEAT FLOW	67
7	OPERATION.	17	20	SYSTEM PARAMETER	69
8	USER INTERFACE.	19	21	SENSOR DATA	70
9	TOTALIZER 1/2.	22	22	SUPERVISION.	74
10	HANDLING TOTALIZER.	24	23	SIMULATION SYSTEM	76
11	CURRENT OUTPUT 1/2	25	24	SENSOR VERSION	77
12	PULSE, FREQUENCY, STATUS	30	25	AMPLIFIER VERSION	78
13	RELAY OUTPUT 1/2.	47	26	Factory settings.	79
13.1	Group RELAY OUTPUT 1/2	47	26.1	Language →  17	79
13.2	Information on the response of the relay output	50	26.2	SI units (not for USA and Canada)	79
			26.3	US units (only for USA and Canada)	81
				Index	83

1 The function matrix: layout and use

The function matrix is a two-level construct: the groups form one level and the groups' functions the other. The groups are the highest-level grouping of the control options for the measuring device. A number of functions is assigned to each group. You select a group in order to access the individual functions for operating and configuring the measuring device. An overview of all the groups available is provided in the table of contents on page 3 and in the graphic representation of the function matrix on page 6. Page 6 also contains an overview of all the functions available with the page references to the specific function description. A description of the individual functions is provided on page 7 and onwards.



A0001142

2 Illustration of the function matrix

Groups/function groups		Functions			
MEASURING VALUES	→ 8	MASS FLOW	CORRECTED VOLUME FLOW	HEAT FLOW	TEMPERATURE
↓					
SYSTEM UNITS	→ 9	UNIT MASS FLOW	UNIT MASS	UNIT CORRECTED VOLUME FLOW	UNIT CORRECTED VOLUME
↓					
		UNIT CALORIFIC VALUE MASS	UNIT CALORIFIC VALUE CORRECTED VOLUME	UNIT HEAT FLOW	UNIT HEAT
		UNIT PRESSURE	UNIT TEMPERATURE	UNIT DENSITY	UNIT LENGTH
SPECIAL UNITS	→ 14	TEXT ARBITRARY MASS	FACTOR ARBITRARY MASS		
↓					
QUICK SETUP	→ 15	QUICK SETUP COMMISSIONING	QUICK SETUP SENSOR	QUICK SETUP GAS	QUICK SETUP PRESSURE
↓					
		QUICK SETUP HEAT FLOW	T-DAT SAVE/LOAD		
OPERATION	→ 17	LANGUAGE	ACCESS CODE	DEFINE PRIVATE CODE	STATUS ACCESS
↓					
		ACCESS CODE COUNTER			
USER INTERFACE	→ 19	ASSIGN LINE 1	ASSIGN LINE 2	100% VALUE LINE 1	100% VALUE LINE 2
↓					
		FORMAT	DISPLAY DAMPING	CONTRAST LCD	BACKLIGHT
↓					
		TEST DISPLAY			
TOTALIZER 1/2	→ 22	ASSIGN TOTALIZER	ASSIGN GAS GROUP	SUM	OVERFLOW
↓					
		UNIT TOTALIZER	RESET TOTALIZER		
HANDLING TOTALIZER	→ 24	RESET ALL TOTALIZERS	FAILSAFE MODE		
CURRENT OUTPUT 1/2	→ 25	ASSIGN CURRENT	ASSIGN GAS GROUP	CURRENT SPAN	VALUE 0_4 mA

Groups/function groups

Functions

↓

VALUE 20 mA	TIME CONSTANT	FAILSAFE MODE	ACTUAL CURRENT
SIMULATION CURRENT	VALUE SIMULATION CURRENT		

PULSE, FREQUENCY, STATUS

→ 30

↓

OPERATING MODE	ASSIGN FREQUENCY	ASSIGN GAS GROUP	START VALUE FREQUENCY
END VALUE FREQUENCY	VALUE-f LOW	VALUE-f HIGH	OUTPUT SIGNAL
TIME CONSTANT	FAILSAFE MODE	FAILSAFE VALUE	ACTUAL FREQUENCY
SIMULATION FREQUENCY	VALUE SIMULATION FREQUENCY	ASSIGN PULSE	ASSIGN GAS GROUP
PULSE VALUE	PULSE WIDTH	OUTPUT SIGNAL	FAILSAFE MODE
SIMULATION PULSE	VALUE SIMULATION PULSE	ASSIGN STATUS	SWITCH-ON POINT
SWITCH-OFF POINT	TIME CONSTANT	ACTUAL STATUS	SIMULATION SWITCH POINT
VALUE SIMULATION SWITCH POINT			

RELAY OUTPUT 1/2

→ 47

↓

ASSIGN RELAY	SWITCH-ON POINT	SWITCH-ON DELAY	SWITCH-OFF POINT
SWITCH-OFF DELAY	TIME CONSTANT	ACTUAL STATUS RELAY	SIMULATION SWITCH POINT
VALUE SIMULATION SWITCH POINT			

STATUS INPUT

→ 52

↓

ASSIGN STATUS INPUT	ACTIVE LEVEL	MINIMUM PULSE WIDTH	ACTUAL STATUS INPUT
SIMULATION STATUS INPUT	VALUE SIMULATION STATUS INPUT		

CURRENT INPUT

→ 54

↓

ASSIGN CURRENT INPUT	CURRENT SPAN	VALUE 0_4 mA	VALUE 20 mA
FAILSAFE VALUE	ACTUAL CURRENT INPUT	SIMULATION CURRENT INPUT	VALUE SIMULATION CURRENT INPUT

COMMUNICATION

→ 56

↓

TAG NAME	TAG DESCRIPTION	FIELD BUS ADDRESS	HART PROTOCOL
WRITE PROTECTION	MANUFACTURER ID	DEVICE ID	DEVICE REVISION



PROCESS PARAMETER

→ 58



PROCESS PRESSURE 1	PROCESS PRESSURE 2	PROCESS PRESSURE	REFERENCE PRESSURE
--------------------	--------------------	------------------	--------------------





Groups/function groups		Functions			
		REFERENCE TEMPERATURE	REFERENCE DENSITY	NET CALORIFIC VALUE	GROSS CALORIFIC VALUE
	↓	MOLE % GAS 1	ASSIGN LOW FLOW CUT OFF	ON-VALUE LOW FLOW CUT OFF	OFF-VALUE LOW FLOW CUT OFF
		ZERO POINT ADJUST	INSTALLATION FACTOR		
GAS	→ 62	SELECT GROUP	ANALYZER INPUT	NUMBER OF GASES	GAS TYPE 1
	↓	MOLE % GAS 1	DESCRIPTION	CORRECTION FACTOR	REFERENCE DENSITY
		GAS TYPE 2 to 8	MOLE % GAS 2 to 8	CHECK VALUES	SAVE CHANGES
HEAT FLOW	→ 67	CALORIFIC VALUE TYPE	MODE 1	HEATING VALUE 1	MODE 2
	↓	HEATING VALUE 2	REFERENCE COMBUSTION TEMPERATURE		
SYSTEM PARAMETER	→ 69	POSITIVE ZERO RETURN	FLOW DAMPING		
	↓				
SENSOR DATA	→ 70	PIPE TYPE	PIPE STANDARD	NOMINAL DIAMETER	OUTER DIAMETER
	↓	WALL THICKNESS	INTERNAL DIAMETER	INTERNAL HEIGHT	INTERNAL WIDTH
		MOUNTING	MOUNTING SET LENGTH	INSERTION DEPTH	FLOW CONDITIONER
		CALIBRATION DATE			
SUPERVISION	→ 74	ACTUAL SYSTEM CONDITION	PREVIOUS SYSTEM CONDITION	ASSIGN SYSTEM ERROR	ERROR CATEGORY
	↓	ASSIGN PROCESS ERROR	ERROR CATEGORY	ALARM DELAY	SYSTEM RESET
		OPERATION HOURS	HOURS SINCE RESET		
SIMULATION SYSTEM	→ 76	SIMULATION FAILSAFE MODE	SIMULATION MEASURAND	VALUE SIMULATION MEASURAND	
	↓				
SENSOR VERSION	→ 77	SENSOR TYPE	SERIAL NUMBER	TRANSDUCER SERIAL NUMBER	SOFTWARE REVISION NUMBER S-DAT
	↓	PRE-AMPLIFIER SOFTWARE REVISION NUMBER	PRE-AMPLIFIER HARDWARE REVISION NUMBER		
AMPLIFIER VERSION	→ 78	DEVICE SOFTWARE	HARDWARE REVISION NUMBER AMPLIFIER	SOFTWARE REVISION NUMBER AMPLIFIER	SOFTWARE REVISION NUMBER T-DAT
		I/O MODULE TYPE	SOFTWARE REVISION NUMBER I/O MODULE	SUB-I/O MODULE TYPE	SOFTWARE REVISION NUMBER SUB-I/O TYPE

3 MEASURING VALUES









Function description, MEASURING VALUES group	
 Note! The engineering unit of the measured variable displayed here is configured in the SYSTEM UNITS group (→  9)	
MASS FLOW	Description The currently measured mass flow appears on the display. Display: 5-digit floating-point number, including unit e.g. 462.87 kg/h; 731.63 lb/min
CORRECTED VOLUME FLOW	Description The calculated corrected volume flow appears on the display. The corrected volume flow is calculated from the measured mass flow and the reference density of the gas. Display: 5-digit floating-point number, including unit e.g. 104.97 Nm ³ /h; 110.73 Sm ³ /h; etc.
HEAT FLOW	Description The calculated heat flow appears on the display. Display: 5-digit floating-point number, including unit, (e.g. 175.00 kJ/h; 50.000 kBtu/h; etc.)
TEMPERATURE	Description The currently measured temperature appears on the display. Display: 5-digit fixed-point number, incl. unit and sign e.g. -23.4 °C, 160.0 °F, 295.4 K

4 SYSTEM UNITS

Function description, SYSTEM UNITS group	
UNIT MASS FLOW	<p>Description For selecting the unit required and displayed for the mass flow. The unit you select here is also valid for:</p> <ul style="list-style-type: none"> ▪ Current output ▪ Frequency output ▪ Switch points (limit value for mass flow) ▪ Low flow cut off <p>The following time units can be selected: s = second, m = minute, h = hour, d = day</p> <p>Options</p> <p>SI: Gram → g/time unit Kilogram → kg/time unit Metric ton → t/time unit</p> <p>US: Ounce → oz/time unit Pound → lb/time unit Ton → ton/time unit</p> <p>Special units (see TEXT ARBITRARY MASS function (→ 14)) _____[®] _____/s; _____/min; _____/h; _____/d</p> <p> Note! If a unit for mass was defined in the SPECIAL UNITS function group (→ 14), this unit is displayed here.</p> <p>Factory setting kg/h or lb/h (country dependent → 79)</p>
UNIT MASS	<p>Description For selecting the unit required and displayed for the mass. The unit you select here is also valid for:</p> <ul style="list-style-type: none"> ▪ Pulse value (e.g. kg/p) <p>Options</p> <p>SI: Gram → g Kilogram → kg Metric ton → t</p> <p>US: Ounce → oz Pound → lb Ton → ton</p> <p>Special units (see TEXT ARBITRARY MASS function (→ 14)) _____[®] _____</p> <p> Note!</p> <ul style="list-style-type: none"> ▪ If a unit for mass was defined in the SPECIAL UNITS function group (→ 14), this unit is displayed here. ▪ The unit for the totalizer is independent of the option selected here; it is selected in the TOTALIZER 1/2 function group (→ 22). <p>Factory setting kg or lb (country dependent → 79)</p>

Function description, SYSTEM UNITS group	
UNIT CORRECTED VOLUME FLOW	<p>Description For selecting the unit required and displayed for the corrected volume flow. The unit you select here is also valid for:</p> <ul style="list-style-type: none"> ■ Current output ■ Frequency output ■ Relay switch points (limit value for corrected volume flow) ■ Low flow cut off <p>The following time units can be selected: s = second, m = minute, h = hour, d = day</p> <p>Options</p> <p>SI: Norm cubic meter → Nm³/time unit Norm liter → NI/time unit</p> <p>US: Standard cubic meter → Sm³/time unit Standard cubic feet → Sft³/time unit</p> <p>Factory setting Nm³/h or Sm³/h (country dependent →  79)</p>
UNIT CORRECTED VOLUME	<p>Description For selecting the unit required and displayed for the corrected volume. The unit you select here is also valid for:</p> <ul style="list-style-type: none"> ■ Pulse value (e.g. Nm³/p) <p>Options</p> <p>SI: Norm cubic meter → Nm³ Norm liter → NI</p> <p>US: Standard cubic meter → Sm³ Standard cubic feet → Sft³</p> <p> Note! The unit for the totalizer is independent of the option selected here; it is selected in the TOTALIZER 1/2 function group (→  22).</p> <p>Factory setting Nm³ or Sm³ (country dependent →  79)</p>
UNIT CALORIFIC VALUE MASS	<p>Description For selecting the unit required and displayed for the gross/net calorific value.</p> <p>Options (SI units)</p> <p>kJ/kg MJ/kg kWh/kg MWh/kg kcal/kg Mcal/kg</p> <p>Options (US units)</p> <p>Btu/lb kBtu/lb</p> <p>Factory setting MJ/kg or kBtu/lb (country dependent →  79)</p>

Function description, SYSTEM UNITS group	
<p>UNIT CALORIFIC VALUE CORRECTED VOLUME</p>	<p>Description For selecting the unit required and displayed for the calorific value based on the corrected volume.</p> <p>Options (SI units): kJ/Nm³ MJ/Nm³ kWh/Nm³ MWh/Nm³ kcal/Nm³ Mcal/Nm³</p> <p>Options (US units): kJ/Sm³ MJ/Sm³ kWh/Sm³ MWh/Sm³ kcal/Sm³ Mcal/Sm³ Btu/Sft³ kBtu/Sft³</p> <p>Factory setting MJ/Nm³ or kBtu/Sft³ (country dependent → 79)</p>
<p>UNIT HEAT FLOW</p>	<p>Description For selecting the unit required and displayed for the heat flow. The unit you select here is also valid for:</p> <ul style="list-style-type: none"> ■ Current output ■ Frequency output ■ Relay switch points (limit value for heat flow) <p>The following time units can be selected: s = second, m = minute, h = hour, d = day</p> <p>Options (SI unit) kW MW kJ/time unit MJ/time unit GJ/time unit kcal/time unit Mcal/time unit Gcal/time unit</p> <p>Options (US unit) tons kBtu/time unit MBtu/time unit GBtu/time unit</p> <p>Factory setting kW or kBtu/h (country dependent → 79)</p>

Function description, SYSTEM UNITS group	
UNIT HEAT	<p>Description For selecting the unit required and displayed for the heat. The unit you select here is also valid for:</p> <ul style="list-style-type: none"> ■ Pulse output (see PULSE, FREQUENCY, STATUS group →  30) <p>The following time units can be selected: s = second, m = minute, h = hour, d = day</p> <p>Options (SI units) kWh MWh kJ MJ GJ kcal Mcal Gcal</p> <p>Options (US units) tonh kBtu MBtu GBtu</p> <p> Note! The unit for the totalizer is independent of the option selected here; it is selected in the TOTALIZER 1/2 function group (→  22).</p> <p>Factory setting kWh or kBtu (country dependent →  79)</p>
UNIT PRESSURE	<p>Description Use this function to select the unit for pressure.</p> <p>The unit you select here is also valid for:</p> <ul style="list-style-type: none"> ■ Process pressure (see PROCESS PARAMETER group, →  58) ■ Reference pressure (see PROCESS PARAMETER group, →  58) <p>Options bar a (bar absolute) psi a (pound per square inch absolute) kPa a (kilopascal absolute) mmHg 0°C a (millimeter mercury absolute) inHg 32°F a (inch mercury absolute) mmH2O 4°C a (millimeter water absolute) inH2O 39°F a (inch water absolute) kg/cm² a (kilogram per centimeter squared absolute)</p> <p>Factory setting bar a or psi a (country dependent →  79)</p>
UNIT TEMPERATURE	<p>Description For selecting the unit required and displayed for the temperature. The unit you select here is also valid for:</p> <ul style="list-style-type: none"> ■ Current output ■ Frequency output ■ Relay switch points (limit value for temperature) <p>Options °C (CELSIUS) K (KELVIN) °F (FAHRENHEIT) R (RANKINE)</p> <p>Factory setting °C or °F (country dependent →  79)</p>

Function description, SYSTEM UNITS group	
UNIT DENSITY	<p>Description For selecting the unit required and displayed for the calculated gas density at process conditions. The unit you select here is also valid for:</p> <ul style="list-style-type: none"> Reference density (see PROCESS PARAMETER group, → 58) <p>Options SI: g/cm³ g/cc kg/dm³ kg/l kg/m³ US: lb/ft³</p> <p>Factory setting kg/m³ or lb/ft³ (country dependent → 79)</p>
UNIT LENGTH	<p>Prerequisite This function is only available for the insertion sensor (t-mass 65I)</p> <p>Description For selecting the unit of length required and displayed for the pipe internal diameter or the inner dimensions of rectangular ducts (see SENSOR DATA function group → 70).</p> <p>Options MILLIMETER INCH</p> <p>Factory setting MILLIMETER or INCH (country dependent → 79)</p>

5 SPECIAL UNITS





Function description, SPECIAL UNITS group	
TEXT ARBITRARY MASS	<p>Description For entering a text for a mass flow unit of the user's choice. You only define the text, the associated unit of time is selected in the UNIT MASS FLOW or UNIT MASS function (→ page 9). The mass unit defined is offered as a possible option (arbitrary mass unit) in the UNIT MASS FLOW or UNIT MASS function.</p> <p>Options xxxx (max. 4 characters) Valid characters are A-Z, 0-9, +, -, decimal point, white space or underscore</p> <p>Factory setting "- - -" (no text)</p>
FACTOR ARBITRARY MASS	<p>Prerequisite This function is only available if a text was entered in the TEXT ARBITRARY MASS function (→ 14).</p> <p>Description For entering a quantity factor (without time) for the arbitrary mass flow unit. This factor refers to the mass of one kilogram.</p> <p>User input 7-digit floating-point number</p> <p>Factory setting 1.0 / kg</p>

6 QUICK SETUP

Function description, QUICK SETUP group	
QUICK SETUP COMMISSIONING	<p>Description Starts the Quick Setup menu for commissioning. For a flowchart of the COMMISSIONING QUICK SETUP, see Operating Instructions BA00111D/06.</p> <p>Options NO YES</p> <p>Factory setting NO</p>
QUICK SETUP SENSOR	<p>Prerequisite This function is only available for insertion sensors (t-mass 65I).</p> <p>Description Use this function to start the application-specific setup to calculate the insertion depth for the insertion sensor. For a flowchart of the SENSOR QUICK SETUP, see Operating Instructions BA00111D/06.</p> <p>Options NO YES</p> <p>Factory setting NO</p>
QUICK SETUP GAS	<p>Description Use this function to start the application-specific setup for programming the gas or gas mixture. For a flowchart of the GAS QUICK SETUP, see Operating Instructions BA00111D/06.</p> <p>Options NO YES</p> <p>Factory setting NO</p>
QUICK SETUP PRESSURE	<p>Description Use this function to start the application-specific setup for programming the process pressure for each gas group.</p> <p>Options NO YES</p> <p>Factory setting NO</p>
QUICK SETUP HEAT FLOW	<p>Description Use this function to start the application-specific setup for heat flow. For a flowchart of the HEAT FLOW QUICK SETUP, see Operating Instructions BA00111D/06.</p> <p>Options NO YES</p> <p>Factory setting NO</p>



Function description, QUICK SETUP group	
T-DAT SAVE/LOAD	<p>Description Use this function to save the configuration/settings of the transmitter to a transmitter-DAT (T-DAT), or to load a configuration from the T-DAT to the EEPROM (manual backup function).</p> <p>Application examples:</p> <ul style="list-style-type: none"> ▪ After commissioning, the current measuring point parameters can be saved to the T-DAT as a backup. ▪ If the transmitter is replaced for some reason, the data from the T-DAT can be loaded into the new transmitter (EEPROM). <p>Options CANCEL SAVE (from the EEPROM to the T-DAT) LOAD (from the T-DAT to the EEPROM)</p> <p> Note!</p> <ul style="list-style-type: none"> ▪ If the target device has an older software version, the message "TRANSM. SW-DAT" is displayed during startup. Then only the "SAVE" option is available. ▪ LOAD This option is only possible: <ul style="list-style-type: none"> - if the target device has the same software version as, or a more recent software version than, the source device or - if the T-DAT contains valid data that can be called up ▪ SAVE This function is always available. <p>Factory setting CANCEL</p>

7 OPERATION

Function description, OPERATION group	
LANGUAGE	<p>Description For selecting the language in which all messages are shown on the local display. If you press the  keys simultaneously at startup, the language defaults to "ENGLISH".</p> <p>Options: ENGLISH DEUTSCH FRANCAIS ESPANOL ITALIANO NEDERLANDS NORSK SVENSKA SUOMI PORTUGUES POLSKI CESKI</p> <p>Factory setting country dependent →  79</p>
ACCESS CODE	<p>Description All data of the measuring device are protected against inadvertent change. Programming is disabled and the settings cannot be changed until a code is entered. If you press the  operating elements in any function, the measuring device automatically goes to this function and the prompt to enter the code appears on the display (programming disabled). You can enable programming by entering the private code (factory setting = 65, see DEFINE PRIVATE CODE function (→  17)).</p> <ul style="list-style-type: none"> ▪ The programming levels are disabled if you do not press the operating elements within 60 seconds following a return to the HOME position. ▪ Programming can also be disabled by entering any number (other than the private code). ▪ Your Endress+Hauser sales center can be of assistance if you mislay your private code. <p>User input Max. 4-digit number: 0 to 9999</p>
DEFINE PRIVATE CODE	<p>Description Use this function to specify the private code for enabling programming.</p> <ul style="list-style-type: none"> ▪ Programming is always enabled if the code defined = 0. ▪ Programming has to be enabled before the code can be changed. When programming is disabled this function cannot be edited, thus preventing others from accessing your personal code. <p>User input Max. 4-digit number: 0 to 9999</p> <p>Factory setting 65</p>
STATUS ACCESS	<p>Description The access status for this function matrix appears on the display.</p> <p>Display: ACCESS CUSTOMER (parameters can be modified) LOCKED (parameters cannot be modified)</p>

Function description, OPERATION group	
ACCESS CODE COUNTER	<p>Description The number of times the private and service code was entered to access the device appears on the display.</p> <p>Display: Integer</p> <p>Factory setting 0</p>

8 USER INTERFACE

Function description, USER INTERFACE group	
<p>ASSIGN LINE 1</p>	<p>Description For assigning a display value to the main line (top line of the local display). This value is displayed during normal operation.</p> <p> Note! The option ACTUAL CURRENT INPUT is only available if the "current input" submodule is available and enabled on the measuring device (ASSIGN CURRENT → 25).</p> <p>Options OFF MASS FLOW MASS FLOW IN % TEMPERATURE TOTALIZER 1 TOTALIZER 2 CORRECTED VOLUME FLOW CORRECTED VOLUME FLOW IN % ACTUAL CURRENT INPUT HEAT FLOW HEAT FLOW IN %</p> <p>Factory setting MASS FLOW</p>
<p>ASSIGN LINE 2</p>	<p>Description For assigning a display value to the additional line (bottom line of the local display). This value is displayed during normal operation.</p> <p> Note! The option ACTUAL CURRENT INPUT only available if the "current input" submodule is available and enabled on the measuring device (ASSIGN CURRENT → 25).</p> <p>Options OFF MASS FLOW MASS FLOW IN % MASS FLOW BARGRAPH IN % TEMPERATURE TOTALIZER 1 TAG NAME OPERATING/SYSTEM CONDITIONS TOTALIZER 2 CORRECTED VOLUME FLOW CORRECTED VOLUME FLOW IN % CORRECTED VOLUME FLOW BARGRAPH IN % ACTUAL CURRENT INPUT HEAT FLOW HEAT FLOW IN % HEAT FLOW BARGRAPH IN %</p> <p>Factory setting TOTALIZER 1</p>

Function description, USER INTERFACE group	
100% VALUE LINE 1	<p>Prerequisite This function is only available if one of the following options was selected in the ASSIGN LINE 1 function (→ 19):</p> <ul style="list-style-type: none"> ■ MASS FLOW IN % ■ CORRECTED VOLUME FLOW IN % ■ HEAT FLOW IN % <p>Description Use this function to enter the flow value which should be shown on the display as the 100% value.</p> <p>User input 5-digit floating-point number</p> <p>Factory setting 10 kg/h (with mass flow) 10 Nm³/h (with corrected volume flow) 10 kW (with heat flow)</p>
100% VALUE LINE 2	<p>Prerequisite This function is only available if one of the following options was selected in the ASSIGN LINE 2 function (→ 19):</p> <ul style="list-style-type: none"> ■ MASS FLOW IN % ■ CORRECTED VOLUME FLOW IN % ■ HEAT FLOW IN % ■ MASS FLOW BARGRAPH IN % ■ CORRECTED VOLUME FLOW BARGRAPH IN % ■ HEAT FLOW BARGRAPH IN % <p>Description Use this function to enter the flow value which should be shown on the display as the 100% value.</p> <p>User input 5-digit floating-point number</p> <p>Factory setting 10 kg/h (with mass flow) 10 Nm³/h (with corrected volume flow) 10 kW (with heat flow)</p>
FORMAT	<p>Description For selecting the number of decimal places for the display value in the main line.</p> <ul style="list-style-type: none"> ■ Note that this setting only affects the reading as it appears on the display, it has no influence on the accuracy of the system's calculations. ■ The places after the decimal point as computed by the measuring device cannot always be displayed, depending on this setting and the engineering unit. In these instances an arrow appears on the display between the measured value and the engineering unit (e.g. 1.2 → kg/h), indicating that the measuring device is computing with more decimal places than can be shown on the display. <p>Options XXXXX. - XXXX.X - XXX.XX - XX.XXX -X.XXXX</p> <p>Factory setting X.XXXX</p>
DISPLAY DAMPING	<p>Description For entering a time constant defining how the display reacts to severely fluctuating flow variables, either very quickly (enter a low time constant) or with damping (enter a high time constant). The setting 0 seconds switches off damping.</p> <p>User input 0 to 100 seconds</p> <p>Factory setting 3 seconds</p>

Function description, USER INTERFACE group	
CONTRAST LCD	<p>Description For adjusting the display contrast to suit local operating conditions.</p> <p>User input 10 to 100%</p> <p>Factory setting 50%</p>
BACKLIGHT	<p>Description For adjusting the background lighting to suit local operating conditions. Entering the value "0" means that the backlight is "switched off". The display then no longer emits any light, i.e. the display texts can no longer be read in the dark.</p> <p>User input 0 to 100%</p> <p>Factory setting 50%</p>
TEST DISPLAY	<p>Description Use this function to test the operability of the local display and its pixels.</p> <p>Test sequence:</p> <ol style="list-style-type: none"> 1. Start the test by selecting ON. 2. All pixels of the main line and additional line are darkened for minimum 0.75 seconds. 3. The main line and additional line show an "8" in each field for minimum 0.75 seconds. 4. The main line and additional line show a "0" in each field for minimum 0.75 seconds. 5. The main line and additional line show nothing (blank display) for minimum 0.75 seconds. 6. When the test is completed, the local display returns to its initial state and displays the option OFF. <p>Options OFF ON</p> <p>Factory setting OFF</p>

9 TOTALIZER 1/2

Function description, TOTALIZER 1/2 group	
ASSIGN TOTALIZER	<p>Description Use this function to assign a measured variable to the totalizer.</p> <ul style="list-style-type: none"> ▪ The totalizer is reset to "0" as soon as the option selected is changed. ▪ If you select OFF, only the ASSIGN TOTALIZER function is displayed in the Totalizer 1 or 2 group. <p>Options: OFF MASS FLOW CORRECTED VOLUME FLOW HEAT FLOW</p> <p>Factory setting MASS FLOW</p>
ASSIGN GAS GROUP	<p>Description Use this function to assign a gas group to a totalizer.</p> <p>If GAS GROUP 1&2 is selected, the individual values of each gas group are totaled on one totalizer.</p> <p>Options: GAS GROUP 1 GAS GROUP 2 GAS GROUP 1&2</p> <p>Factory setting GAS GROUP 1</p>
SUM	<p>Description The total for the totalizer's measured variable aggregated since measuring commenced appears on the display. The value is positive.</p> <p>The totalizers' response to errors is defined in the FAILSAFE MODE function (→ 24).</p> <p>Display: Max. 7-digit floating-point number, including unit (e.g. 15467.04 kg)</p>
OVERFLOW	<p>Description The total for the totalizer's overflow aggregated since measuring commenced appears on the display.</p> <p>Total flow is represented by a floating-point number consisting of max. 7 digits. Higher numerical values (>9,999,999) can be viewed as overflows. The effective quantity is thus the total of the SUM function (→ 22) plus the value displayed in the OVERFLOW function.</p> <p>Example: Reading after 2 overflows: 2 E7 kg (= 20 000 000 kg) The value displayed in the SUM function = 196 845.7 kg Effective total quantity = 20 196 845.7 kg</p> <p>Display: Integer with exponent, including unit, e.g. 2 E7 kg</p>

Function description, TOTALIZER 1/2 group	
UNIT TOTALIZER	<p>Description For selecting the unit for the measured variable assigned to the totalizer.</p> <p>Options (ASSIGN TOTALIZER = MASS FLOW): SI → g , kg, t US → oz, lb, ton</p> <p>Arbitrary unit → _ _ _ _ (see TEXT ARBITRARY MASS function → 14)</p> <p>Factory setting Depends on the nominal diameter and the country → 79</p> <p>Options (ASSIGN TOTALIZER = CORRECTED VOLUME FLOW): SI → l, Nm³ US → Sm³, Sft³</p> <p>Factory setting Depends on the nominal diameter and the country → 79</p> <p>Options (ASSIGN TOTALIZER = HEAT FLOW): SI → kWh, MWh, kJ, MJ, GJ, kcal, Mcal, Gcal US → kBtu, MBtu, GBtu, tonh</p> <p>Factory setting MWh or kBtu (country dependent → 79)</p>
RESET TOTALIZER	<p>Description Resets the sum and overflow in the totalizer selected.</p> <p>Options NO YES</p> <p>Factory setting NO</p>

10 HANDLING TOTALIZER

Function description, HANDLING TOTALIZER group	
RESET ALL TOTALIZERS	<p>Description Resets the sums and overflows of both totalizers to "zero" (=RESET). If the device is equipped with a status input and if it is appropriately configured, a totalizer reset (totalizers 1 and 2) can also be triggered by a pulse (see ASSIGN STATUS INPUT function on Page → 52).</p> <p>Options NO YES</p> <p>Factory setting NO</p>
FAILSAFE MODE	<p>Description For selecting the behavior of the totalizer in an alarm condition.</p> <p>Options STOP The totalizer does not continue to count the flow if a fault is present. The totalizer stops at the last value before the alarm condition occurred. HOLD VALUE The totalizer continues to count the flow on the basis of the last valid flow data (before the fault occurred). ACTUAL VALUE The totalizers continue to count on the basis of the current flow data. The fault is ignored.</p> <p>Factory setting STOP</p>



11 CURRENT OUTPUT 1/2

Function description, CURRENT OUTPUT 1/2 group	
ASSIGN CURRENT	<p>Description Use this function to assign a measured variable to the current output.</p> <p>Options OFF MASS FLOW CORRECTED VOLUME FLOW TEMPERATURE HEAT FLOW</p> <p>Factory setting If you select OFF, the only function shown in this group is the ASSIGN CURRENT function.</p>
ASSIGN GAS GROUP	<p>Description Use this function to assign a gas group to a current output. If GAS GROUP 1&2 is selected, the individual values of each gas group are assigned to one current output.</p> <p>Options: GAS GROUP 1 GAS GROUP 2 GAS GROUP 1&2</p> <p>Factory setting GAS GROUP 1</p>
CURRENT SPAN	<p>Description Use this function to select the current span. The option selected defines the operational range and the upper and lower signal on alarm. The HART option can also be defined for current output 1.</p> <p> Note!</p> <ul style="list-style-type: none"> ▪ The HART option is only supported by the current output designated as current output 1 in the device software, (terminals 26 and 27). ▪ When switching the hardware from an active (factory setting) to a passive output signal, select a current span of 4–20 mA (see Operating Instructions BA00111D/06) <p>Options 0–20 mA 4–20 mA 4–20 mA HART (only for current output 1) 4–20 mA NAMUR 4–20 mA HART NAMUR (only for current output 1) 4–20 mA US 4–20 mA HART US (only for current output 1) 0–20 mA (25 mA) 4–20 mA (25 mA) 4–20 mA (25 mA) HART (only for current output 1)</p> <p>Factory setting 4–20 mA HART NAMUR (for current output 1) 4–20 mA NAMUR (for all other current outputs)</p>



Function description, CURRENT OUTPUT 1/2 group																													
CURRENT SPAN (contd.)	<p>Current span, operational range and signal on alarm level</p> <table border="1"> <thead> <tr> <th></th> <th>1</th> <th>2</th> <th>3</th> </tr> </thead> <tbody> <tr> <td>0 - 20.5 mA</td> <td></td> <td>0</td> <td>22</td> </tr> <tr> <td>4 - 20.5 mA</td> <td></td> <td>2</td> <td>22</td> </tr> <tr> <td>3.8 - 20.5 mA</td> <td></td> <td>3.5</td> <td>22.6</td> </tr> <tr> <td>3.9 - 20.8 mA</td> <td></td> <td>3.75</td> <td>22.6</td> </tr> <tr> <td>0 - 24 mA</td> <td></td> <td>0</td> <td>25</td> </tr> <tr> <td>4 - 24 mA</td> <td></td> <td>2</td> <td>25</td> </tr> </tbody> </table> <p style="text-align: right;">A0001222</p> <p>Fig. 1: Current span, operational range and signal on alarm level</p> <p><i>a</i> = Current span ① = Operational range ② = Lower signal on alarm level ③ = Upper signal on alarm level</p> <p> Note!</p> <ul style="list-style-type: none"> ■ If the measured value is outside the measuring range (defined in the VALUE 20 mA function (→ 27)), a notice message is generated (#351 to 352, "CURRENT SPAN"). ■ In the event of an error, the current output behaves in accordance with the option specified in the FAILSAFE MODE function. For a fault message to be generated, the error category has to be changed from a notice message to a fault message (ASSIGN SYSTEM ERROR). 		1	2	3	0 - 20.5 mA		0	22	4 - 20.5 mA		2	22	3.8 - 20.5 mA		3.5	22.6	3.9 - 20.8 mA		3.75	22.6	0 - 24 mA		0	25	4 - 24 mA		2	25
	1	2	3																										
0 - 20.5 mA		0	22																										
4 - 20.5 mA		2	22																										
3.8 - 20.5 mA		3.5	22.6																										
3.9 - 20.8 mA		3.75	22.6																										
0 - 24 mA		0	25																										
4 - 24 mA		2	25																										
VALUE 0_4 mA	<p>Prerequisite This function is only available if TEMPERATURE was selected in the ASSIGN CURRENT function.</p> <p>Description Assign a value to the 4 mA current. (See "Configuring the span via the 0_4 mA and 20 mA value" on → 28).</p> <p>User input 5-digit floating-point number (with sign for the TEMPERATURE measured variable)</p> <p>Factory setting (country dependent → 79)</p> <ul style="list-style-type: none"> ■ MASS FLOW: 0 [kg/h, lb/h] ■ CORRECTED VOLUME FLOW: 0 [Nm³/h, Sm³/h] ■ TEMPERATURE: 0 °C or +32 °F ■ HEAT FLOW: 0 [kW; kBtu] 																												

Function description, CURRENT OUTPUT 1/2 group	
<p>VALUE 20 mA</p>	<p>Description Assign a value to the 20 mA current. (See "Configuring the span via the 0_4 mA and 20 mA value" on → 28).</p> <p>User input 5-digit floating-point number (with sign for the MASS FLOW, CORRECTED VOLUME FLOW, HEAT FLOW and TEMPERATURE)</p> <p>Factory setting (country dependent → 79)</p> <ul style="list-style-type: none"> ■ MASS FLOW: depends on the nominal diameter [kg/h, lb/h] ■ CORRECTED VOLUME FLOW: depends on the nominal diameter [Nm³/h, Sm³/h] ■ TEMPERATURE: 100 °C or +212 °F ■ HEAT FLOW: 10 [kW; kBtu]
<p>Configuring the span via the 0_4 mA and 20 mA value</p>	<p>Description The span is determined for the measured variable selected in the ASSIGN CURRENT function by means of the VALUE 0_4 mA and VALUE 20 mA functions. The span can be defined differently depending on the measured variable selected:</p> <p>MASS FLOW, CORRECTED VOLUME FLOW and HEAT FLOW</p> <ul style="list-style-type: none"> ■ The VALUE 0_4 mA function is not available. The value for the zero flow (0 kg/h (lb/h), 0 Nm³/h (Sm³/h) or 0 MW (MBtu/h)) is assigned to the 0/4 mA current. ■ The flow value for the 20 mA current is defined in the VALUE 20 mA function (input range 0 to +99999). The unit is taken from the UNIT MASS FLOW, UNIT CORRECTED VOLUME FLOW or UNIT HEAT FLOW function. <p>Example: Value assigned to 4 mA = 0 kg/h Value assigned to 20 mA = 3000 kg/h</p> <p>TEMPERATURE</p> <ul style="list-style-type: none"> ■ The temperature value for the 0/4 mA current is defined in the VALUE 0_4 mA function (input range -99999 to +99999). The unit is taken from the UNIT TEMPERATURE function. ■ The temperature value for the 20 mA current is defined in the VALUE 20 mA function (input range -99999 to +99999). The unit is taken from the UNIT TEMPERATURE function. <p>Example: Value assigned to 4 mA = -5°C Value assigned to 20 mA = 20°C</p> <div style="text-align: center;"> </div> <p>Fig. 2: Current span, operational range and signal on alarm level</p> <p>A = Span</p> <ul style="list-style-type: none"> ① Lower-range value (0 to 20 mA) ② Lower signal on alarm level: depends on the option selected in the CURRENT SPAN function ③ Lower-range value (4 to 20 mA): depends on the option selected in the CURRENT SPAN function ④ Upper-range value (0/4 to 20 mA): depends on the option selected in the CURRENT SPAN function ⑤ Maximum current value: depends on the option selected in the CURRENT SPAN function ⑥ Upper signal on alarm level (failsafe mode): depends on the option selected in the CURRENT SPAN and FAILSAFE MODE functions

Function description, CURRENT OUTPUT 1/2 group	
TIME CONSTANT	<p>Description Depending on the value entered for the time constant, you specify how the current output signal reacts to severely fluctuating measured variables, either very quickly (enter a low time constant) or with damping (enter a high time constant).</p> <p>User input Fixed-point number: 0.0 to 100.0 s</p> <p>Factory setting 1.0 s</p>
FAILSAFE MODE	<p>Description Use this function to determine how the current output reacts in the event of a fault. The dictates of safety render it advisable to ensure that the current output assumes a predefined state in the event of a fault. The setting you select here affects only the current output. It has no effect on other outputs or the display (e.g. totalizers).</p> <p>Options</p> <p>MIN. CURRENT The current output is set to the value of the lower signal on alarm level (the values in question can be found in the CURRENT SPAN function).</p> <p>MAX. CURRENT The current output is set to the value of the upper signal on alarm level (the values in question can be found in the CURRENT SPAN function).</p> <p>HOLD VALUE Measured value output is based on the last measured value saved before the error occurred.</p> <p>ACTUAL VALUE Measured value output is based on the current flow measurement. The fault is ignored.</p> <p>Factory setting MIN. CURRENT</p>
ACTUAL CURRENT	<p>Description The current computed actual value of the output current appears on the display.</p> <p>Display: 0 to 25 mA</p>
SIMULATION CURRENT	<p>Description Activates simulation of the current output.</p> <ul style="list-style-type: none"> ▪ Notice message #611 "SIMULATION CURRENT OUTPUT" indicates that simulation is active. ▪ The measuring device continues to measure while simulation is in progress, i.e. the current measured values are output correctly via the other outputs and the display. <p> Note! The setting is not saved if the power supply fails.</p> <p>Options OFF ON</p> <p>Factory setting OFF</p>

Function description, CURRENT OUTPUT 1/2 group	
VALUE SIMULATION CURRENT	<p>Prerequisite This function is only available if ON was selected in the SIMULATION CURRENT function (→  28).</p> <p>Description Use this function to define an arbitrary value (e.g. 12 mA) which should be output at the current output. This value is used to test downstream devices and the measuring device itself.</p> <p>When you exit the function and the SIMULATION CURRENT function is activated (= ON), the message "END SIMULATION?" appears on the display. If you select YES, the simulation is terminated. If you select NO, the simulation is continued.</p> <p> Note! The setting is not saved if the power supply fails.</p> <p>User input Floating-point number: 0.00 to 25.00 mA</p> <p>Factory setting 0.00 mA</p>

12 PULSE, FREQUENCY, STATUS

Function description, PULSE, FREQUENCY, STATUS group	
OPERATING MODE	<p>Description Configuration of the output as a pulse, frequency or status output. The functions available in this function group will vary, depending on which option you select here.</p> <p> Note! The option STATUS is only available for flexible-assignment I/O boards with corresponding submodules (see Operating Instructions BA00111D).</p> <p>Options FREQUENCY PULSE STATUS</p> <p>Factory setting FREQUENCY</p>
ASSIGN FREQUENCY	<p>Prerequisite This function is only available if FREQUENCY was selected in the OPERATING MODE function (→  30).</p> <p>Description Use this function to assign a measured variable to the frequency output.</p> <p>If you select OFF, the only functions shown in this function group are the ASSIGN FREQUENCY and OPERATION MODE functions.</p> <p>Options OFF MASS FLOW CORRECTED VOLUME FLOW TEMPERATURE HEAT FLOW</p> <p>Factory setting MASS FLOW</p>
ASSIGN GAS GROUP	<p>Description Use this function to assign a gas group to a frequency output.</p> <p>If GAS GROUP 1&2 is selected, the individual values of each gas group are assigned to one frequency output.</p> <p>Options: GAS GROUP 1 GAS GROUP 2 GAS GROUP 1&2</p> <p>Factory setting GAS GROUP 1</p>
START VALUE FREQUENCY	<p>Prerequisite This function is only available if FREQUENCY was selected in the OPERATING MODE function (→  30).</p> <p>Description Use this function to define a start value frequency for the frequency output. You define the associated measured value of the measuring range in the VALUE-f LOW function.</p> <p>Example: Start value frequency = 0 Hz, VALUE f LOW = 0 kg/h: i.e. a frequency of 0 Hz is output at a flow of 0 kg/h. Start value frequency = 10 Hz, VALUE f LOW = 1 kg/h: i.e. a frequency of 10 Hz is output at a flow of 1 kg/h.</p> <p>User input 5-digit fixed-point number: 0 to 1000 Hz</p> <p>Factory setting 0 Hz</p>

Function description, PULSE, FREQUENCY, STATUS group	
<p>END VALUE FREQUENCY</p>	<p>Prerequisite This function is only available if FREQUENCY was selected in the OPERATING MODE function (→ 30).</p> <p>Description Use this function to define the end frequency for the frequency output. You define the associated measured value of the measuring range in the VALUE-f HIGH function (→ 32). In the FREQUENCY operating mode the output signal is symmetrical (on/off ratio = 1:1). At low frequencies the pulse duration is limited to a maximum of 2 seconds, i.e. the on/off ratio is no longer symmetrical.</p> <p>Example: End frequency = 1000 Hz, VALUE f HIGH = 1000 kg/h: i.e. a frequency of 1000 Hz is output at a flow of 1000 kg/h. End frequency = 1000 Hz, VALUE f HIGH = 3600 kg/h: i.e. a frequency of 1000 Hz is output at a flow of 3600 kg/h.</p> <p>User input 5-digit fixed-point number: 2 to 1000 Hz</p> <p>Factory setting 1000 Hz</p>
<p>VALUE-f LOW</p>	<p>Prerequisite This function is only available if FREQUENCY was selected in the OPERATING MODE function (→ 30).</p> <p>Description Use this function to assign a value to the start value frequency. The value entered here must be smaller than the value assigned to the VALUE-f HIGH function (→ 32). A negative value is only permitted if TEMPERATURE is selected in the ASSIGN FREQUENCY function (→ 30). You define the desired span by specifying the VALUE-f LOW and VALUE-f HIGH. The unit is taken from the SYSTEM UNITS group (→ 9).</p> <p>User input 5-digit floating-point number</p> <p>Factory setting (country dependent → 79)</p> <ul style="list-style-type: none"> ■ MASS FLOW: 0 [kg/h, lb/h] ■ CORRECTED VOLUME FLOW: 0 [Nm³/h, Sm³/h] ■ TEMPERATURE: 0 °C or +32 °F ■ HEAT FLOW: 0 [kW; kBtu]

Function description, PULSE, FREQUENCY, STATUS group	
<p>VALUE-f HIGH</p>	<p>Prerequisite This function is only available if FREQUENCY was selected in the OPERATING MODE function (→ 30).</p> <p>Description Use this function to assign a value to the end value frequency. The value entered here must be greater than the value assigned to the VALUE-f LOW function (→ 31). A negative value is only permitted if TEMPERATURE is selected in the ASSIGN FREQUENCY function (→ 30). You define the desired span by specifying the VALUE-f LOW and VALUE-f HIGH. The unit is taken from the SYSTEM UNITS group (→ 9). Example:</p> <div style="text-align: center;"> </div> <p style="text-align: right; font-size: small;">A0001279</p> <p>User input 5-digit floating-point number</p> <p>Factory setting (country dependent → 79)</p> <ul style="list-style-type: none"> ■ MASS FLOW: depends on the nominal diameter [kg/h, lb/h] ■ CORRECTED VOLUME FLOW: depends on the nominal diameter [Nm³/h, Sm³/h] ■ TEMPERATURE: 100 °C or +212 °F ■ HEAT FLOW: 10 [kW; kBtu]
<p>OUTPUT SIGNAL</p>	<p>Prerequisite This function is only available if FREQUENCY was selected in the OPERATING MODE function (→ 30). ACTIVE/POSITIVE and ACTIVE/NEGATIVE option: only available for flexible-assignment I/O boards with corresponding submodules (see Operating Instructions BA00111D)</p> <p>Description Use this function to select the output configurations of the frequency output.</p> <p>Options 0 = PASSIVE/POSITIVE 1 = PASSIVE/NEGATIVE 2 = ACTIVE/POSITIVE 3 = ACTIVE/NEGATIVE</p> <p>Factory setting PASSIVE/POSITIVE</p> <p>Explanation PASSIVE: external power supply for providing power to the output ACTIVE: device-internal power supply for providing power to the output Configuring the output signal level (POSITIVE or NEGATIVE) determines the quiescent behavior (at zero flow or minimum temperature) of the frequency output. The internal transistor is activated as follows:</p> <ul style="list-style-type: none"> ■ If POSITIVE is selected, the internal transistor is activated with a positive signal level ■ If NEGATIVE is selected, the internal transistor is activated with a negative signal level (0 V) <p> Note! With the passive output configuration, the output signal levels of the frequency output depend on the external circuit (see examples). (Continued on next page)</p>

Function description, PULSE, FREQUENCY, STATUS group

OUTPUT SIGNAL
(continued)

Example for passive output circuit (PASSIVE)

If PASSIVE is selected, the frequency output is configured as an open collector.

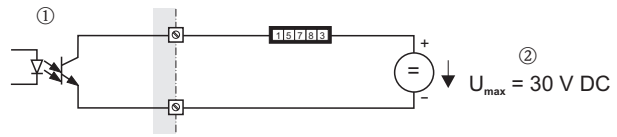

A0001225

1 = Open collector, 2 = External power supply

Note!

For continuous currents up to 25 mA ($I_{max} = 250 \text{ mA} / 20 \text{ ms}$).

Example for PASSIVE-POSITIVE output configuration

Output configuration with an external pull-up resistor. In the quiescent state (at zero flow), the output signal level at the terminals is 0 V.

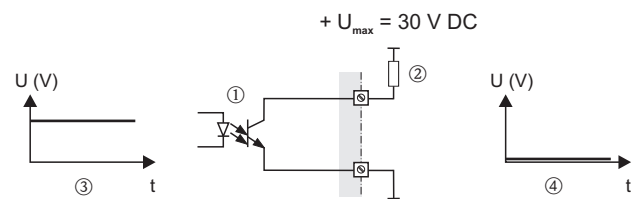

A0004687

1 = Open collector, 2 = Pull-up resistor,
3 = Transistor activation in "POSITIVE" quiescent state (at zero flow)
4 = Output signal level in quiescent state (at zero flow)

In the operating status (flow present), the output signal level changes from 0 V to a positive voltage level.

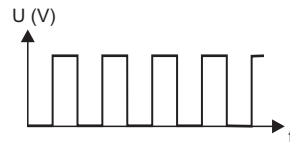

A0001975

Example for PASSIVE-POSITIVE output configuration:

Output configuration with an external pull-down resistor. In the quiescent state (at zero flow), a positive voltage level is measured via the pull-down resistor.

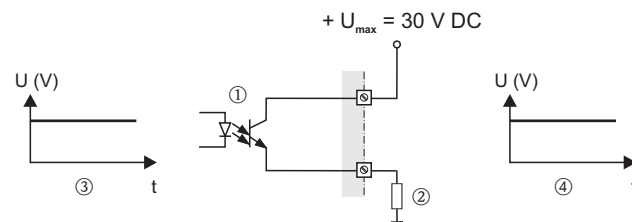

A0004689

1 = Open collector, 2 = Pull-down resistor,
3 = Transistor activation in "POSITIVE" quiescent state (at zero flow)
4 = Output signal level in quiescent state (at zero flow)

In the operating status (flow present), the output signal level changes from a positive voltage level to 0 V.

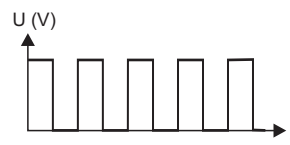







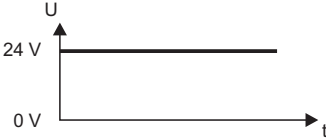
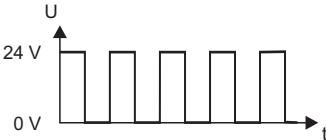





A0001981

(Continued on next page)

Function description, PULSE, FREQUENCY, STATUS group	
<p>OUTPUT SIGNAL (continued)</p>	<p>Example for PASSIVE-NEGATIVE output configuration: Output configuration with an external pull-up resistor. In the quiescent state (at zero flow), the output signal level at the terminals is at a positive voltage level.</p> <div style="text-align: center;"> </div> <div style="display: flex; justify-content: space-around;"> <div style="text-align: center;"> <p>③</p> </div> <div style="text-align: center;"> <p>④</p> </div> </div> <p style="text-align: right; font-size: small;">A0004690</p> <p><i>1 = Open collector, 2 = Pull-up resistor, 3 = Transistor activation in "NEGATIVE" quiescent state (at zero flow) 4 = Output signal level in quiescent state (at zero flow)</i></p> <p>In the operating status (flow present), the output signal level changes from a positive voltage level to 0 V.</p> <div style="text-align: center;"> </div> <p style="text-align: right; font-size: small;">A0001981</p> <p>Example for passive output circuit (ACTIVE) With an active circuit, the internal power supply is 24 V. The frequency output is short-circuit proof.</p> <div style="text-align: center;"> </div> <p style="text-align: right; font-size: small;">A0004691</p> <p><i>1 = 24 V DC internal power supply, 2 = Short-circuit proof output</i></p> <p>The signal levels are to be seen as analogous to the passive circuit. The following applies for the ACTIVE/POSITIVE output configuration: In the quiescent state (at zero flow), the output signal level at the terminals is 0 V.</p> <div style="text-align: center;"> </div> <p style="text-align: right; font-size: small;">A0004694</p> <p>In the operating status (flow present), the output signal level changes from 0 V to a positive voltage level.</p> <div style="text-align: center;"> </div> <p style="text-align: right; font-size: small;">A0004692</p> <p>(Continued on next page)</p>

Function description, PULSE, FREQUENCY, STATUS group	
<p>OUTPUT SIGNAL (continued)</p>	<p>The following applies for the ACTIVE/NEGATIVE output configuration: In the quiescent state (at zero flow), the output signal level at the terminals is at a positive voltage level.</p>  <p style="text-align: right; font-size: small;">A0004693</p> <p>In the operating status (flow present), the output signal level changes from a positive voltage level to 0 V.</p>  <p style="text-align: right; font-size: small;">A0004710</p>
<p>TIME CONSTANT</p>	<p>Prerequisite This function is only available if the FREQUENCY option was selected in the OPERATING MODE function (→ 30).</p> <p>Description Depending on the value entered for the time constant, you specify how the frequency output signal reacts to severely fluctuating measured variables, either very quickly (enter a low time constant) or with damping (enter a high time constant).</p> <p>User input Floating-point number 0.0 to 100.0 s</p> <p>Factory setting 0.0 s</p>
<p>FAILSAFE MODE</p>	<p>Prerequisite This function is only available if FREQUENCY was selected in the OPERATING MODE function (→ 30).</p> <p>Description Use this function to determine how the frequency output reacts in the event of a fault. The dictates of safety render it advisable to ensure that the frequency output assumes a predefined state in the event of a fault. The setting you select here affects only the frequency output. It has no effect on other outputs or the display (e.g. totalizers).</p> <p>Options</p> <p>FALLBACK VALUE 0 Hz output.</p> <p>FAILSAFE VALUE The frequency specified in the FAILSAFE VALUE function (→ 36) is output.</p> <p>HOLD VALUE Measured value output is based on the last measured value saved before the error occurred.</p> <p>ACTUAL VALUE Measured value output is based on the current flow measurement. The fault is ignored.</p> <p>Factory setting FALLBACK VALUE</p>

Function description, PULSE, FREQUENCY, STATUS group	
FAILSAFE VALUE	<p>Prerequisite This function is only available if FREQUENCY was selected in the OPERATING MODE function (→  30) and FAILSAFE VALUE in the FAILSAFE MODE function (→  35).</p> <p>Description Use this function to enter the frequency that the measuring device outputs in the event of an error.</p> <p>Display: Max. 4-digit number: 0 to 1250 Hz</p> <p>Factory setting 1250 Hz</p>
ACTUAL FREQUENCY	<p>Prerequisite This function is only available if FREQUENCY was selected in the OPERATING MODE function (→  30).</p> <p>Description The computed actual value of the output frequency appears on the display.</p> <p>Display 0 to 1250 Hz</p>
SIMULATION FREQUENCY	<p>Prerequisite This function is only available if FREQUENCY was selected in the OPERATING MODE function (→  30).</p> <p>Description Use this function to simulate the frequency output.</p> <ul style="list-style-type: none"> ▪ Notice message #621 "SIMULATION FREQUENCY OUTPUT" indicates that simulation is active. ▪ The measuring device continues to measure while simulation is in progress i.e. the current measured values are output correctly via the other outputs. <p> Note! The setting is not saved if the power supply fails.</p> <p>Options OFF ON</p> <p>Factory setting OFF</p>
VALUE SIMULATION FREQUENCY	<p>Prerequisite This function is only available if FREQUENCY was selected in the OPERATING MODE function (→  30) and ON in the SIMULATION FREQUENCY function (→  36).</p> <p>Description Use this function to define an arbitrary value (e.g. 500 Hz) which should be output at the frequency output. This value is used to test downstream devices and the measuring device itself.</p> <p>When you exit the function and the SIMULATION FREQUENCY function is activated (= ON), the message "END SIMULATION?" appears on the display. If you select YES, the simulation is terminated. If you select NO, the simulation is continued.</p> <p> Note! The setting is not saved if the power supply fails.</p> <p>User input 0 to 1250 Hz</p> <p>Factory setting 0 Hz</p>

Function description, PULSE, FREQUENCY, STATUS group	
ASSIGN PULSE	<p>Prerequisite This function is only available if PULSE was selected in the OPERATING MODE function (→  30).</p> <p>Description Use this function to assign a measured variable to the pulse output. If you select OFF, the only function shown in this function group is the ASSIGN PULSE function.</p> <p>Options OFF MASS FLOW CORRECTED VOLUME FLOW TEMPERATURE HEAT FLOW</p> <p>Factory setting MASS FLOW</p>
ASSIGN GAS GROUP	<p>Description Use this function to assign a gas group to a pulse output. If GAS GROUP 1&2 is selected, the individual values of each gas group are assigned to pulse output.</p> <p>Options: GAS GROUP 1 GAS GROUP 2 GAS GROUP 1&2</p> <p>Factory setting GAS GROUP 1</p>
PULSE VALUE	<p>Prerequisite This function is only available if PULSE was selected in the OPERATING MODE function (→  30).</p> <p>Description Use this function to define the flow rate at which a pulse is output. These pulses can be totaled by an external totalizer and the total flow since measuring started can be recorded in this way. The unit is taken from the SYSTEM UNITS group (→  9).</p> <p>User input 5-digit floating-point number</p> <p>Factory setting (country dependent →  79 and nominal diameter) [kg or lb]/pulse or [kWh or kBtu]/pulse)</p>

Function description, PULSE, FREQUENCY, STATUS group	
PULSE WIDTH	<p>Prerequisite This function is only available if PULSE was selected in the OPERATING MODE function (→ 30).</p> <p>Description Use this function to enter the pulse width of the output pulses.</p> <p>When entering the pulse width, select a value that can still be processed by an external totalizer (e.g. mechanical totalizer, PLC, etc.).</p> <p>If the selected pulse width cannot be maintained (interval $P <$ pulse width B entered), a system error message is generated after approx. 5 seconds buffer time/ idling time: "#359 RANGE PULSE". The reason for not being able to maintain the pulse width could be that the pulse number or frequency, which result from the pulse value entered (PULSE VALUE function → 37) and the actual flow, is too large.</p> <p>Pulses are always generated with the pulse width (B) entered in this function. The intervals (P) between the individual pulses are automatically configured. However, they must at least correspond to the pulse width ($B = P$).</p> <div style="display: flex; justify-content: space-around; align-items: flex-start;"> <div style="text-align: center;"> <p>Transistor</p> </div> <div style="text-align: center;"> <p>Transistor</p> </div> </div> <p style="text-align: right; font-size: small;">A0001233-en</p> <p><i>B = Pulse width entered (the illustration applies to positive pulses)</i> <i>P = Intervals between the individual pulses</i></p> <p>User input 0.5 to 2000 ms</p> <p>Factory setting 20 ms</p>

Function description, PULSE, FREQUENCY, STATUS group	
OUTPUT SIGNAL	<p>Prerequisite This function is only available if the PULSE option was selected in the OPERATING MODE function (→ 30). ACTIVE/POSITIVE and ACTIVE/NEGATIVE option: only available for flexible-assignment I/O boards with corresponding submodules (see Operating Instructions BA00111D)</p> <p>Description Use this function to select the output configuration of the pulse output.</p> <p>Options 0 = PASSIVE/POSITIVE 1 = PASSIVE/NEGATIVE 2 = ACTIVE/POSITIVE 3 = ACTIVE/NEGATIVE</p> <p>Factory setting PASSIVE/POSITIVE</p> <p>Explanation PASSIVE: external power supply for providing power to the output ACTIVE: device-internal power supply for providing power to the output</p> <p>Configuring the output signal level (POSITIVE or NEGATIVE) determines the quiescent behavior (at zero flow or minimum temperature) of the pulse output. The internal transistor is activated as follows:</p> <ul style="list-style-type: none"> ■ If POSITIVE is selected, the internal transistor is activated with a positive signal level ■ If NEGATIVE is selected, the internal transistor is activated with a negative signal level (0 V) <p> Note! With the passive output configuration, the output signal levels of the pulse output depend on the external circuit (see examples).</p> <p>(Continued on next page)</p>

Function description, PULSE, FREQUENCY, STATUS group

OUTPUT SIGNAL
(continued)

Example for passive output circuit (PASSIVE)

If PASSIVE is selected, the pulse output is configured as an open collector.

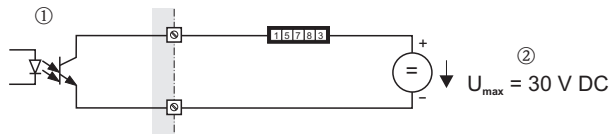

A0001225

1 = Open collector, 2 = External power supply

Note!

For continuous currents up to 25 mA ($I_{max} = 250 \text{ mA} / 20 \text{ ms}$).

Example for PASSIVE-POSITIVE output configuration

Output configuration with an external pull-up resistor. In the quiescent state (at zero flow), the output signal level at the terminals is 0 V.

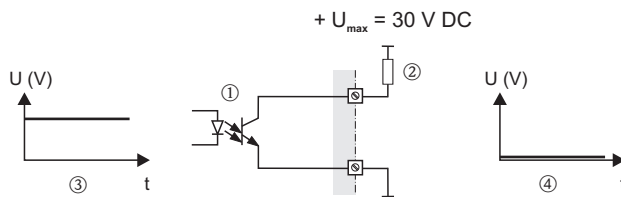

A0004687

1 = Open collector, 2 = Pull-up resistor,
3 = Transistor activation in "POSITIVE" quiescent state (at zero flow)
4 = Output signal level in quiescent state (at zero flow)

In the operating status (flow present), the output signal level changes from 0 V to a positive voltage level.

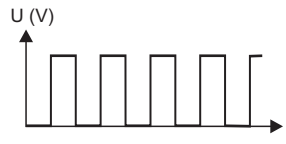

A0001975

Example for PASSIVE-POSITIVE output configuration:

Output configuration with an external pull-down resistor. In the quiescent state (at zero flow), a positive voltage level is measured via the pull-down resistor.

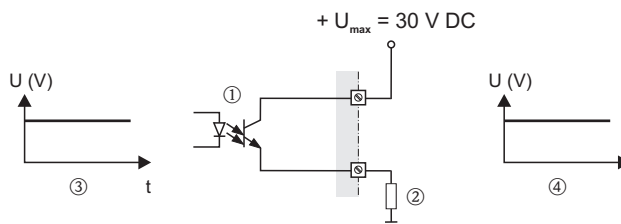

A0004689

1 = Open collector, 2 = Pull-down resistor,
3 = Transistor activation in "POSITIVE" quiescent state (at zero flow)
4 = Output signal level in quiescent state (at zero flow)

In the operating status (flow present), the output signal level changes from a positive voltage level to 0 V.

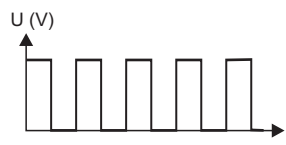







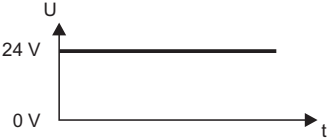
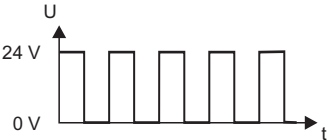



A0001981

(Continued on next page)





Function description, PULSE, FREQUENCY, STATUS group	
<p>OUTPUT SIGNAL (continued)</p>	<p>Example for PASSIVE-NEGATIVE output configuration: Output configuration with an external pull-up resistor. In the quiescent state (at zero flow), the output signal level at the terminals is at a positive voltage level.</p> <div style="text-align: center;"> </div> <p style="text-align: right; font-size: small;">A0004690</p> <p>In the operating status (flow present), the output signal level changes from a positive voltage level to 0 V.</p> <div style="text-align: center;"> </div> <p style="text-align: right; font-size: small;">A0001981</p> <p>Example for passive output circuit (ACTIVE) With an active circuit, the internal power supply is 24 V. The pulse output is short-circuit proof.</p> <div style="text-align: center;"> </div> <p style="text-align: right; font-size: small;">A0004691</p> <p>1 = 24 V DC internal power supply, 2 = Short-circuit proof output</p> <p>The signal levels are to be seen as analogous to the passive circuit. The following applies for the ACTIVE/POSITIVE output configuration: In the quiescent state (at zero flow), the output signal level at the terminals is 0 V.</p> <div style="text-align: center;"> </div> <p style="text-align: right; font-size: small;">A0004694</p> <p>In the operating status (flow present), the output signal level changes from 0 V to a positive voltage level.</p> <div style="text-align: center;"> </div> <p style="text-align: right; font-size: small;">A0004692</p> <p>(Continued on next page)</p>

Function description, PULSE, FREQUENCY, STATUS group	
<p>OUTPUT SIGNAL (continued)</p>	<p>The following applies for the ACTIVE/NEGATIVE output configuration: In the quiescent state (at zero flow), the output signal level at the terminals is at a positive voltage level.</p>  <p style="text-align: right; font-size: small;">A0004693</p> <p>In the operating status (flow present), the output signal level changes from a positive voltage level to 0 V.</p>  <p style="text-align: right; font-size: small;">A0004710</p>
<p>FAILSAFE MODE</p>	<p>Prerequisite This function is only available if PULSE was selected in the OPERATING MODE function (→ 30).</p> <p>Description The dictates of safety render it advisable to ensure that the pulse output assumes a predefined state in the event of a fault. Use this function to define this state. The setting you select here affects only the pulse output. It has no effect on other outputs or the display (e.g. totalizers).</p> <p>Options</p> <p>FALLBACK VALUE 0 pulse output.</p> <p>ACTUAL VALUE Measured value output is based on the current flow measurement. The fault is ignored.</p> <p>Factory setting FALLBACK VALUE</p>

Function description, PULSE, FREQUENCY, STATUS group	
SIMULATION PULSE	<p>Prerequisite This function is only available if PULSE was selected in the OPERATING MODE function (→  30).</p> <p>Description Use this function to simulate the pulse output.</p> <ul style="list-style-type: none"> ▪ Notice message #631 “SIM. PULSE” indicates that simulation is active. ▪ The on/off ratio is 1:1 for both types of simulation. ▪ The measuring device continues to measure while simulation is in progress i.e. the measured values are output correctly via the other outputs. <p> Note! The setting is not saved if the power supply fails.</p> <p>Options</p> <p>OFF</p> <p>COUNTDOWN The pulses specified in the VALUE SIMULATION PULSE function (→  43) are output.</p> <p>CONTINUOUSLY Pulses are continuously output with the pulse width specified in the PULSE WIDTH function (→  38). Simulation is started once the CONTINUOUSLY option is confirmed with the F key.</p> <p> Note! Simulation is started by confirming the CONTINUOUSLY option with the  key. Simulation can be switched off via the SIMULATION PULSE function.</p> <p>Factory setting OFF</p>
VALUE SIMULATION PULSE	<p>Prerequisite This function is only available if COUNTDOWN was selected in the SIMULATION PULSE function (→  43).</p> <p>Description Use this function to specify the number of pulses (e.g. 50) which are output during the simulation. This value is used to test downstream devices and the measuring device itself. The pulses are output with the pulse width specified in the PULSE WIDTH function (→  38). The on/off ratio is 1:1. Simulation is started once the specified value is confirmed with the F key. The display remains at 0 if the specified pulses have been transmitted. When you exit the function and the SIMULATION PULSE function (→  43) is activated (ON selected), the message "END SIMULATION?" appears on the display. If you select YES, the simulation is terminated. If you select NO, the simulation is continued.</p> <p> Note! The setting is not saved if the power supply fails.</p> <p>User input 0 to 10 000</p> <p>Factory setting 0</p>

Function description, PULSE, FREQUENCY, STATUS group	
ASSIGN STATUS	<p>Prerequisite This function is only available...</p> <ul style="list-style-type: none"> for flexible-assignment I/O boards with corresponding submodules (see Operating Instructions BA00111D) and if STATUS was selected in the OPERATING MODE function (→ 30). <p>Description Use this function to assign a switching function to the status output.</p> <ul style="list-style-type: none"> The status output displays quiescent current behavior, in other words the output is closed (transistor conductive) when normal, error-free operation is in progress. The switching behavior corresponds to the relay output (→ 50). If you select OFF, the only function shown in this function group is the ASSIGN STATUS function. <p>Options OFF ON (operation) FAULT MESSAGE NOTICE MESSAGE FAULT MESSAGE & NOTICE MESSAGE MASS FLOW LIMIT VALUE CORRECTED VOLUME FLOW LIMIT VALUE TEMPERATURE LIMIT VALUE TOTALIZER 1 LIMIT VALUE TOTALIZER 2 LIMIT VALUE HEAT FLOW LIMIT VALUE</p> <p>Factory setting FAULT MESSAGE</p>
SWITCH-ON POINT	<p>Prerequisite This function is only available...</p> <ul style="list-style-type: none"> if STATUS was selected in the OPERATING MODE function (→ 30) and if a limit value was selected in the ASSIGN STATUS function (→ 44). <p>Description Use this function to assign a value to the switch-on point (status output conductive). The value can be greater or smaller than the switch-off point. Negative values are only permitted for the TEMPERATURE measured variable. The unit is taken from the SYSTEM UNITS group (→ 9).</p> <p>User input 5-digit floating-point number [unit]</p> <p>Factory setting Depends on the option selected in the ASSIGN STATUS function</p> <ul style="list-style-type: none"> If TEMPERATURE LIMIT VALUE was selected: 0 °C (32 °F) (converted to the selected UNIT TEMPERATURE) If MASS FLOW LIMIT VALUE was selected: 0 kg/h (0 lb/h) (converted to the selected UNIT MASS FLOW) If CORRECTED VOLUME FLOW LIMIT VALUE was selected: 0 Nm³/h (0 Sm³/h) (converted to the selected UNIT CORRECTED VOLUME FLOW) If HEAT FLOW LIMIT VALUE was selected: 0 kW (0 kBtu) (converted to the selected UNIT HEAT FLOW)

Function description, PULSE, FREQUENCY, STATUS group	
SWITCH-OFF POINT	<p>Prerequisite This function is only available...</p> <ul style="list-style-type: none"> ▪ if STATUS was selected in the OPERATING MODE function (→ 30) and ▪ if a limit value was selected in the ASSIGN STATUS function (→ 44). <p>Description Use this function to assign a value to the switch-on point (status output not conductive). The value can be greater or smaller than the switch-off point. Negative values are only permitted for the TEMPERATURE measured variable. The unit is taken from the SYSTEM UNITS group (→ 9).</p> <p>User input 5-digit floating-point number [unit]</p> <p>Factory setting Depends on the option selected in the ASSIGN STATUS function</p> <ul style="list-style-type: none"> - If TEMPERATURE LIMIT VALUE was selected: 0 °C (32 °F) (converted to the selected UNIT TEMPERATURE) - If MASS FLOW LIMIT VALUE was selected: 0 kg/h (0 lb/h) (converted to the selected UNIT MASS FLOW) - If CORRECTED VOLUME FLOW LIMIT VALUE was selected: 0 Nm³/h (0 Sm³/h) (converted to the selected UNIT CORRECTED VOLUME FLOW) - If HEAT FLOW LIMIT VALUE was selected: 0 kW (0 kBtu) (converted to the selected UNIT HEAT FLOW)
TIME CONSTANT	<p>Prerequisite This function is only available if the following option was selected in the ASSIGN STATUS function (→ 44):</p> <ul style="list-style-type: none"> ▪ MASS FLOW LIMIT VALUE ▪ CORRECTED VOLUME FLOW LIMIT VALUE ▪ HEAT FLOW LIMIT VALUE ▪ TEMPERATURE LIMIT VALUE <p>Description Depending on the value entered for the time constant, you specify how the measuring signal reacts to severely fluctuating measured variables, either very quickly (enter a low time constant) or with damping (enter a high time constant). The purpose of damping, therefore, is to prevent the status output changing state continuously in response to fluctuations in flow.</p> <p>User input 0.0 to 100.0 s</p> <p>Factory setting 0.0 s</p>
ACTUAL STATUS	<p>Prerequisite This function is only available if STATUS was selected in the OPERATING MODE function (→ 30).</p> <p>Description The current status of the status output appears on the display.</p> <p>Display NOT CONDUCTIVE CONDUCTIVE</p>





Function description, PULSE, FREQUENCY, STATUS group	
SIMULATION SWITCH POINT	<p>Prerequisite This function is only available if STATUS was selected in the OPERATING MODE function (→  30).</p> <p>Description Use this function to simulate the status output.</p> <ul style="list-style-type: none"> ▪ Notice message #641 "SIM. STATUS OUTPUT" indicates that simulation is active. ▪ The measuring device continues to measure while simulation is in progress i.e. the current measured values are output correctly via the other outputs. <p> Note! The setting is not saved if the power supply fails.</p> <p>Options OFF ON</p> <p>Factory setting OFF</p>
VALUE SIMULATION SWITCH POINT	<p>Prerequisite This function is only available if ON was selected in the SIMULATION SWITCH POINT function (→  46).</p> <p>Description Use this function to define the switching behavior of the status output during the simulation. This value is used to test downstream devices and the measuring device itself. Simulation is started once the specified value is confirmed with the  key. The display remains at 0 if the specified pulses have been transmitted. When you exit the function and the SIMULATION SWITCH POINT function is activated (= ON), the message "END SIMULATION?" appears on the display. If you select YES, the simulation is terminated. If you select NO, the simulation is continued.</p> <p> Note! The setting is not saved if the power supply fails.</p> <p>User input NOT CONDUCTIVE CONDUCTIVE</p> <p>Factory setting NOT CONDUCTIVE</p>

13 RELAY OUTPUT 1/2

13.1 Group RELAY OUTPUT 1/2

Function description, RELAY OUTPUT 1/2 group	
<p>ASSIGN RELAY</p>	<p>Description Use this function to assign a switching function to the relay output.</p> <ul style="list-style-type: none"> ▪ Observe the graphics and comply with the information on the switching behavior of the relay output (→ 50). ▪ It is advisable to configure at least one relay output as a fault output and define the outputs' response to error. ▪ The relay output is configured as a normally open contact by default. It can be reconfigured as a normally closed contact by means of a jumper on the relay module. (See Operating Instructions BA00111D/06) ▪ If you select OFF or ON, the only function shown in this function group is the ASSIGN RELAY function. <p>Options OFF ON (operation) FAULT MESSAGE NOTICE MESSAGE FAULT MESSAGE & NOTICE MESSAGE MASS FLOW LIMIT VALUE CORRECTED VOLUME FLOW LIMIT VALUE TEMPERATURE LIMIT VALUE TOTALIZER 1 LIMIT VALUE TOTALIZER 2 LIMIT VALUE HEAT FLOW LIMIT VALUE</p> <p>Factory setting FAULT MESSAGE</p>
<p>SWITCH-ON POINT</p>	<p>Prerequisite This function is only available if a limit value was selected in the ASSIGN RELAY function (→ 47).</p> <p>Description Use this function to assign a value to the switch-on point (relay output pulls up). The value can be greater or smaller than the switch-off point. Negative values are only permitted for the TEMPERATURE measured variable. The unit is taken from the SYSTEM UNITS group (→ 9).</p> <p>User input 5-digit floating-point number [unit]</p> <p>Factory setting Depends on the option selected in the ASSIGN STATUS function</p> <ul style="list-style-type: none"> - If TEMPERATURE LIMIT VALUE was selected: 100 °C (212 °F) (converted to the selected UNIT TEMPERATURE) - If MASS FLOW LIMIT VALUE was selected: 0 kg/h (0 lb/h) (converted to the selected UNIT MASS FLOW) - If CORRECTED VOLUME FLOW LIMIT VALUE was selected: 0 Nm³/h (0 Sm³/h) (converted to the selected UNIT CORRECTED VOLUME FLOW) - If HEAT FLOW LIMIT VALUE was selected: 0 kW (0 kBtu) (converted to the selected UNIT HEAT FLOW)

Function description, RELAY OUTPUT 1/2 group	
SWITCH-ON DELAY	<p>Prerequisite This function is only available if a limit value was selected in the ASSIGN RELAY function (→ 47).</p> <p>Description Use this function to define a delay (0 to 100 seconds) for relay pull-up (i.e. signal changes from 0 to 1). The delay starts when the limit value selected is reached. The relay output switches when the delay period has elapsed if the switch condition has been valid throughout the delay period.</p> <p>User input Fixed-point number 0.0 to 100.0 s</p> <p>Factory setting 0.0 S</p>
SWITCH-OFF POINT	<p>Prerequisite This function is only available if a limit value was selected in the ASSIGN RELAY function (→ 47).</p> <p>Description Use this function to assign a value to the switch-off point (status output not conductive). The value can be greater or smaller than the switch-off point. Negative values are only permitted for the TEMPERATURE measured variable. The unit is taken from the SYSTEM UNITS group (→ 9).</p> <p>User input 5-digit floating-point number [unit]</p> <p>Factory setting Depends on the option selected in the ASSIGN STATUS function <ul style="list-style-type: none"> - If TEMPERATURE LIMIT VALUE was selected: 100 °C (212 °F) (converted to the selected UNIT TEMPERATURE) - If MASS FLOW LIMIT VALUE was selected: 0 kg/h (0 lb/h) (converted to the selected UNIT MASS FLOW) - If CORRECTED VOLUME FLOW LIMIT VALUE was selected: 0 Nm³/h (0 Sm³/h) (converted to the selected UNIT CORRECTED VOLUME FLOW) - If HEAT FLOW LIMIT VALUE was selected: 0 kW (0 kBtu) (converted to the selected UNIT HEAT FLOW) </p>
SWITCH-OFF DELAY	<p>Prerequisite This function is only available if a limit value was selected in the ASSIGN RELAY function (→ 47).</p> <p>Description Use this function to define a delay (0 to 100 seconds) for relay dropout (i.e. signal changes from 1 to 0). The delay starts when the limit value selected is reached. The relay output switches when the delay period has elapsed if the switch condition has been valid throughout the delay period.</p> <p>User input Fixed-point number 0.0 to 100.0 s</p> <p>Factory setting 0.0 S</p>
TIME CONSTANT	<p>Description Depending on the value entered for the time constant, you specify how the measuring signal reacts to severely fluctuating measured variables, either very quickly (enter a low time constant) or with damping (enter a high time constant). The purpose of damping, therefore, is to prevent the relay output changing state continuously in response to fluctuations in flow.</p> <p>User input 0 to 100 s</p> <p>Factory setting 0 s</p>

Function description, RELAY OUTPUT 1/2 group	
ACTUAL STATUS RELAY	<p>Description</p> <p>Use this function to display the actual status of the relay output. A jumper on the contact side defines the relay output as a normally open (NO or make) or normally closed (NC or break) contact → see Operating Instructions BA00111D/06.</p> <p>Display</p> <p>BREAK CONT. OPEN BREAK CONT. CLOSED MAKE CONT. OPEN MAKE CONT. CLOSED</p>
SIMULATION SWITCH POINT	<p>Description</p> <p>Use this function to simulate the relay output.</p> <ul style="list-style-type: none"> ▪ Notice message #651 to 652 "SIM. RELAY OUTPUT" indicates that simulation is active. ▪ The measuring device continues to measure while simulation is in progress i.e. the current measured values are output correctly via the other outputs. <p> Note! The setting is not saved if the power supply fails.</p> <p>Options</p> <p>OFF ON</p> <p>Factory setting</p> <p>OFF</p>
VALUE SIMULATION SWITCH POINT	<p>Prerequisite</p> <p>This function is only available if ON was selected in the SIMULATION SWITCH POINT function (→  46).</p> <p>Description</p> <p>Use this function to define the switching status of the relay output during the simulation. This value is used to test downstream devices and the measuring device itself. The options available for selection depend on whether the relay output was configured as a make or break contact. Simulation is started once the specified value is confirmed with the  key. The display remains at 0 if the specified pulses have been transmitted. When you exit the function and the SIMULATION SWITCH POINT function is activated (= ON), the message "END SIMULATION?" appears on the display. If you select YES, the simulation is terminated. If you select NO, the simulation is continued.</p> <p> Note! The setting is not saved if the power supply fails.</p> <p>Options</p> <p>Relay output configured as a normally closed (breaker) contact: BREAK CONT. OPEN BREAK CONT. CLOSED</p> <p>Relay output configured as a normally open (maker) contact: MAKE CONT. OPEN MAKE CONT. CLOSED</p>

13.2 Information on the response of the relay output

General information

If you have configured the relay output for "LIMIT VALUE" (→ 47, ASSIGN RELAY function), you can specify the required switch points in the SWITCH-ON POINT (→ 47) and SWITCH-OFF POINT (→ 48) functions.

If the measured variable in question reaches these predefined values, the status output switches as shown in the illustrations below.

Relay output configured for limit value

The relay output switches as soon as the current measured variable undershoots or overshoots a defined switch point.

Application: monitoring flow or process-related boundary conditions.

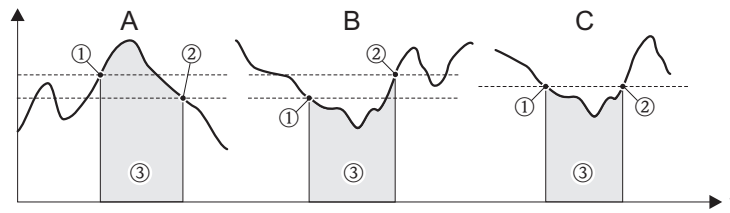







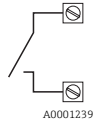
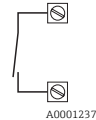

A0001235

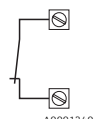
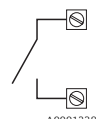
- m $ON \leq SWITCH-OFF POINT$ (maximum safety)
- n $ON > SWITCH-OFF POINT$ (minimum safety)
- o Status output switched off (not conductive)

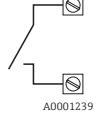
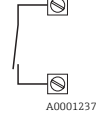

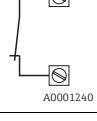
Switching behavior of the status output

Function	Status	Relay coil	Contact	
			NC contact	NO contact
ON (operation)	System in operation	energized 	 A0001239	 A0001237
	System not in operation (power supply failed)	de-energized 	 A0001240	 A0001238
Fault message	System OK	Conductive 	 A0001239	 A0001237
	(System or process error) Fault → failsafe mode of outputs/ inputs and totalizers	Not conductive 	 A0001240	 A0001238
Notice message	System OK	Conductive 	 A0001239	 A0001237
	(System or process error) Fault → continuation of operation	Not conductive 	 A0001240	 A0001238





Function	Status	Relay coil	Contact		
			NC contact	NO contact	
Fault message or notice message	System OK		Conductive	 A0001239	 A0001237
	(System or process error) Fault → failsafe mode or Notice → continuation of operation		Not conductive	 A0001240	 A0001238
Limit value <ul style="list-style-type: none"> ▪ Mass flow ▪ Corrected volume flow ▪ Temperature ▪ Totalizer ▪ Heat flow 	Limit value not overshoot or undershot		Conductive	 A0001239	 A0001237
	Limit value overshoot or undershot		Not conductive	 A0001240	 A0001238
<p> Note! If the measuring device has two relays, they are configured as follows at the factory:</p> <ul style="list-style-type: none"> ▪ Relay 1 → NO contact ▪ Relay 2 → NC contact 					



14 STATUS INPUT

Function description, STATUS INPUT group	
ASSIGN STATUS INPUT	<p>Description Use this function to assign a switching function to the status input.</p> <ul style="list-style-type: none"> Positive zero return is active as long as the level is present at the status input (continuous signal). All other assignments react to a change in level (pulse) at the status input. If you select OFF, the only function shown in this function group is the ASSIGN STATUS INPUT function. <p>Options OFF RESET TOTALIZER 1 POSITIVE ZERO RETURN ZERO POINT ADJUST RESET TOTALIZER 2 RESET ALL TOTALIZERS GAS GROUP</p> <p>Factory setting OFF</p>
ACTIVE LEVEL	<p>Description Use this function to define whether the assigned switching function (see ASSIGN STATUS INPUT function) is triggered or sustained when the signal level is present (HIGH) or not present (LOW).</p> <p>Options HIGH LOW</p> <p>Factory setting HIGH</p>
MINIMUM PULSE WIDTH	<p>Description Use this function to specify the minimum pulse width which the input pulse has to reach in order to trigger the selected switching function (ASSIGN STATUS INPUT function).</p> <p>Options 20 to 100 ms</p> <p>Factory setting 50 ms</p>
ACTUAL STATUS INPUT	<p>Description Use this function to view the current level of the status input.</p> <p>Display HIGH LOW</p>
SIMULATION STATUS INPUT	<p>Description Use this function to simulate the status input, i.e. to trigger the function assigned to the status input (see ASSIGN STATUS INPUT function (→ 52)).</p> <ul style="list-style-type: none"> Notice message #671 to 652 "SIM. STATUS INPUT" indicates that simulation is active. The measuring device continues to measure while simulation is in progress i.e. the current measured values are output correctly via the other outputs. <p> Note! The setting is not saved if the power supply fails.</p> <p>Options ON OFF</p> <p>Factory setting OFF</p>



Function description, STATUS INPUT group	
VALUE SIMULATION STATUS INPUT	<p>Prerequisite This function is only available if ON was selected in the SIMULATION STATUS INPUT function (→  52).</p> <p>Description Use this function to define the level to be assumed by the status input during simulation. This value is used to test downstream devices and the measuring device itself. When you exit the function and the SIMULATION SWITCH POINT function is activated (= ON), the message "END SIMULATION?" appears on the display. If you select YES, the simulation is terminated. If you select NO, the simulation is continued.</p> <p> Note! The setting is not saved if the power supply fails.</p> <p>Options HIGH LOW</p> <p>Factory setting LOW</p>

15 CURRENT INPUT

Function description, CURRENT INPUT group	
ASSIGN CURRENT INPUT	<p>Description Use this function to assign a process variable to the current input.</p> <ul style="list-style-type: none"> ▪ Select the PRESSURE option if an external pressure transmitter is being used to compensate the process pressure. ▪ Select the GAS ANALYZER option if a gas analyzer signal is used to automatically update the programmed gas mixture. ▪ If you select OFF, the only function shown in this function group is the ASSIGN CURRENT INPUT function. <p>Options OFF PRESSURE GAS ANALYZER</p> <p>Factory setting OFF</p>
CURRENT SPAN	<p>Description Use this function to select the current span. The option selected defines the operational range and the upper and lower signal on alarm. The HART option can also be defined for current output 1.</p> <p>Current span/operational range (measuring information): 0–20 mA / 0 to 20.5 mA 4–20 mA / 4 to 20.5 mA 4–20 mA NAMUR / 3.8 to 20.5 mA 4–20 mA US / 3.9 to 20.8 mA 0–20 mA (25 mA) / 0 to 24 mA 4–20 mA (25 mA) / 4 to 24 mA</p> <p> Note! When switching the hardware from an active (factory setting) to a passive output signal, select a current span of 4–20 mA (see Operating Instructions BA00111D/06)</p> <p>Options 0–20 mA 0–20 mA (25 mA) 4–20 mA 4–20 mA NAMUR 4–20 mA US 4–20 mA (25 mA)</p> <p>Factory setting 4–20 mA NAMUR (for all other current outputs)</p>
VALUE 0_4 mA	<p>Description Assign a value to the 4 mA current. The unit is taken from the function UNIT PRESSURE (→  12).</p> <p>User input 5-digit floating-point number</p> <p>Factory setting (Depends on the option selected in the ASSIGN CURRENT INPUT function) – PRESSURE: 0.0 [bar a] or 0.0 [psi a] (country dependent →  79) – GAS ANALYZER: 0.0%</p>
VALUE 20 mA	<p>Description Assign a value to the 20 mA current. The unit is taken from the function UNIT PRESSURE (→  12).</p> <p>User input 5-digit floating-point number</p> <p>Factory setting (Depends on the option selected in the ASSIGN CURRENT INPUT function) – PRESSURE: 21.000 [bar a] or 304.58 [psi a] (country dependent →  79) – GAS ANALYZER: 100.0%</p>



Function description, CURRENT INPUT group	
<p>FAILSAFE VALUE</p>	<p>Description Use this function to enter a defined error value for the process variable in question. Depends on the span selected in the CURRENT SPAN function. If the current value is outside of the selected range, the process variable is set to the "error value" defined here and notice message # 363 "CURRENT INPUT RANGE" is displayed.</p> <ul style="list-style-type: none"> ▪ The unit is taken from the function UNIT PRESSURE (→ 12). ▪ Triggered amplifier faults or the error behavior of the outputs do not affect the current input. <p>User input 5-digit floating-point number</p> <p>Factory setting (Depends on the option selected in the ASSIGN CURRENT INPUT function) - PRESSURE: 1.000 [bar a] or 14.504 [psi a] (country dependent → 79) - GAS ANALYZER: 0.0%</p>
<p>ACTUAL CURRENT INPUT</p>	<p>Description Use this function to view the actual value of the input current.</p> <p>Display: 0 to 25 mA</p>
<p>SIMULATION CURRENT INPUT</p>	<p>Description Use this function to activate simulation of the current input.</p> <ul style="list-style-type: none"> ▪ Notice message #661 "SIMULATION CURRENT INPUT" indicates that simulation is active. ▪ The value output for the simulation at the current input is defined in the VALUE SIMULATION CURRENT INPUT function. ▪ The measuring device continues to measure while simulation is in progress, i.e. the current measured values are output correctly via the other outputs and the display. <p> Note! The setting is not saved if the power supply fails.</p> <p>Options OFF ON</p> <p>Factory setting OFF</p>
<p>VALUE SIMULATION CURRENT INPUT</p>	<p>Prerequisite This function is only available if ON was selected in the SIMULATION CURRENT INPUT function (→ 52).</p> <p>Description Use this function to define the level to be assumed by the status input during simulation. This value is used to test downstream devices and the measuring device itself. When you exit the function and the SIMULATION CURRENT INPUT function is activated (= ON), the message "END SIMULATION?" appears on the display. If you select YES, the simulation is terminated. If you select NO, the simulation is continued.</p> <p> Note! The setting is not saved if the power supply fails.</p> <p>Options 0.00 to 25.00 mA</p> <p>Factory setting (Depending on the setting in the function CURRENT SPAN → 54) 0.00 to 25.00 mA</p>

16 COMMUNICATION



Function description, COMMUNICATION group	
TAG NAME	<p>Description Use this function to enter a tag name for the measuring device. You can edit and read this tag name via the local display or the HART protocol</p> <p>User input Max. 8-character text, permitted characters are: A-Z, 0-9, +, -, punctuation marks</p> <p>Factory setting "- - - - -" (no text)</p>
TAG DESCRIPTION	<p>Description Use this function to enter a tag description for the measuring device. You can edit and read this tag description via the local display or the HART protocol.</p> <p>User input Max. 16-character text, permitted characters are: A-Z, 0-9, +, -, punctuation marks</p> <p>Factory setting "- - - - -" (no text)</p>
FIELD BUS ADDRESS	<p>Description Use this function to define an address for the exchange of data with the HART protocol. A constant 4 mA current is applied with addresses 1 to 15.</p> <p>User input 0 to 15</p> <p>Factory setting 0</p>
HART PROTOCOL	<p>Description Information as to whether the HART protocol is active appears on the display.</p> <p> Note! The HART protocol is activated by choosing 4-20 mA HART or 4-20 mA (25 mA) HART in the CURRENT SPAN function (→  54).</p> <p>Display: OFF = HART protocol not active ON = HART protocol active</p> <p>Factory setting OFF</p>
WRITE PROTECTION	<p>Description Use this function to check whether the measuring device can be write-accessed. Write protection is activated and deactivated by means of a jumper on the I/O module (see Operating Instructions BA00111D/06).</p> <p>Display: OFF = Data exchange is possible ON = Data exchange disabled</p> <p>Factory setting OFF</p>
MANUFACTURER ID	<p>Description The manufacturer number in decimal numerical format appears on the display.</p> <p>Display: 17 = (11 hex) for Endress+Hauser</p>
DEVICE ID	<p>Description The instrument number in hexadecimal numerical format appears on the display.</p> <p>Display: 65 = (101 dec) for t-mass 65</p>

Function description, COMMUNICATION group	
DEVICE REVISION	<p>Description Use this function to view the device-specific revision of the HART command interface.</p> <p>Display: 1</p>

17 PROCESS PARAMETER

Function description, PROCESS PARAMETER group	
PROCESS PRESSURE 1	<p>Prerequisite This function is not available if the IN-SITU CALIBRATION function has been enabled. Refer to your Endress+Hauser sales center for more information.</p> <p>Description Use this function to enter the process pressure for GAS GROUP 1. (Selection and composition via the functions in the GAS 1/2 group) The unit is taken from the function UNIT PRESSURE (→ 12).</p> <p> Note! If an external pressure input is used via the ASSIGN CURRENT INPUT function group (→ 54), then this function operates as read only.</p> <p>Input/display 5-digit floating-point number</p> <p>Factory setting 1.0130 [bar a] or 14.692 [psi a] (country dependent → 79)</p>
PROCESS PRESSURE 2	<p>Prerequisite This function is not available if the IN-SITU CALIBRATION function has been enabled. Refer to your Endress+Hauser sales center for more information.</p> <p>Description Use this function to enter the process pressure for GAS GROUP 2. (Selection and composition via the functions in the GAS 1/2 group) The unit is taken from the function UNIT PRESSURE (→ 12).</p> <p> Note! If an external pressure input is used via the ASSIGN CURRENT INPUT function group (→ 54), then this function operates as read only.</p> <p>Input/display 5-digit floating-point number</p> <p>Factory setting 1.0130 [bar a] or 14.692 [psi a] (country dependent → 79)</p>
PROCESS PRESSURE	<p>Description Use this function to display the pressure value which is used for the flow calculation. The value is read from the following function:</p> <ul style="list-style-type: none"> ■ PROCESS PRESSURE 1 or 2 (depending on which gas group is active) or ■ ACTUAL CURRENT INPUT (if option is selected). <p> Note! The value from the CURRENT INPUT has priority over any value from PROCESS PRESSURE 1 or 2</p> <p>The unit is taken from the function UNIT PRESSURE (→ 12).</p> <p>Display 5-digit floating-point number</p> <p>Factory setting 1.0130 [bar a] or 14.692 [psi a] (country dependent → 79)</p>
REFERENCE PRESSURE	<p>Description Use this function to enter the reference pressure for calculating the reference density (for corrected volume flow measurement). The unit is taken from the function UNIT PRESSURE (→ 12).</p> <p>User input 5-digit floating-point number</p> <p>Factory setting 1.0130 [bar a] or 14.692 [psi a] (country dependent → 79)</p>

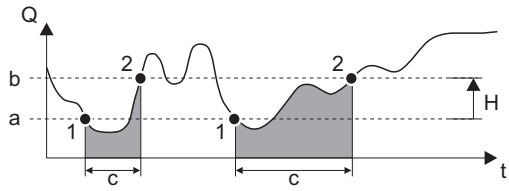
Function description, PROCESS PARAMETER group	
REFERENCE TEMPERATURE	<p>Description Use this function to enter the reference temperature for calculating the reference density (for corrected volume flow measurement). The unit is taken from the function UNIT TEMPERATURE (→ 12).</p> <p>User input 5-digit floating-point number</p> <p>Factory setting 0.0 [°C] or +32.0 [°F] (country dependent → 79.)</p>
REFERENCE DENSITY	<p>Prerequisite This function is not available if the IN-SITU CALIBRATION function has been enabled. Refer to your Endress+Hauser sales center for more information.</p> <p>Description Use this function to display the calculated reference density (for corrected volume flow measurement). The unit is taken from the function UNIT DENSITY (→ 13).</p> <p>Display 5-digit floating-point number</p>
NET CALORIFIC VALUE	<p>Prerequisite This function is only available if AUTO NET or MANUAL was selected in the MODE 1 or 2 function (→ 67)</p> <p>Description Use this function to display the current net calorific value of the gas. The unit is taken from the function UNIT CALORIFIC VALUE MASS (→ 10) or UNIT CALORIFIC VALUE CORRECTED VOLUME (→ 11).</p> <p>Display 5-digit floating-point number</p>
GROSS CALORIFIC VALUE	<p>Prerequisite This function is only available if AUTO GROSS was selected in the MODE 1 or 2 function (→ 67).</p> <p>Description Use this function to display the current gross calorific value of the gas. The unit is taken from the function UNIT CALORIFIC VALUE MASS (→ 10) or UNIT CALORIFIC VALUE CORRECTED VOLUME (→ 11).</p> <p>Display 5-digit floating-point number</p>
MOLE % GAS 1	<p>Prerequisite This function is not available if OFF was selected in the ANALYZER INPUT function (→ 63) of the active gas group.</p> <p>Description Use this function to display the mole % of GAS TYPE 1 (→ 64) in accordance with the input signal of the gas analyzer.</p> <p>Display 0.0 % to 100.0 %</p>
ASSIGN LOW FLOW CUT OFF	<p>Description For selecting the process variable on which low flow cut off should act.</p> <p>Options OFF MASS FLOW CORRECTED VOLUME FLOW</p> <p>Factory setting MASS FLOW</p>

Function description, PROCESS PARAMETER group	
<p>ON-VALUE LOW FLOW CUT OFF</p>	<p>Prerequisite This function is not available if OFF was selected in the ASSIGN LOW FLOW CUT OFF function (→ 59).</p> <p>Description Use this function to enter the on-value for low flow cut off. The unit is taken from the SYSTEM UNITS group (→ 9). Low flow cut off is switched on if the value entered is not equal to 0. An inverted plus sign is shown on the local display of the flow value as soon as the low flow cut off is active.</p> <p>User input 5-digit floating-point number</p> <p>Factory setting 1% of calibrated full scale value</p>
<p>OFF-VALUE LOW FLOW CUT OFF</p>	<p>Description Use this function to enter the off-value for low flow cut off. Enter the off-value as a positive hysteresis from the on-value.</p> <div style="text-align: center;">  <p>The graph plots flow rate Q on the vertical axis against time t on the horizontal axis. A fluctuating line represents the flow rate. Two horizontal dashed lines, labeled 'a' and 'b', represent the ON and OFF values for the low flow cutoff. Line 'a' is lower than line 'b'. The vertical distance between 'a' and 'b' is labeled 'H' for hysteresis. Two shaded regions under the curve, labeled 'c', indicate periods where the flow rate is between 'a' and 'b'. Points '1' and '2' are marked on the curve: '1' is at the point where the flow rate crosses line 'a' from above, and '2' is at the point where it crosses line 'b' from above.</p> </div> <p><small>A0001245</small></p> <p><i>Abb. 3: Example for the behavior of low flow cutoff</i></p> <p><i>Q</i> Flow rate [volume/time] <i>t</i> Time <i>H</i> Hysteresis <i>a</i> ON VALUE LOW FLOW CUT OFF = 20 kg/h <i>b</i> OFF-VALUE LOW FLOW CUTOFF = 10% <i>c</i> Low flow cutoff active <i>1</i> Low flow cut off is switched on at 20 kg/h <i>2</i> Low flow cut off is switched off at 22 kg/h</p> <p>User input Integer 0 to 100%</p> <p>Factory setting 50%</p>
<p>ZERO POINT ADJUST</p>	<p>Description Use this function to start automatic zero point adjustment.</p> <p> Caution! Prior to performing zero point adjustment, observe the exact procedure for zero point adjustment as specified in Operating Instructions BA00111D/06.</p> <p> Note!</p> <ul style="list-style-type: none"> ■ If zero point adjustment is not possible due to unstable flow conditions, alarm #451 "ADJUST ZERO FAIL" appears on the display. ■ RESET: reset to factory calibration. ■ Measuring devices with a status input: zero point adjustment can be started via the status input. <p>Options START CANCEL RESET</p> <p>Factory setting CANCEL</p>

Function description, PROCESS PARAMETER group	
INSTALLATION FACTOR	<p>Description Disturbances in the flow may arise due to the design of the system, such as pipe bends, reducers, etc. The flow value measured is scaled by entering a constant factor. The flow disturbance can thus be compensated using the calculated flow signal:</p> <p>Flow output = measured flow × installation factor</p> <p>Enter a higher value: flow value output is increased. Enter a lower value: flow value output is decreased.</p> <p>User input 5-digit floating-point number 0.0000 to 99999</p> <p>Factory setting 1.0000</p>

18 GAS



Function description, GAS group

Prerequisite

This function is **not** available if the IN-SITU CALIBRATION function is enabled. This function is available again if the in-situ calibration is reset to the factory setting. Contact your Endress+Hauser service organization for more information.

Description

Use this function to view or change the gas configuration

- The device can be configured with one or two independent gas groups.
- Switching between two groups can be performed digitally (ASSIGN STATUS INPUT (→  52)) or manually (SELECT GROUP (→  63)).
- Gas mixtures, such as natural gas, can be automatically updated via a gas analyzer signal. Assignment is performed in the CURRENT INPUT function group (→  54).

General programming rules:

- A gas group can be configured with 1 single gas or a gas mixture (max. 8 gas constituents).
- The sum of the gas mixture constituents entered must total 100.0 Mole %.
- A gas constituent and its corresponding Mole % can be entered in any order within the mixture.
- A gas constituent may have a value of 0.0 Mole % within the mixture.
- The option NOT USED in the GAS TYPE 1 and GAS TYPE 2 to 8 functions is a place holder where no gas is assigned. The program does not use this option for calculations.
- The option SPECIAL GAS is a substitute for other gases. The Mole % value is always 100.0%

 Note!

For a flowchart of the GAS QUICK SETUP, see Operating Instructions BA00111D/06.

Programming examples

a. 1 gas group: 1 standard gas

SELECT GROUP	GAS GROUP 1
ANALYZER INPUT	OFF
NUMBER OF GASES	1
GAS TYPE 1	AIR
MOLE % GAS 1	100.0 %

b. 2 gas groups: 2 standard gases

SELECT GROUP	GAS GROUP 1	GAS GROUP 2
ANALYZER INPUT	OFF	OFF
NUMBER OF GASES	1	1
GAS TYPE 1	ARGON	NITROGEN
MOLE % GAS 1	100.0 %	100.0 %





c. 2 gas groups: 1 standard gas, 1 special gas

SELECT GROUP	GAS GROUP 1	GAS GROUP 2
ANALYZER INPUT	OFF	OFF
NUMBER OF GASES	1	1
GAS TYPE 1	OXYGEN	SPECIAL GAS
MOLE % GAS 1	100.0 %	100.0 %
DESCRIPTION	-	O2 90% OZONE 10%
CORRECTION FACTOR	-	1.2009
REFERENCE DENSITY	-	1.5005 kg/m ³

d. 1 gas groups: 1 gas mixture (with gas analyzer input compensation)

SELECT GROUP	GAS GROUP 1
ANALYZER INPUT	ON
NUMBER OF GASES	1
GAS TYPE 1	METHANE
MOLE % GAS 1	50.0 %
GAS TYPE 2	CARBON DIOXIDE
MOLE % GAS 2	40.0 %
GAS TYPE 3	NITROGEN

MOLE % GAS 3	10.0 %
--------------	--------







Function description, GAS group	
SELECT GROUP	<p>Description</p> <ul style="list-style-type: none"> select a gas group for editing set the active gas group manually <p>Setting the active gas group:</p> <ul style="list-style-type: none"> Once all the necessary settings have been programmed in the gas group, select YES in the SAVE CHANGES function (→  63), or If the gas group is already programmed as required, simply select the required gas group and then exit using the ESC keys (). <p> Note! If the STATUS INPUT STATUS INPUT is assigned to control switching of the gas groups, then the STATUS INPUT will over-ride the setting of this function.</p> <p>Options GAS GROUP 1 GAS GROUP 2</p> <p>Factory setting GAS GROUP 1</p>
ANALYZER INPUT	<p>Prerequisite The option GAS ANALYZER must be selected in the ASSIGN CURRENT INPUT function (→  54).</p> <p>Description Use this function to assign automatic updating of a gas group (via a gas analyzer signal and the current input function). A gas group must contain at least 2 gas types (e.g. Methane 60%, Carbon Dioxide 40%).</p> <p>User input OFF ON</p> <p>Factory setting OFF</p>
NUMBER OF GASES	<p>Description Use this function to enter the number of gases that are used in the gas group.</p> <p>User input 1 to 8</p> <p>Factory setting 1</p>



Function description, GAS group	
GAS TYPE 1	<p>Description Use this function to select gas type 1.</p> <p>Options AIR AMMONIA ARGON BUTANE CARBON DIOXIDE CARBON MONOXIDE CHLORINE ETHANE ETHYLENE HELIUM 4 HYDROGEN NORMAL HYDROGEN CHLORIDE HYDROGEN SULFIDE KRYPTON METHANE NEON NITROGEN OXYGEN PROPANE XENON NOT USED SPECIAL GAS</p> <p>Factory setting AIR</p>
MOLE % GAS 1	<p>Prerequisite This function is not available if the setting in NUMBER OF GASES (→ 63) is 1. (The factory setting 100% is automatically used)</p> <p>Description Use this function to enter the Mole % of the gas selected in GAS TYPE 1.</p> <p>User input 000.00 % to 100.00 %</p> <p>Factory setting 100.00 %</p>
DESCRIPTION	<p>Prerequisite This function is only available if the option SPECIAL GAS is selected in the function GAS TYPE 1 (→ 64).</p> <p>Description Use this function to enter a description for a special gas configuration.</p> <p>Example A special composition consisting of 93% oxygen and 7% ozone. User input: O2 93% OZONE 7%</p> <p>User input xxxx (max. 16 characters) Valid characters are A-Z, 0-9, +, -, decimal point, white space or underscore</p> <p>Factory setting "-----" (no text)</p>

Function description, GAS group	
CORRECTION FACTOR	<p>Prerequisite This function is only available if the option SPECIAL GAS is selected in the function GAS TYPE 1 (→ ☰ 64).</p> <p>Description Use this function to enter a manual correction factor for a special gas configuration. The correction factor is normally based on air and at the specified process conditions. The correction factor is determined by the factory. If the gas or process conditions change from the initial setting, then the correction factor value will also need updating.</p> <p>User input 5-digit floating-point number</p> <p>Factory setting 1.0</p>
REFERENCE DENSITY	<p>Prerequisite This function is only available if the option SPECIAL GAS is selected in the function GAS TYPE 1 (→ ☰ 64).</p> <p>Description Use this function to enter a reference density for a special gas configuration when corrected volume flow is required, e.g. Nm³ (Sft³) The unit is taken from the function UNIT DENSITY (→ ☰ 13). The reference density is determined by the factory. If the gas or reference conditions change from the initial setting, then the reference density value will also need updating.</p> <p>User input 5-digit floating-point number, with unit</p> <p>Factory setting 1.2930 [kg/m³] or 0.0807 [lb/ft³] (country dependent → ☰ 79)</p>
GAS TYPE 2 to 8	<p>Prerequisite The number of functions available here is dependent upon the setting in the function NUMBER OF GASES (→ ☰ 63).</p> <p>Description Use this function to select the gas type.</p> <p>Options AIR AMMONIA ARGON BUTANE CARBON DIOXIDE CARBON MONOXIDE CHLORINE ETHANE ETHYLENE HELIUM 4 HYDROGEN NORMAL HYDROGEN CHLORIDE HYDROGEN SULFIDE KRYPTON METHANE NEON NITROGEN OXYGEN PROPANE XENON NOT USED</p> <p>Factory setting NOT USED</p>

Function description, GAS group	
MOLE % GAS 2 to 8	<p>Prerequisite The number of functions available here is dependent upon the setting in the function NUMBER OF GASES (→ 63).</p> <p>Description Use this function to enter the Mole % of the gas selected in GAS TYPE 2 to 8.</p> <p>User input 000.00 % to 100.00 %</p> <p>Factory setting 100.00 %</p>
CHECK VALUES	<p>Prerequisite This function is only available if there is an error in the Mole % values.</p> <p>Description The error message MIXTURE NOT 100% appears if the entered values do not add up to 100%. The entries have to be checked and corrected before the gas group can be saved and used for flow measurement (see option YES® function SAVE CHANGES (→ 66)).</p> <p>Display MIXTURE NOT 100%</p>
SAVE CHANGES	<p>Description Use this function to control the way entries are saved in the gas group and utilized for flow measurement.</p> <p>Options</p> <p>CANCEL The entered parameters are saved in the gas group but they are not used for flow measurement. The gas group can be activated, at a later time, by returning to the group, checking the parameters and then selecting the option YES in this function.</p> <p>YES The entered parameters are saved in the gas group and are used for flow measurement.</p> <p>DISCARD The entered parameters are not saved. The previous parameters remain valid and are used for flow measurement.</p>

19 HEAT FLOW





Function description, HEAT FLOW group	
CALORIFIC VALUE TYPE	<p>Description Use this function to select the measured variable on which the combustion value is based.</p> <p>Options</p> <ul style="list-style-type: none"> ▪ MASS ▪ CORRECTED VOLUME <p>Factory setting MASS</p>
MODE 1	<p>Description Use this function to select a mode for calculating the heat flow (GAS GROUP 1).</p> <p>Options</p> <ul style="list-style-type: none"> ▪ AUTO NET ▪ AUTO GROSS ▪ MANUAL <p>Factory setting AUTO NET</p>
HEATING VALUE 1	<p>Prerequisite This function is only available if MANUAL was selected in the MODE 1 function (→  67).</p> <p>Description Use this function to enter a user-specific calorific value.</p> <p>Input/display 5-digit floating-point number</p> <p>Factory setting 0.0 The corresponding unit is taken from the UNIT CALORIFIC VALUE MASS (→  10) or UNIT CALORIFIC VALUE CORRECTED VOLUME function (→  11).</p>
MODE 2	<p>Description Use this function to select a mode for calculating the heat flow (GAS GROUP 2).</p> <p>Options</p> <ul style="list-style-type: none"> ▪ AUTO NET ▪ AUTO GROSS ▪ MANUAL <p>Factory setting AUTO NET</p>
HEATING VALUE 2	<p>Prerequisite This function is only available if MANUAL was selected in the MODE 2 function (→  67).</p> <p>Description Use this function to enter a user-specific calorific value.</p> <p>Input/display 5-digit floating-point number</p> <p>Factory setting 0.0 The corresponding unit is taken from the UNIT CALORIFIC VALUE MASS (→  10) or UNIT CALORIFIC VALUE CORRECTED VOLUME function (→  11).</p>

















Function description, HEAT FLOW group	
REFERENCE COMBUSTION TEMPERATURE	<p>Prerequisite The function is not available if MANUAL was selected in the MODE 1 or 2 function (→  67) .</p> <p>Description Use this function to enter the reference combustion temperature of the gas. This function is used to calculate the calorific value of the gas. The unit is taken from the function UNIT TEMPERATURE (→  12).</p> <p>User input 5-digit floating-point number</p> <p>Factory setting 25.0 °C or 60.0 °F (country dependent →  79)</p>

20 SYSTEM PARAMETER

Function description, SYSTEM PARAMETER group	
POSITIVE ZERO RETURN	<p>Description Use this function to interrupt evaluation of measured variables. For example, the output signal should be set to zero flow during operations such as pipe cleaning.</p> <p>The setting acts on all functions and outputs of the measuring device. If the positive zero return is active, the notice message #601 "POSITIVE ZERO-RET" is displayed. If the transmitter is fitted with a status input, then the positive zero return function can be activated by the function ASSIGN STATUS INPUT (→ 52).</p> <p>Options OFF ON (signal output is set to zero flow value, temperature is as normal)</p> <p>Factory setting OFF</p>
FLOW DAMPING	<p>Description For setting the filter depth. The sensitivity of the flow measurement signal can be reduced with respect to transient flows and interference peaks. The response time of the measuring device increases with every increase in the filter setting.</p> <p>The damping acts prior to other damping functions (e. g. display, time constant).</p> <p>User input 0 to 100 s</p> <p>Factory setting 1 s</p>

21 SENSOR DATA

Function description, SENSOR DATA group	
<p>This group of functions contains the essential data relating to the sensor geometry and calibration.</p> <p>Flange version (t-mass 65 F): The sensor data cannot be changed and is read only.</p> <p>Insertion version (t-mass 65 I): The sensor data can be changed to suit the application pipe.</p> <p>The pipe or duct dimensions are essential for calculating the correct insertion depth.</p> <p> Note!</p> <p>To record the sensor data for the insertion sensor (t-mass 65I), see the flowchart of the QUICK SETUP SENSOR in Operating Instructions BA00111D/06.</p> <p>Refer to your Endress+Hauser sales center for more information.</p>	
PIPE TYPE	<p>Prerequisite This function is only available for insertion sensors (t-mass 65I).</p> <p>Description Use this function to select whether the insertion sensor is used in a circular or rectangular pipe.</p> <p>Options CIRCULAR RECTANGULAR</p> <p>Factory setting CIRCULAR</p>
PIPE STANDARD	<p>Prerequisite This function is only available for insertion sensors (t-mass 65I). This function is not available if RECTANGULAR is selected in the PIPE TYPE function (→  70).</p> <p>Description Use this function to select a pipe standard. If the option OTHERS is selected here, then values need to be entered in the functions OUTER DIAMETER/OUTER DIAMETER and WALL THICKNESS/WALL THICKNESS.</p> <p>Options DIN: PN6, PN10, PN25, PN40 ANSI: B36.10 SCHEDULE 10, 20, 30, 40, 60, 80 B36.19 SCHEDULE 10, 40, 80 OTHERS</p> <p>Factory setting PN10 or B36.10 SCHEDULE 10 (country dependent →  79)</p>
NOMINAL DIAMETER	<p>Prerequisite This function is only available for insertion sensors (t-mass 65I). This function is not available if OTHER was selected in the PIPE STANDARD function (→  70) or RECTANGULAR in the PIPE TYPE function (→  70).</p> <p>Description Use this function to select the nominal diameter of the pipe.</p> <p>Options 80/3", 100/4", 150/6", 200/8", 250/10", 300/12", 350/14", 400/16", 450/18", 500/20", 600/24", 700/28", 800/32", 900/36", 1000/40"</p> <p>Factory setting 150/6"</p>

Function description, SENSOR DATA group	
OUTER DIAMETER	<p>Prerequisite This function is only available for insertion sensors (t-mass 65I). This function is only available if CIRCULAR is selected in the PIPE TYPE function (→  70) and OTHER was selected in the PIPE STANDARD function (→  70).</p> <p>Description Use this function to enter the outer diameter of a circular pipe. The unit is taken from the function UNIT LENGTH (→  13).</p> <p>User input 5-digit floating-point number 60 to 99999 (mm) or 2.362 to 3937 (inch) (country dependent →  79)</p> <p>Factory setting 168.3 (mm) or 6.0 (inch) (country dependent →  79)</p>
WALL THICKNESS	<p>Prerequisite This function is only available for insertion sensors (t-mass 65I). This function is only available if OTHER was selected in the PIPE STANDARD function (→  70).</p> <p>Description Use this function to enter the wall thickness of a circular or rectangular duct. The unit is taken from the function UNIT LENGTH (→  13).</p> <p>User input 5-digit floating-point number 2.0 to 40.0 (mm) or 0.08 to 1.57 (inch) (country dependent →  79)</p> <p>Factory setting 4.5 (mm) or 0.1771 (inch) (country dependent →  79)</p>
INTERNAL DIAMETER	<p>Prerequisite This function is only available for insertion sensors (t-mass 65I). This function is only available if OTHER is selected in the PIPE STANDARD function (→  70) and CIRCULAR was selected in the PIPE TYPE function (→  70).</p> <p>Description Use this function to view the internal diameter of a circular pipe. The unit is taken from the function UNIT LENGTH (→  13).</p> <p>Display 5-digit floating-point number</p> <p>Factory setting Depends on the sensor size (country dependent →  79)</p>
INTERNAL HEIGHT	<p>Prerequisite This function is only available for insertion sensors (t-mass 65I). This function is only available if RECTANGULAR was selected in the PIPE TYPE function (→  70).</p> <p>Description Use this function to enter the internal height of a rectangular duct. The unit is taken from the function UNIT LENGTH (→  13).</p> <p>User input 5-digit floating-point number 45 to 99999 (mm) or 1.771 to 3937 (inch) (country dependent →  79)</p> <p>Factory setting 150.0 (mm) or 6.0 (inch) (country dependent →  79)</p>

Function description, SENSOR DATA group	
INTERNAL WIDTH	<p>Prerequisite This function is only available for insertion sensors (t-mass 65I). This function is only available if RECTANGULAR was selected in the PIPE TYPE function (→ 70).</p> <p>Description Use this function to enter the internal width of a rectangular duct. The unit is taken from the function UNIT LENGTH (→ 13).</p> <p>User input 5-digit floating-point number 45 to 99999 (mm) or 1.771 to 3937 (inch) (country dependent → 79)</p> <p>Factory setting 150.0 (mm) or 6.0 (inch) (country dependent → 79)</p>
MOUNTING	<p>Prerequisite This function is only available for insertion sensors (t-mass 65I). This function is only available if RECTANGULAR was selected in the PIPE TYPE function (→ 70).</p> <p>Description Use this function to select the installation direction of the insertion sensor in the rectangular duct.</p> <ul style="list-style-type: none"> - If the VERTICAL option is selected, the value from the function INTERNAL HEIGHT (→ 71) is used to calculate the insertion depth - If the HORIZONTAL option is selected, the value from the function INTERNAL WIDTH (→ 72) is used to calculate the insertion depth <p>Options HORIZONTAL VERTICAL</p> <p>Factory setting VERTICAL</p>
MOUNTING SET LENGTH	<p>Prerequisite This function is only available for insertion sensors (t-mass 65I).</p> <p>Description Use this function to enter a value for the length of the mounting set (including the sensor compression fitting). The unit is taken from the function UNIT LENGTH (→ 13).</p> <p>User input 5-digit floating-point number 75 to 900 (mm) or 2.953 to 35.433 (inch) (country dependent → 79)</p> <p>Factory setting 106.0 (mm) or 4.173 (inch) (country dependent → 79) The factory setting value is the length of the G1A compression fitting and standard Endress+Hauser mounting boss.</p>
INSERTION DEPTH	<p>Prerequisite This function is only available for insertion sensors (t-mass 65I).</p> <p>Description This function displays the calculated insertion depth for mounting the sensor. The unit is taken from the function UNIT LENGTH (→ 13). For more information on insertion depth calculation, please refer to the Operating Instructions BA00111D/06.</p> <p>Display 5-digit floating-point number</p>





Function description, SENSOR DATA group	
ZERO POINT	<p>Description This function shows the current zero point correction value for the sensor. The zero point is determined by the ZERO POINT ADJUST (→  60) function.</p> <p>User input 5-digit floating-point number -20.000 to +20.000</p> <p>Factory setting Depends on calibration.</p>
FLOW CONDITIONER	<p>Description Use this function to indicate if the t-mass 65F sensor has been calibrated with or without a flow conditioner.</p> <p>Display WITH WITHOUT</p> <p>Factory setting WITHOUT</p>
CALIBRATION DATE	<p>Description Use this function to display the date of the last factory calibration of the measuring device. This date is not updated by the IN-SITU CALIBRATION function.</p> <p>Options DD.MM.YYYY</p>

22 SUPERVISION

Function description, SUPERVISION group	
ACTUAL SYSTEM CONDITION	<p>Description The current system status appears on the display.</p> <p>Display SYSTEM OK or The fault/notice message with the highest priority.</p>
PREVIOUS SYSTEM CONDITION	<p>Description The last 16 fault and notice messages appear on the display.</p>
ASSIGN SYSTEM ERROR	<p>Description All system errors appear on the display. If you select an individual system error you can change its error category:</p> <ul style="list-style-type: none"> ▪ Each individual message can be selected using the + and - key. ▪ If the E key is pressed twice, the ERROR CATEGORY function is called up. ▪ Use the ESC key combination or select "CANCEL" (in the system error list) to exit the function. <p>Display List of system errors</p>
ERROR CATEGORY	<p>Description Use this function to define whether a system error triggers a notice message or a fault message. If you select FAULT MESSAGES, all outputs respond to an error in accordance with their defined failsafe mode.</p> <ul style="list-style-type: none"> ▪ Press the E key twice to call up the ASSIGN SYSTEM ERROR function (→ 74). ▪ Use the ESC key combination to exit the function. <p>Options NOTICE MESSAGES (display only) FAULT MESSAGE (outputs and display)</p>
ASSIGN PROCESS ERROR	<p>Description All process errors appear on the display. If you select an individual process error you can change its error category:</p> <ul style="list-style-type: none"> ▪ Each individual message can be selected using the + and - key. ▪ Press the E key twice to call up the ERROR CATEGORY function (→ 74). ▪ Use the ESC key combination or select "CANCEL" (in the process error list) to exit the function. <p>Display List of process errors</p>
ERROR CATEGORY	<p>Description Use this function to define whether a process error triggers a notice message or a fault message. If you select FAULT MESSAGES, all outputs respond to an error in accordance with their defined failsafe mode.</p> <ul style="list-style-type: none"> ▪ Press the E key twice to call up the ASSIGN PROCESS ERROR function (→ 74). ▪ Use the ESC key combination to exit the function. <p>Options NOTICE MESSAGES (display only) FAULT MESSAGE (outputs and display)</p>

Function description, SUPERVISION group	
ALARM DELAY	<p>Description Use this function to enter a time delay for which the criteria for an error always has to be satisfied before a fault or notice message is generated. Depending on the setting and the type of error, this suppression acts on the display, the current output, the frequency output and the status output.</p> <p> Note! If this function is used, fault and notice messages are delayed by the time corresponding to the setting before being forwarded to the higher-level controller (PLC, DCS, etc.). Therefore, check in advance whether a delay of this nature could affect the safety requirements of the process. If fault and notice messages are not be suppressed, than a value of 0 seconds must be entered here.</p> <p>User input 0 to 100 s (in steps of one second)</p> <p>Factory setting 0 s</p>
SYSTEM RESET	<p>Description Use this function to restart (reset) the measuring device.</p> <p>Options NO The device is not restarted. RESTART SYSTEM Restart without disconnecting main power. In doing so, all the data (functions) are accepted unchanged.</p> <p>Factory setting NO</p>
OPERATION HOURS	<p>Description The hours of operation of the device appear on the display.</p> <p>Display Depends on the number of hours of operation elapsed: Hours of operation < 10 hours → display format = 0:00:00 (hr:min:sec) Hours of operation 10 to 10 000 hours → display format = 0000:00 (hr:min) Hours of operation >10 000 hours → display format = 000000 (hr)</p>
HOURS SINCE RESET	<p>Description The hours of operation since the last reset of the device appear on the display.</p> <p>Display Depends on the number of hours of operation elapsed: Hours of operation < 10 hours → display format = 0:00:00 (hr:min:sec) Hours of operation 10 to 10 000 hours → display format = 0000:00 (hr:min) Hours of operation >10 000 hours → display format = 000000 (hr)</p>

23 SIMULATION SYSTEM

Function description, SIMULATION SYSTEM group	
SIMULATION FAILSAFE MODE	<p>Description Use this function to set all inputs, outputs and the totalizer to their error-response modes, in order to check whether they respond correctly. During this time, the message #691 "SIMULATION FAILSAFE" appears on the display.</p> <p>Options OFF ON</p> <p>Factory setting OFF</p>
SIMULATION MEASURAND	<p>Description Use this function to set all the inputs, outputs and the totalizer to their flow-response modes, in order to check whether they respond correctly. During this time, the message #692 "SIMULATION MEASURAND" appears on the display.</p> <p> Note!</p> <ul style="list-style-type: none"> ▪ The measuring device can only be used for measuring to a certain extent while the simulation is in progress. ▪ The setting is not saved if the power supply fails. <p>Options OFF MASS FLOW CORRECTED VOLUME FLOW TEMPERATURE HEAT FLOW</p> <p>Factory setting OFF</p>
VALUE SIMULATION MEASURAND	<p>Prerequisite Function is only available if the SIMULATION MEASURAND function (→  76) is active.</p> <p>Description Use this function to specify an arbitrary value (e.g. 12 kg/s) to check the assigned functions in the device itself and downstream signal circuits. The unit depends on the option selected in the SIMULATION MEASURAND function and is taken from the SYSTEM UNITS group (→  9).</p> <p> Note! The setting is not saved if the power supply fails.</p> <p>User input 5-digit floating-point number</p> <p>Factory setting (country dependent →  79)</p> <ul style="list-style-type: none"> ▪ 0 kg/h; 0 lb/h (MASS FLOW) ▪ 0 Nm³/h; 0 Sm³/h (CORRECTED VOLUME FLOW) ▪ 0 kW; 0 kBtu (HEAT FLOW) ▪ 0 °C; +32 °F (TEMPERATURE)

24 SENSOR VERSION

Function description, SENSOR VERSION group	
SENSOR TYPE	<p>Description Use this function to view the sensor type.</p> <p>Display FLOWCELL (t-mass 65F flange sensor) INSERTION (t-mass 65I insertion sensor)</p>
SERIAL NUMBER	<p>Description The serial number of the sensor appears on the display.</p>
TRANSDUCER SERIAL NUMBER	<p>Description The serial number of the transducer appears on the display.</p>
SOFTWARE REVISION NUMBER S-DAT	<p>Description Use this function to view the software revision number of the S-DAT.</p>
PRE-AMPLIFIER SOFTWARE REVISION NUMBER	<p>Description Use this function to view the software revision number of the preamplifier.</p>
PRE-AMPLIFIER HARDWARE REVISION NUMBER	<p>Description Use this function to view the hardware revision number of the preamplifier.</p>

25 AMPLIFIER VERSION

Function description, AMPLIFIER VERSION group	
DEVICE SOFTWARE	Description Use this function to display the current device software version.
HARDWARE REVISION NUMBER AMPLIFIER	Description Use this function to view the hardware revision number of the amplifier board.
SOFTWARE REVISION NUMBER AMPLIFIER	Description Use this function to view the software revision number of the amplifier board.
SOFTWARE REVISION NUMBER T-DAT	Description Use this function to view the software revision number of the T-DAT.
I/O MODULE TYPE	Description Use this function to view the configuration of the I/O module.
SOFTWARE REVISION NUMBER I/O MODULE	Description Use this function to view the software revision number of the I/O module.
SUB-I/O MODULE TYPE	Description Use this function to view the configuration of the I/O submodule.
SOFTWARE REVISION NUMBER SUB-I/O TYPE	Description Use this function to view the software revision number of the corresponding submodule.

26 Factory settings

26.1 Language → 17

Country	Language	Country	Language
Australia	English	Norway	Norwegian
Belgium	English	Austria	German
Denmark	English	Poland	Polish
Germany	German	Portugal	Portuguese
England	English	Sweden	Swedish
Finland	Finnish	Switzerland	German
France	French	Singapore	English
The Netherlands	Dutch	Spain	Spanish
Hong Kong	English	South Africa	English
India	English	Thailand	English
Italy	Italian	Czechia	Czech
Luxembourg	French	Hungary	English
Malaysia	English	Other countries	English

26.2 SI units (not for USA and Canada)

26.2.1 Low flow cut off, full scale value, pulse value

t-mass F sensor

With air at ambient conditions (without a flow conditioner)

Nominal diameter [mm]	Low flow cut off [kg/h]	Full scale value [kg/h]	Pulse value [kg/p]
15	0.53	53	0.10
25	2.00	200	1.00
40	5.55	555	1.00
50	9.10	910	10.00
80	20.30	2030	10.00
100	37.50	3750	10.00

t-mass I sensor

With air at ambient conditions (without a flow conditioner)

Nominal diameter [mm]	Low flow cut off [kg/h]	Full scale value [kg/h]	Pulse value [kg/p]
80	20.30	2030	10.0
100	37.50	3750	10.0
150	75.00	7500	100.0
200	125.00	12500	100.0

Nominal diameter [mm]	Low flow cut off [kg/h]	Full scale value [kg/h]	Pulse value [kg/p]
250	200.00	20000	100.0
300	280.00	28000	100.0
400	500.00	50000	100.0
500	800.00	80000	100.0
600	1150.00	115000	100.0
700	1590.00	159000	100.0
1000	3200.00	320000	100.0
1500	7200.00	720000	100.0

26.2.2 System units → 9

	Unit
Temperature	°C
Density	kg/m ³
Reference density	kg/m ³
Calorific Value Mass	MJ/kg
Heat	kWh

	Unit
Length	mm
Pressure	bar a
Reference Pressure	bar a
Calorific Value Corr. Vol.	MJ/m ³
Reference temperature	°C

26.2.3 Unit totalizer 1 and 2 → 23

	Unit
Mass flow	kg
Heat flow	MWh

	Unit
Corrected volume flow	Nm ³

26.2.4 Other Units

	Unit
Ref. combustion temp.	°C
Pipe standard	according to DIN

→  68→  70

26.3 US units (only for USA and Canada)

26.3.1 Low flow cut off, full scale value, pulse value

t-mass F sensor

With air at ambient conditions; (without a flow conditioner)

Nominal diameter [mm]	Low flow cut off [lb/hr]	Full scale value [lb/hr]	Pulse value [lb/p]
½"	1.16	116	0.20
1"	4.40	440	2.00
1½"	12.20	1220	2.00
2"	20.02	2002	20.00
3"	44.66	4466	20.00
4"	82.50	8250	20.00

t-mass I sensor

With air at ambient conditions; (without a flow conditioner)

Nominal diameter [mm]	Low flow cut off [lb/hr]	Full scale value [lb/hr]	Pulse value [lb/p]
3"	44.66	4466	20.00
4"	82.50	8250	20.00
6"	165.00	16500	200.00
8"	275.00	27500	200.00
10"	440.00	44000	200.00
12"	610.00	61000	200.00
16"	1100.00	110000	200.00
20"	1760.00	176000	200.00
24"	2530.00	253000	200.00
28"	3498.00	349800	200.00
40"	7040.00	704000	200.00
60"	15840.00	1584000	200.00

26.3.2 System units → 9

	Unit
Temperature	°F
Density	lb/ft ³
Reference density	lb/ft ³
Calorific Value Mass	kBtu/lb
Heat	kBtu

	Unit
Length	inch
Pressure	psi a
Reference Pressure	psi a
Calorific Value Corr. Vol.	kBtu/Sft ³
Reference temperature	°F

26.3.3 Unit totalizer 1 and 2 → 23

	Unit
Mass flow	lb
Heat flow	kBtu

	Unit
Corrected volume flow	Sm ³

26.3.4 Other Units

	Unit
Ref. combustion temp.	°F
Pipe standard	according to ANSI

→  68→  70

Index

Numerics

100% VALUE LINE 1 (fct.)	20
100% VALUE LINE 2 (fct.)	20

A

ACCESS CODE (fct.)	17
ACCESS CODE COUNTER (fct.)	18
ACTIVE LEVEL (fct.)	52
ACTUAL CURRENT (fct.)	28
ACTUAL CURRENT INPUT (fct.)	55
ACTUAL FREQUENCY (fct.)	36
ACTUAL STATUS (fct.)	45
ACTUAL STATUS INPUT (fct.)	52
ACTUAL STATUS RELAY (fct.)	49
ACTUAL SYSTEM CONDITION (fct.)	74
ALARM DELAY (fct.)	75
AMPLIFIER HARDWARE REVISION NUMBER (fct.)	78
AMPLIFIER VERSION, function group	78
ANALYZER INPUT (fct.)	63
ASSIGN CURRENT (fct.)	25
ASSIGN CURRENT INPUT (fct.)	54
ASSIGN FREQUENCY (fct.)	30
ASSIGN GAS GROUP	
CURRENT OUTPUT (fct.)	25
FREQUENCY (fct.)	30
PULSE (fct.)	37
TOTALIZERS (fct.)	22
ASSIGN LINE 1 (fct.)	19
ASSIGN LINE 2 (fct.)	19
ASSIGN LOW FLOW CUTOFF (fct.)	59
ASSIGN PROCESS ERROR (fct.)	74
ASSIGN PULSE (fct.)	37
ASSIGN RELAY (fct.)	47
ASSIGN STATUS (fct.)	44
ASSIGN STATUS INPUT (fct.)	52
ASSIGN TOTALIZER (fct.)	22
ASSIGNMENT SYSTEM ERROR (fct.)	74

B

BACKLIGHT (fct.)	21
------------------	----

C

CALIBRATION DATE (fct.)	73
CALORIFIC VALUE TYPE (fct.)	67
CHECK VALUES (fct.)	66
COMMUNICATION, function group	56
CONTRAST LCD (fct.)	21
CORRECTED VOLUME FLOW (fct.)	8
CORRECTION FACTOR (fct.)	65
CURRENT INPUT, function group	54
CURRENT OUTPUT 1/2, function group	25
CURRENT SPAN (fct.)	25, 54

D

DEFINE PRIVATE CODE (fct.)	17
DESCRIPTION (fct.)	64
DEVICE ID (fct.)	56

DEVICE REVISION (fct.)	57
DEVICE SOFTWARE (fct.)	78
DISPLAY DAMPING (fct.)	20

E

END VALUE FREQUENCY (fct.)	31
ERROR CATEGORY (fct.)	74

F

FACTOR ARBITRARY MASS (fct.)	14
FAILSAFE MODE	
CURRENT OUTPUT (fct.)	28
FREQUENCY (fct.)	35
PULSE (fct.)	42
TOTALIZERS (fct.)	24
FAILSAFE VALUE (fct.)	36, 55
FIELD BUS ADDRESS (fct.)	56
FLOW CONDITIONER (fct.)	73
FLOW DAMPING (fct.)	69
FORMAT (fct.)	20

G

GAS TYPE 1 (fct.)	64
GAS TYPE 2 to 8 (fct.)	65
GAS, function group	62
GROSS CALORIFIC VALUE (fct.)	59

H

HANDLING TOTALIZER, function group	24
HART PROTOCOL (fct.)	56
HEAT FLOW (fct.)	8
HEAT FLOW, function group	67
HEATING VALUE 1 (fct.)	67
HOURS SINCE RESET (fct.)	75

I

I/O MODULE (fct.)	78
I/O-MODULE SOFTWARE REVISION NUMBER (fct.)	78
INSERTION DEPTH (fct.)	72
INSTALLATION FACTOR (fct.)	61
INTERNAL DIAMETER (fct.)	71
INTERNAL HEIGHT (fct.)	71
INTERNAL WIDTH (fct.)	72

L

LANGUAGE (fct.)	17
-----------------	----

M

MANUFACTURER ID (fct.)	56
MASS FLOW (fct.)	8
MEASURED VALUES, function group	8
MINIMUM PULSE WIDTH (fct.)	52
MODE 1 (fct.)	67
MODE 2 (fct.)	67
MOLE % GAS 1 (fct.)	59, 64
MOLE % GAS 2 to 8	66
MOUNTING (fct.)	72

MOUNTING SET LENGTH (fct.)	72	SIMULATION CURRENT (fct.)	28
N		SIMULATION CURRENT INPUT (fct.)	55
NET CALORIFIC VALUE (fct.)	59	SIMULATION FAILSAFE MODE (fct.)	76
NOMINAL DIAMETER (fct.)	70	SIMULATION FREQUENCY (fct.)	36
NUMBER OF GASES (fct.)	63	SIMULATION MEASURAND (fct.)	76
O		SIMULATION PULSE (fct.)	43
OFF-VALUE LOW FLOW CUTOFF (fct.)	60	SIMULATION STATUS INPUT (fct.)	52
ON-VALUE LOW FLOW CUTOFF (fct.)	60	SIMULATION SWITCH POINT (fct.)	46
OPERATING MODE (fct.)	30	SIMULATION SWITCHPOINT (fct.)	49
OPERATING PRESSURE (fct.)	58	SIMULATION SYSTEM, function group	76
OPERATION HOURS (fct.)	75	SOFTWARE REVISION NUMBER AMPLIFIER (fct.)	78
OPERATION, function group	17	SOFTWARE REVISION NUMBER S-DAT (fct.)	77
OUTER DIAMETER (fct.)	71	SOFTWARE REVISION NUMBER SUB-I/O TYPE (fct.)	78
OUTPUT SIGNAL		SOFTWARE REVISION NUMBER T-DAT (fct.)	78
FREQUENCY (fct.)	32–35	SPECIAL UNITS, function group	14
PULSE (fct.)	39–42	START VALUE FREQUENCY (fct.)	30
OVERFLOW (fct.)	22	STATUS ACCESS (fct.)	17
P		STATUS INPUT, function group	52
PIPE STANDARD (fct.)	70	SUB-I/O MODULE TYPE (fct.)	78
PIPE TYPE (fct.)	70	SUM (fct.)	22
POSITIVE ZERO RETURN (fct.)	69	SUPERVISION, function group	74
PRE-AMPLIFIER HARDWARE REVISION NUMBER (fct.)	77	SWITCH-OFF DELAY (fct.)	48
PRE-AMPLIFIER SOFTWARE REVISION NUMBER (fct.)	77	SWITCH-OFF POINT (fct.)	45, 48
PREVIOUS SYSTEM CONDITION (fct.)	74	SWITCH-ON DELAY (fct.)	48
PROCESS PARAMETER, function group	58	SWITCH-ON POINT (fct.)	44, 47
PROCESS PRESSURE 1 (fct.)	58	SYSTEM PARAMETER, function group	69
PROCESS PRESSURE 2 (fct.)	58	SYSTEM RESET (fct.)	75
PULSE VALUE (fct.)	37	SYSTEM UNITS, function group	9
PULSE WIDTH (fct.)	38	T	
PULSE, FREQUENCY, STATUS, function group	30	TAG DESCRIPTION (fct.)	56
Q		TAG NAME (fct.)	56
QUICK SETUP COMMISSIONING (fct.)	15	T-DAT save/load	16
QUICK SETUP function group	15	T-DAT SAVE/LOAD (fct.)	16
QUICK SETUP GAS (fct.)	15	TEMPERATURE (fct.)	8
QUICK SETUP HEAT FLOW (fct.)	15	TEST DISPLAY (fct.)	21
QUICK SETUP PRESSURE (fct.)	15	TEXT ARBITRARY MASS (fct.)	14
QUICK SETUP SENSOR (fct.)	15	TIME CONSTANT	
R		CURRENT OUTPUT (fct.)	28
REFERENCE COMBUSTION TEMPERATURE (fct.)	68	FREQUENCY (fct.)	35
REFERENCE DENSITY (fct.)	59, 65	RELAY OUTPUT (fct.)	48
REFERENCE PRESSURE (fct.)	58	STATUS (fct.)	45
REFERENCE TEMPERATURE (fct.)	59	TOTALIZER 1/2, function group	22
RELAY OUTPUT 1/2, function group	47	TRANSDUCER SERIAL NUMBER (fct.)	77
RESET ALL TOTALIZERS (fct.)	24	U	
RESET TOTALIZER (fct.)	23	UNIT CALORIFIC VALUE CORRECTED VOLUME (fct.)	11
S		UNIT CALORIFIC VALUE MASS (fct.)	10
SAVE CHANGES (fct.)	66	UNIT CORRECTED VOLUME (fct.)	10
SELECT GROUP (fct.)	63	UNIT CORRECTED VOLUME FLOW (fct.)	10
SENSOR DATA, function group	70	UNIT DENSITY (fct.)	13
SENSOR TYPE (fct.)	77	UNIT HEAT (fct.)	12
SENSOR VERSION, function group	77	UNIT HEAT FLOW (fct.)	11
SERIAL NUMBER (fct.)	77	UNIT LENGTH (fct.)	13
		UNIT MASS (fct.)	9
		UNIT MASS FLOW (fct.)	9
		UNIT PRESSURE (fct.)	12
		UNIT TEMPERATURE (fct.)	12
		UNIT TOTALIZER (fct.)	23

USER INTERFACE, function group 19

V

VALUE 0_4 mA (fct.) 26, 54
 VALUE 20 mA (fct.) 27, 54
 VALUE SIMULATION CURRENT (fct.) 29
 VALUE SIMULATION CURRENT INPUT (fct.) 55
 VALUE SIMULATION FREQUENCY (fct.) 36
 VALUE SIMULATION MEASURAND (fct.) 76
 VALUE SIMULATION PULSE (fct.) 43
 VALUE SIMULATION STATUS INPUT (fct.) 53
 VALUE SIMULATION SWITCH POINT (fct.) 46, 49
 VALUE-f HIGH (fct.) 32
 VALUE-f LOW (fct.) 31

W

WALL THICKNESS (fct.) 71
 WRITE PROTECTION (fct.) 56

Z

ZERO POINT (fct.) 73
 ZERO POINT ADJUST (fct.) 60

www.addresses.endress.com
