

**NEW**









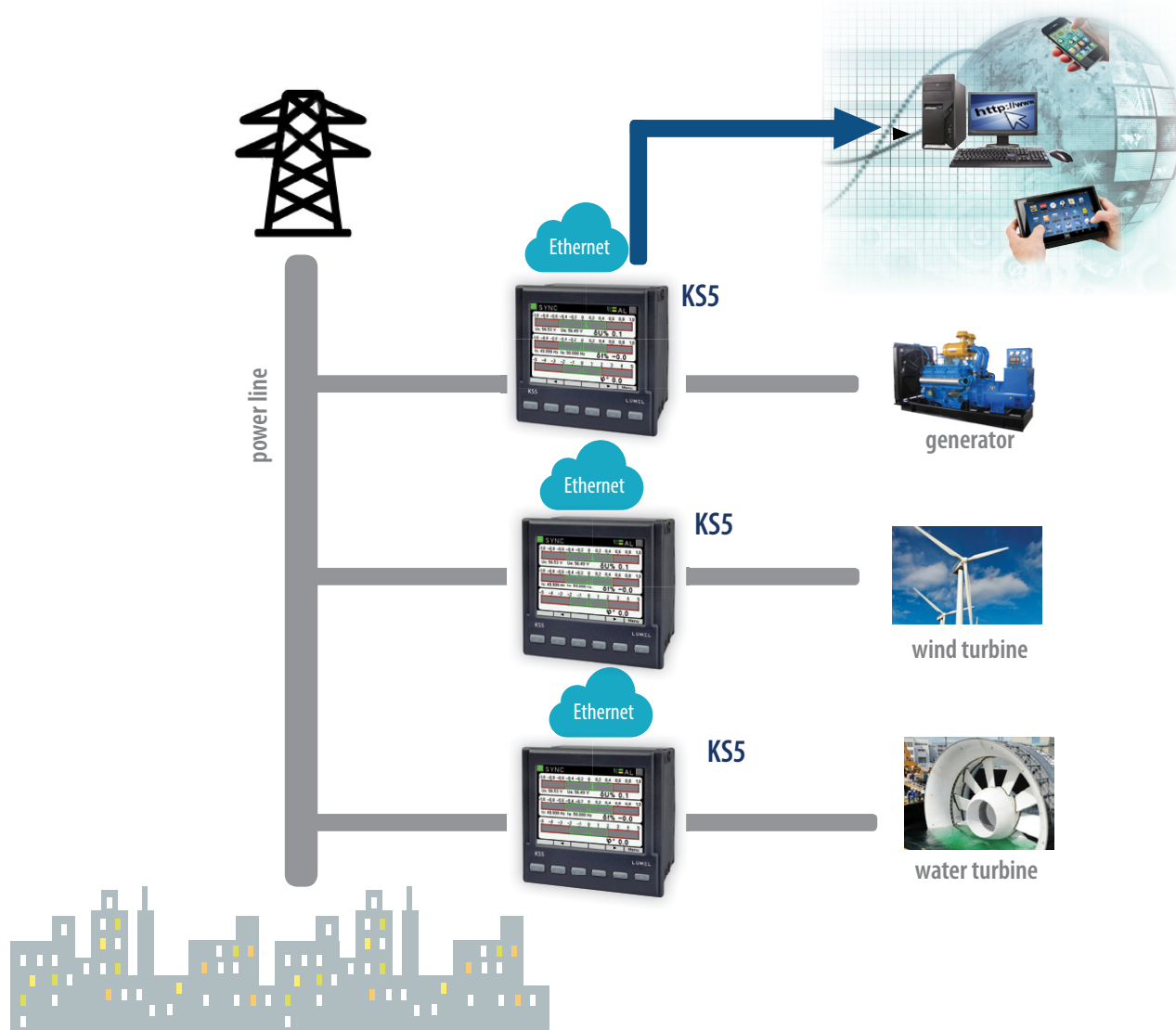

## KS5 - SYNCHRONIZATION METER

- Clear data visualization thanks to color graphic display 3.5" TFT (separately for the synchroscope, differential voltmeter, frequency meter);
- Range of input signals: 50...150 V or 150...400 V;
- Direct or indirect measurement through voltage transformers;
- Additional control inputs: BLK - lock synchronization, START - start synchronization
- Programmable hysteresis of voltage difference, frequency, and phase shift angle
- **Ethernet interface 10/100 BASE-T** for connecting the synchronization meter to the local area network (LAN) or the global one (WAN);
- Network services: web server, Modbus TCP / IP, DHCP server;
- RS-485 interface with Modbus RTU protocol;
- Password protection for two accounts of Web Server user,
- Measurement of the minimum and maximum values of voltage and frequency
- External dimensions: 96 x 96 x 77mm.

### EXAMPLE OF APPLICATION

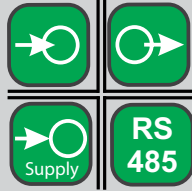

FEATURES	INPUTS	OUTPUTS	GALVANIC ISOLATION
 	  	  	

## TECHNICAL DATA

### MEASURING RANGE

Measured value	Measuring range	Resolution	Class/ basic error
Voltage Un: 50 ... 150 V~ 150 ... 400 V~	20 ... 180 V 60 ... 480 V ... 1920 kV (tr_U≠1)	0.1 V 0.1 V 0.01 kV	0.2 (EN 61557-12)
Voltage difference ΔU	-20..0..20 %	0.1%	0.5 (EN 61557-12)
Frequency f	45 ..65 Hz	0.001 Hz	0.02 (EN 61557-12)
Frequency difference Δf	-10..0..10 %	0.01%	0.02 (EN 61557-12)
Phase shift φ	0..360°	0.1°	±0.5°

tr\_U - ratio of voltage transformer = transformer primary voltage / transformer secondary voltage

### INPUTS

Input type	Properties
Control inputs (BLK, START)	2 voltage input 20..250 V d.c./a.c. Power consumption per input ≤ 0.25 W

### OUTPUTS

Output type	Properties
Relay outputs (AL, SYNC)	2 programmable relays, NO contacts, resistance load 0.5 A/250 V a.c. or 5 A/30 V d.c.; activation time of the relay - max. 8 ms; number of switching: mechanical - minimum 5 x 10 <sup>6</sup> , electrical - minimum 1 x 10 <sup>5</sup>

### DIGITAL INTERFACE

Interface type	Transmission protocol	Remarks
RS-485	Modbus RTU 8N2, 8E1, 8O1, 8N1 Adres 1..247	baud rate: 4.8, 9.6, 19.2, 38.4, 57.6, 115.2 kbit/s
Ethernet 10/100 Base-T	Modbus TCP/IP, DHCP client	RJ45 socket, WWW server

### EXTERNAL FEATURES

Readout field	graphic color display LCD TFT 3,5", 320 x 240 pixels	
Overall dimensions	96 x 96 x 77 mm	mounting hole 92.5 x 92.5 mm
Weight	0.3 kg	
Protection grade	from frontal side: IP65	from terminal side: IP20

## RATED OPERATING CONDITIONS

Supply voltage	→ 85..253 V a.c. (40..50..400) Hz or 90..300 V d.c. or 20..40 V a.c. (40..50..400) Hz or 20..60 V d.c.	
Power consumption	in supplying circuit ≤ 6 VA	in voltage circuit ≤ 0.5 VA
Input signal	0.2..0.4..1.2 U <sub>n</sub>	frequency 45..50..60..65 Hz, sinusoidal (THD ≤ 8%)
Phase shift	0 .. 360° for frequency f <sub>n</sub> ± 5 Hz (for f <sub>n</sub> = 50 or 60 Hz)	
Preheating time	15 min.	
Ambient temperature	-10 .. 23 .. 55°C, class K55 acc. to EN 61557-12	
Humidity	0..40..65 .. 95%	without condensation
Operating position	any	
External magnetic field	≤ 40 .. 400 A/m d.c.	≤ 3 A/m a.c. 50/60 Hz
Short-term overload	voltage input: 2 U <sub>n</sub> (5 sek.)	
Admissible crest factor	current: 2	

## SAFETY AND COMPABILITY REQUIREMENTS

Electromagnetic compatibility	noise immunity	acc. to EN 61000-6-2
	noise emissions	acc. to EN 61000-6-4
Isolation insured by the casing	double	acc. to EN 61010-1
Isolation between circuits	basic	acc. to EN 61010-1
Pollution level	2	acc. to EN 61010-1
Installation category	III for phase-to-earth voltages up to 300 V	acc. to EN 61010-1
Maximal phase-to-earth voltage	<ul style="list-style-type: none"> <li>for supplying circuits and relay outputs 300 V</li> <li>for measuring inputs 300 V</li> <li>for circuits RS-485, Ethernet: 50 V</li> </ul>	acc. to EN 61010-1
Altitude a.s.l.	< 2000 m	

## CONNECTION DIAGRAMS

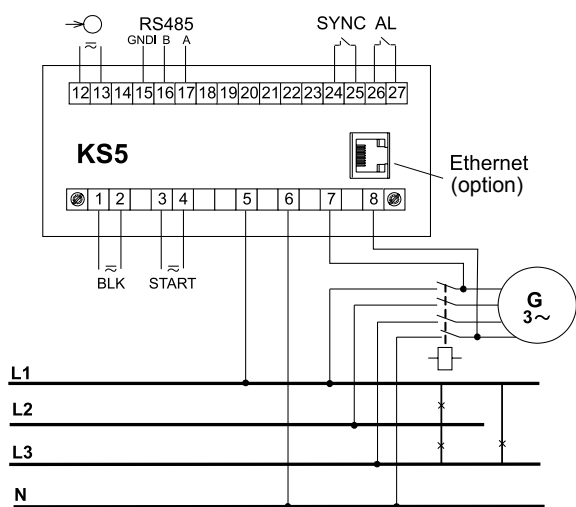

Meter connections - measurement phase voltages

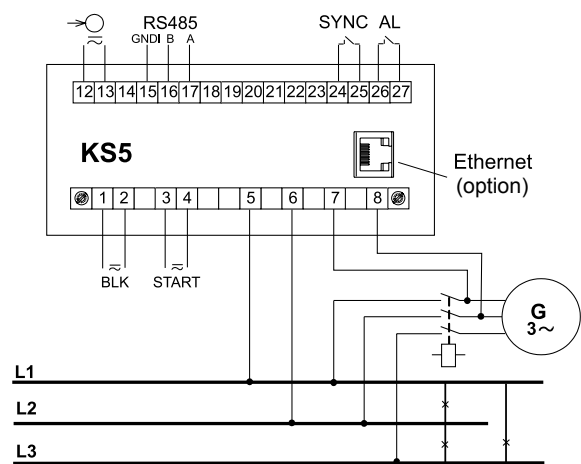

Meter connections - measurement phase-to-phase voltages

## DISPLAYING OF MEASUREMENTS PARAMETERS

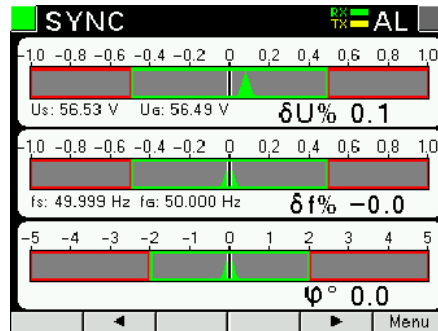
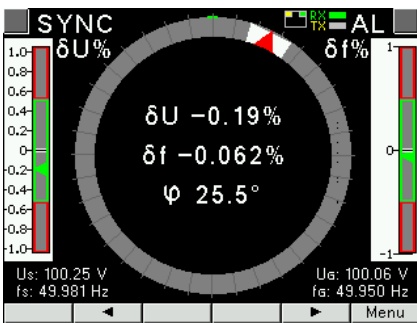

Visualization of measurement  
(synchroscop, bargraphs)

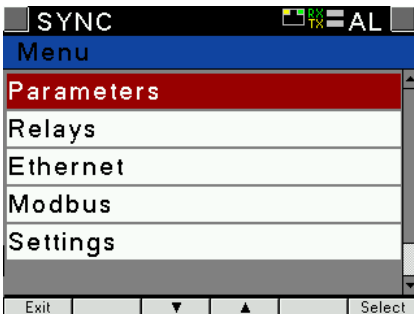

easy to use and intuitive menu

## METER CONFIGURATION WITH FREE eCON SOFTWARE

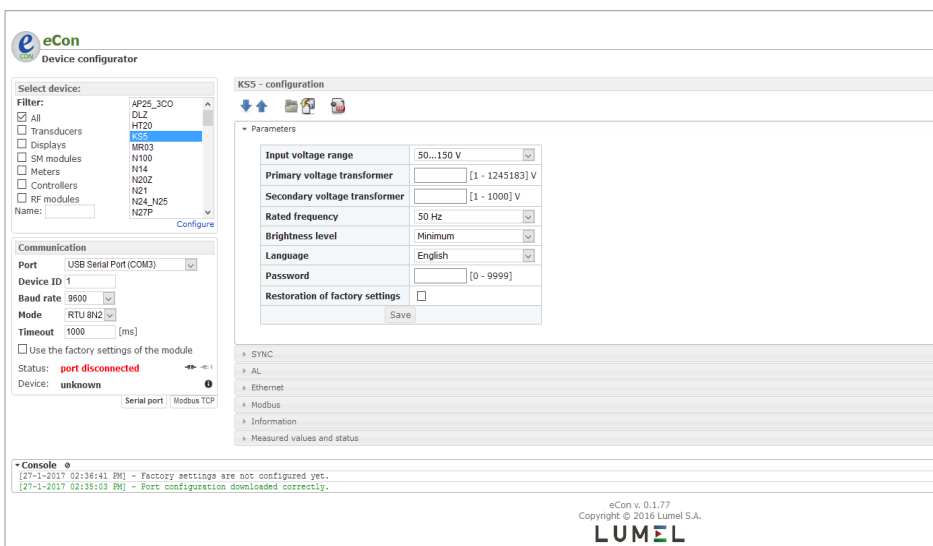

ability to configure and update KSS  
with free eCon software  
(via RS-485 or Ethernet interface)

## REMOTE READOUT OF PARAMETERS THROUGH ETHERNET: WWW SERVER

**LUMEL**  
EVERYTHING COUNTS  
KS5 synchronization meter

Us: <b>100.05</b> V	$\delta U$ : <b>-1.56</b> %	Minimum Us: <b>99.60</b> V	Maximum Us: <b>100.59</b> V
Ug: <b>98.50</b> V	$\delta f$ : <b>-0.088</b> %	Ug: <b>96.56</b> V	Ug: <b>98.60</b> V
fs: <b>50.002</b> Hz	$\phi$ : <b>8.0</b> °	fs: <b>49.998</b> Hz	fs: <b>50.006</b> Hz
fG: <b>49.958</b> Hz		fG: <b>49.586</b> Hz	fG: <b>49.960</b> Hz

**Ethernet**  
 Ip: 192.168.0.33  
 Mask: 255.255.255.0  
 Gate: 192.168.0.1  
 DHCP: On

**Modbus**  
 Id: 1  
 Baud rate: 9600 b/s  
 Control: 8N2

**AL**  
 SYNC

**About**   **Settings**   **Log out**

Copyright © 2016, Lumel S.A. All rights reserved.

WEB server for remote reading of current measurement data

## ORDERING CODE

	KS5 -	X	X	X	XX	X	X
<b>Input voltage Un*:</b>							
50...150 V		1					
150...400 V		2					
<b>Interface:</b>							
RS-485			1				
RS-485 and Ethernet			2				
<b>Supply:</b>							
85...253 V a.c., 90...300 V d.c.				1			
20...40 V a.c., 20...60 V d.c.				2			
<b>Version:</b>							
standard					00		
custom-made**					XX		
<b>Language:</b>							
Polish						P	
English						E	
other**						X	
<b>Acceptance tests:</b>							
without additional quality requirements							0
with an extra quality inspection certificate							1
acc.to customer's request							X

\* Un - phase and phase-to-earth voltage (programmable in selected range); maximal phase-to-earth voltage 300 V,  
 \*\* after agreeing with the manufacturer

**Order example:**

The code: **KS5-1 2 1 00 E 0** means:

- KS5 –synchronization meter
- 1 – input voltage 50...150 V,
- 2 – RS485 and Ethernet,
- 1 –supply 85..253 V a.c., 90..300 V d.c.
- 00 – standard version,
- E - user's manual in English
- 0 - without additional quality requirements.

For more information about Lumel products please visit our website:  
[www.lumel.com.pl](http://www.lumel.com.pl)

Join us at Facebook!



**LUMEL S.A.**  
 ul. Sulechowska 1, 65-022 Zielona Góra, POLAND  
 tel.: +48 68 45 75 100, fax +48 68 45 75 508  
 www.lumel.com.pl

**Export department:**  
 tel.: (+48 68) 45 75 139, 45 75 233, 45 75 321, 45 75 386  
 fax.: (+48 68) 32 54 091  
 e-mail: export@lumel.com.pl